



aerospace
climate control
electromechanical
filtration
fluid & gas handling
hydraulics
pneumatics
process control
sealing & shielding



Air Preparation & Airline Accessories

Catalogue PDE2611TCUK November 2010



ENGINEERING YOUR SUCCESS.

Parker Global Air Preparation System

Introduction 8-17

Combos

 P31 Mini Series 18

 P32 Compact Series 19

 P33 Standard Series 20

Filters

 P31 Mini Series 22-23

 P32 Compact Series 24-25

 P33 Standard Series 26-27

Coalescing & Adsorber Filters

 P31 Mini Series 28-29

 P32 Compact Series 30-31

 P33 Standard Series 32-33

Regulators

 P31 Mini Series 34-35

 P31 Mini Common Port Regulator 36-37

 P32 Compact Series 38-39

 P32 Compact Common Port Regulator 40-41

 P33 Standard Series 42-43

Filter / Regulators

 P31 Mini Series 44-45

 P32 Compact Series 46-47

 P33 Standard Series 48-49

Lubricators

 P31 Mini Series 50-51

 P32 Compact Series 52-53

 P33 Standard Series 54-55

Combined Soft Start Dump Valve and Remote Operated Dump Valve 56-57

Remote Operated Dump Valve 58-59

Soft Start Dump Valve 60-61

Solenoid Operators 62-63

Safety Lockout Valve 64

Manifold Blocks 65

Accessories

 P31 Mini Series 66

 P32 Compact Series 67

 P33 Standard Series 68

 Accessories Kits 69-70



WARNING

FAILURE OR IMPROPER SELECTION OR IMPROPER USE OF THE PRODUCTS AND/OR SYSTEMS DESCRIBED HEREIN OR RELATED ITEMS CAN CAUSE DEATH, PERSONAL INJURY AND PROPERTY DAMAGE.

This document and other information from Parker Hannifin Corporation, its subsidiaries and authorized distributors provide product and/or system options for further investigation by users having technical expertise. It is important that you analyze all aspects of your application and review the information concerning the product or system in the current product catalog. Due to the variety of operating conditions and applications for these products or systems, the user, through its own analysis and testing, is solely responsible for making the final selection of the products and systems and assuring that all performance, safety and warning requirements of the application are met. The products described herein, including without limitation, product features, specifications, designs, availability and pricing, are subject to change by Parker Hannifin Corporation and its subsidiaries at any time without notice.

SALE CONDITIONS

The items described in this document are available for sale by Parker Hannifin Corporation, its subsidiaries or its authorized distributors. Any sale contract entered into by Parker will be governed by the provisions stated in Parker's standard terms and conditions of sale (copy available upon request).

P3X Series Moduflex Lite Air Preparation System

Popular combinations	73
Filters	74 - 75
Coalescing filters	76 - 77
Adsorber filters	78 - 79
Regulators	80 - 81
Filter regulators	82 - 83
Lubricators	84 - 85
Modular slide valve	86
Modular manifold	86
Accessories	87

P3X Membrane Dryers

P3X Membrane Dryers	89
---------------------------	----

P3Y Series Air Preparation System

Recommended wall mountings	98
Popular combinations	99
Filters	100 - 101
Dust Filters	102 - 103
Coalescing filters	104 - 105
Adsorber filters	106 - 107
Regulators	108 - 109
Filter regulators	110 - 111
Lubricators	112 - 113
Proportional pressure regulator	114 - 115
Combined soft start dump valve	116 - 117
Remote operated dump valve	116 - 117
Soft Start valve	118 - 119
Pilot operated regulator	120 - 121
Modular ball valve	122
Modular manifold	123
Optional port block kits	123
Solenoid coils	124
Accessories	125

P3Z Series Air Preparation System

Filter / Dust Filter	128 - 129
Coalescing Filter / Adsorber Filter	130 - 131
Regulator / Pilot Regulator	132 - 133
Lubricator	134 - 135
Modular Manifold	136
Connection Flange Kits	136
Accessories	137

Moduflex Proportional Technology

Order Key.....	143
Popular Options.....	144
Technical Information.....	147
Parameter Settings.....	150 - 155
Trouble Shooting.....	156
Dimensions.....	157 - 159

Moduflex Compressed Air Filters

High Efficiency 0.01 µm Filtration.....	168 - 169
1 µm Filtration.....	170 - 171
Oil Vapour Removal Filter.....	172 - 173
High Efficiency Bulk Liquid Removal.....	174 - 175
ISO 8573 Compressed Air Quality Standards.....	176

Moduflex Dry Air System

Features.....	178 - 183
Technical Specifications.....	184 - 185
Weights and Dimensions.....	186

Moduflex AirGuard Protection System

Technical Data & Ordering Information.....	190
Selection Chart.....	191

Miniature FRL Series

14F Filters.....	194 - 195
10F Coalescing Filters.....	196 - 197
14R Regulators.....	198 - 199
14E Filter Regulators.....	200 - 201
04L Mist Lubricator.....	202 - 203
Mounting Bracket Kits.....	204

Stainless Steel FRLs

PF504 Filter - Miniature.....	206 - 207
PF501 Coalescing Filter - Miniature.....	208 - 209
PR354, PR364 Regulator - Miniature.....	210 - 211
PB548, PB558 Filter Regulator - Miniature.....	212 - 213
PF10 Filter - Standard.....	214 - 215
PF11 Coalescing Filter - Standard.....	216 - 217
PR10, PR11 Regulator - Standard.....	218 - 219
PB11, PB12 Filter Regulator - Standard.....	220 - 221
PL10 Lubricator - Standard.....	222 - 223

P3N 1" Modular Hi Flow FRLs

Combinations.....	227
Filters.....	228
Coalescing and Adsorber Filters.....	229
Regulators.....	230
Filter/Regulators.....	231
Lubricators.....	232
Air Pilot Regulators.....	233
Lubrication of Airlines.....	234

High Precision Regulators

R210 / 220 High Precision Regulators.....	236 - 237
R230 High Flow Precision Regulators.....	238 - 239

Control Accessories

Speed Flow Control Valves - PTFL4/8PB.....	242
Speed Flow Control Valves - PTF4/8PB.....	243
Speed Flow Control Valves - PTF4/8E6PB.....	244
Micrometer & Heavy Duty Inline Flow Control Valves.....	245
Speed Flow Control Valves - VQB.....	246
Speed Flow Control Valves - PWR-L.....	247
Terminal Block Sub-Bases.....	247
Blockers and Blocker/Flow Regulators - PWB/PWR-HB.....	248 - 249
Back Pressure Sensors - Modular - PWS.....	250
Back Pressure Sensors - Mono Block - PWS.....	251
Optimisers - PWP.....	252
Soft Start - PWD.....	253
Quick Exhaust Valves - P4Q.....	254
Non Return Valves VB / PWA / 3047.....	255
Shuttle Valves.....	256
Quick Acting Couplers - Schrader Original.....	257 - 259
Quick Acting Couplers - Schrader Mini.....	260 - 261
Exhaust Silencers.....	262 - 265
600 - 601 Blowguns.....	266



Parker Global Air Preparation System

A complete air preparation system

Parker Global Air Preparation System

Global.
Economical.
Modular.



*Performance you need,
wherever you need it.*



The comprehensive Global Air Preparation System is available in three body sizes with either BSPP or NPT to accommodate thread type requirements.

Full featured filters, regulators, filter/regulators, and lubricators are available with a wide range of standard options to meet air preparation needs.

Individual units can easily be assembled into various combinations, utilizing patented modular lightweight body connectors.

www.parker.com/globalfrl

Comprehensive Offering



P31 Mini Series
1/4" ports
40mm body width



P32 Compact Series
1/4", 3/8" and 1/2"
60mm body width



P33 Standard Series
1/2" and 3/4"
73mm body width



Filters

- 5 μ particulate, 1.0 μ and 0.01 μ coalescing, and adsorber available as standard
- Transparent or metal bowl with manual or auto float drains standard



Regulators

- Available as stand alone, common port and electronic proportional
- Both relieving and non-relieving versions available



Filter/Regulators

- Compact design for space savings
- Available with all the same standard options as the filters and regulators



Lubricators

- Proportional oil delivery over a wide range of air flows
- Fill under pressure



Combinations

- Compact design for space savings
- Easily assembled
- Many configurations available



Accessories





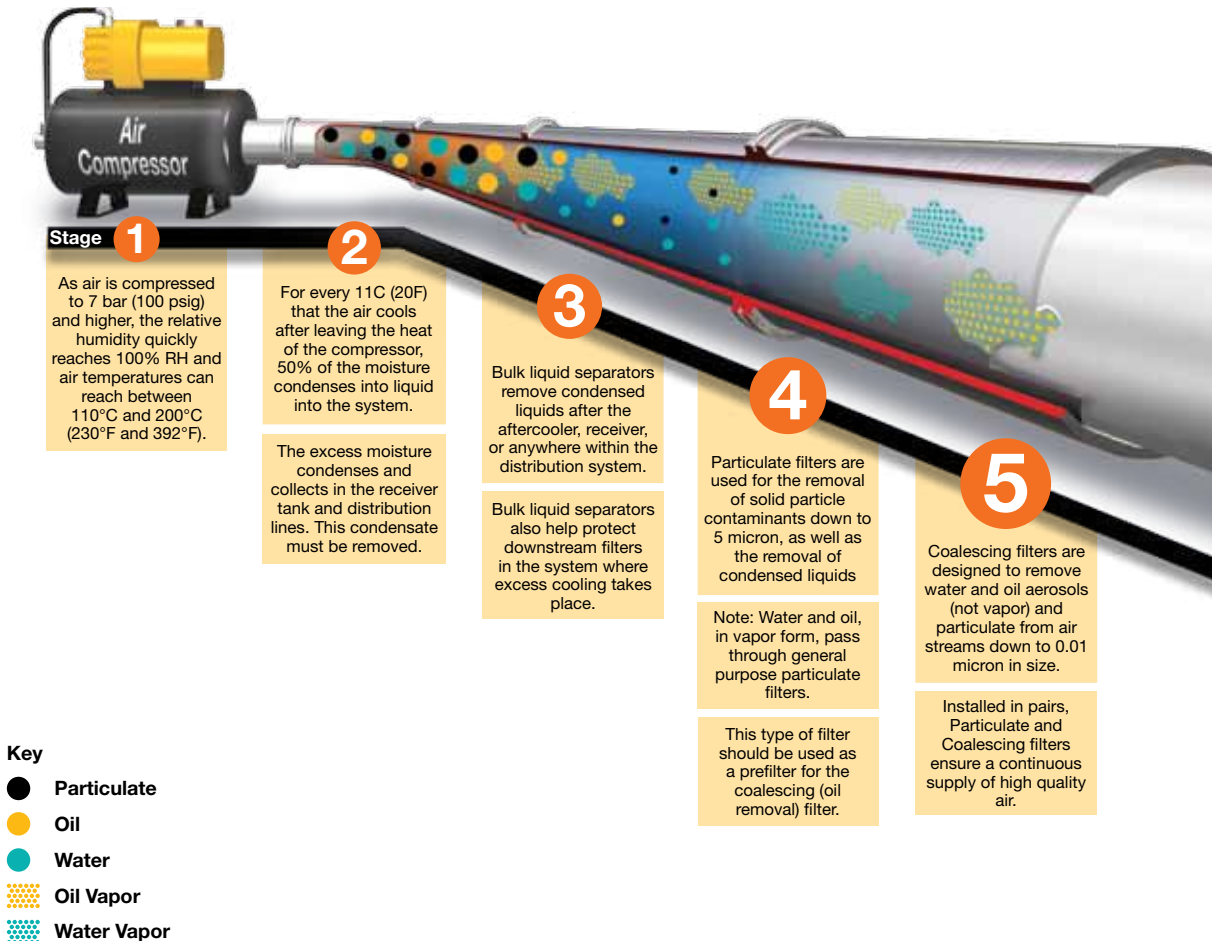

- Solenoid operated soft start, quick dump, and soft start/quick dump valves
- Manifold blocks
- Shut-off slide valves
- Service kits, gauges, etc.

Together we can power your application with clean, dry air

Fast cycle times, high product quality, and low downtime all require a clean, dry pneumatic system to function properly. Parker has what it takes to make sure pneumatic systems perform at their best.

Clean, dry pneumatic systems with Parker Global Air Preparation

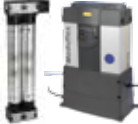

						
Stages	1 2	3	4	5	6	7
Function	Air Compressor	Bulk Liquid Removal	Particulate Filtration	Coalescing Filtration	Air Dryers	Hydrocarbon Removal
Application	All pneumatic systems	Basic pneumatic systems	Basic pneumatic systems	Systems requiring highest quality air.	Systems requiring air with reduced moisture content	Systems requiring highest quality air for critical applications
Description	Air leaving the compressor room at 93°C (200°F) releases 95% of its moisture into the piping system when it cools to 38°C (100°F)	Removes bulk liquid contamination and protects filters where excess cooling takes place in the distribution piping	Removes solid particulates down to 5 micron, and the separation of bulk contaminants.	Removes liquid aerosols and submicron particulates (not vapor) down to 0.01 micron.	Removes water vapor from air stream. Dew point reduced down to -40°C membrane and -70°C desiccant.	Removal of odors and trace vapors for critical applications.
Parker Global Air Preparation Solution	Customer supplied	P3TF Bulk Liquid Separator	P31, P32, P33 Particulate Filter	P31, P32, P33 Coalescing Filter	P3XJ Membrane Dryer P3TJ Regenerative Desiccant Dryer	P31, P32, P33 Activated Carbon (Adsorber) Filter



6

Refrigeration, membrane and desiccant dryers lower the air's dew point by removing water vapor, providing appropriately dry air for the downstream application.

7

Hydrocarbon and oil vapors are removed using filters utilizing activated carbon. These airborne hydrocarbons are often left over from the compressor oils.

**Clean
Dry Air**

A completely modular air preparation system

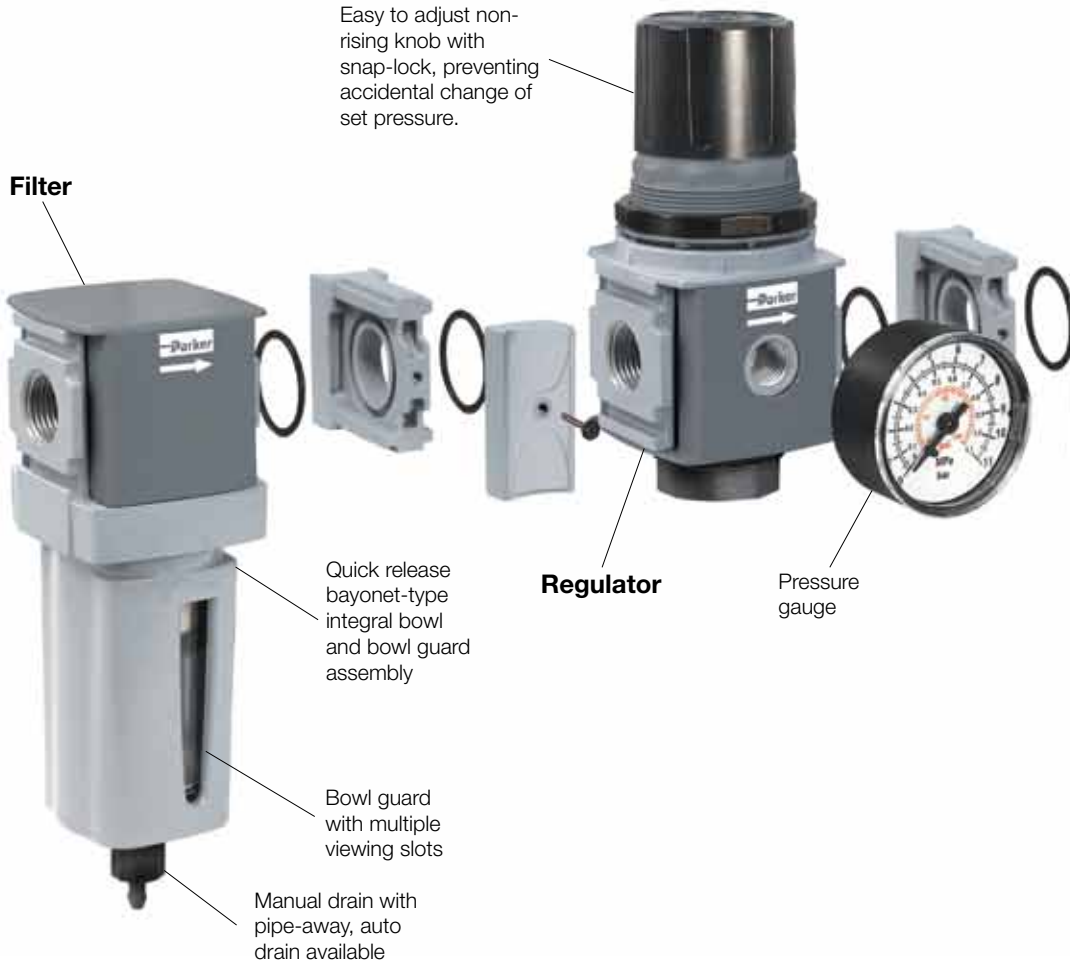

Electronic Proportional Regulator

- Electro-Pneumatic regulator
- Integrated systems control
- Accurate output pressure
- Micro parameter settings
- Selectable I/O parameters
- Quick, full flow exhaust
- LED display indicates output pressure
- No air consumption in steady state
- Multiple mounting options
- Protection to IP65



P31P Mini Series



P32P Compact Series

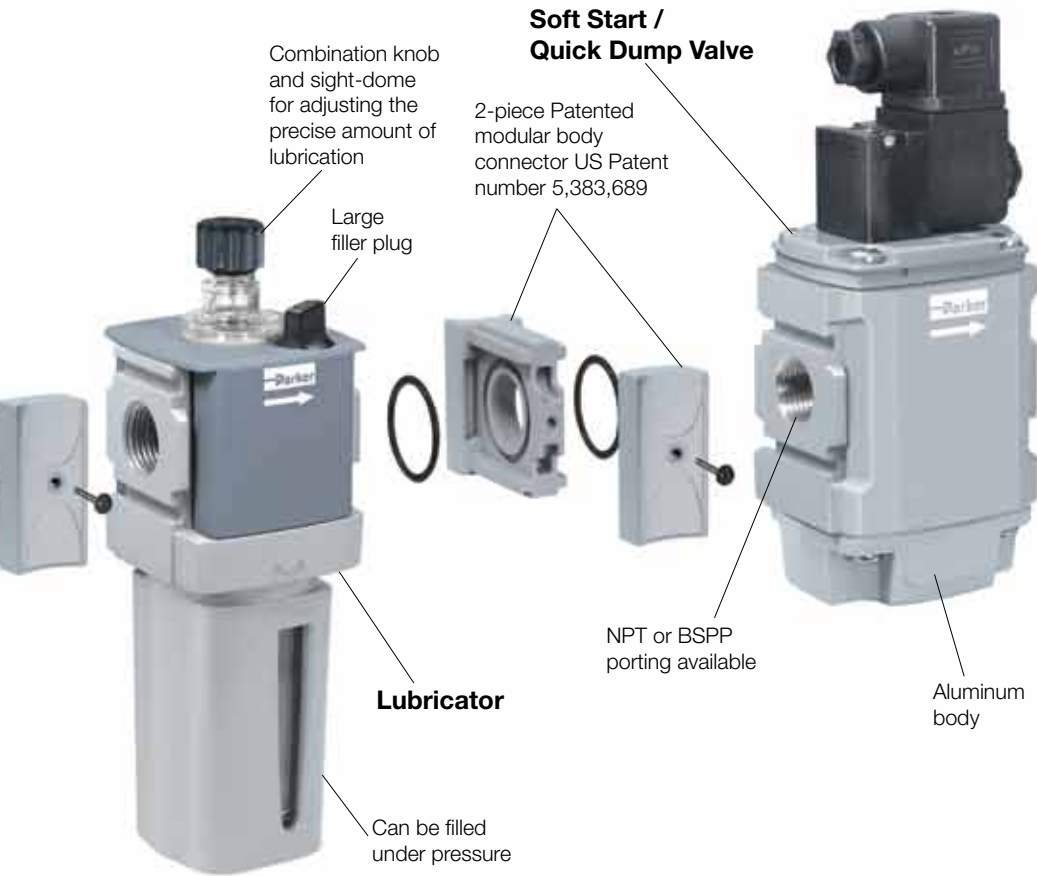

Common Port Manifold Regulators

- Multiple output pressures (P2, P3, P4, etc.) with common inlet (P1)
- Available in two sizes P31 and P32
- Balanced valve design for accurate pressure regulation
- Outlet pressure ports in front and rear of unit.
- Four spring ranges available



Air Preparation

P31 Mini Series

40mm body width
1/4" Ported

Flows up to:	dm ³ /s	(SCFM)
Filter	12	(25)
Coalescer	2	(4.2)
Regulator	30	(64)
Filter/Regulator	14	(30)
Lubricator	13	(28)

Features:

- Space saving integral gauge
- Manifold style regulators available
- OSHA compliant shut-off valves
- Soft-Start & Quick Dump valves
- Electronic Proportional Regulator



P32 Compact Series

60mm body width
1/4", 3/8", & 1/2" Ported

Flows up to:	dm ³ /s	(SCFM)
Filter	38	(80)
Coalescer	11	(23)
Regulator	67	(142)
Filter/Regulator	64	(136)
Lubricator	47	(100)

Features:

- Manifold style regulators available
- OSHA Compliant shut-off valves
- Soft-Start & Quick Dump valves
- Electronic Proportional Regulator



P33 Standard Series

73mm body width
1/2" & 3/4" Ported

Flows up to:	dm ³ /s	(SCFM)
Filter	48	(102)
Coalescer	20	(42)
Regulator	100	(212)
Filter/Regulator	98	(208)
Lubricator	68	(144)

Features:

- OSHA Compliant shut-off valves
- Soft-Start & Quick Dump valves (Utilizes P32 size only)
- Electronic proportional regulator (Utilizes P32 size only)



Valves and Actuators

Mini Series Complimentary Products

The P31 Mini Series FRL's and accessories are well matched for use with these Parker valves and actuators.



Isys Micro



Moduflex Size 1



OSP-P



P1D



P1A

Compact Series Complimentary Products

The P32 Series FRL's & accessories are well matched for use with these Parker valves and actuators.



Isys Micro



Isys HA / HB



P1D



OSP-P

Standard Series Complimentary Products

The P33 Series FRL's & accessories are well matched for use with these Parker valves and actuators.



Isys Size 1



Isys HA / HB



P1D



OSP-P

Complete Pneumatic System

Pressure Regulation

Accurate pressure regulation is important to control forces, speeds, torque, dispensing, processes, etc. Parker has a global solution to pressure regulation needs, with support around the world.



Function	Single	Common Port Manifold	Electronic Proportional
Description	For pneumatic systems requiring single pressure regulation.	For pneumatic systems requiring multiple pressures for different parts of the system, yet still having a common inlet supply.	For pneumatic systems requiring an electronic to pneumatic proportional control signal. Also allows pressure regulation to be integrated into your control systems.
Parker Global Air Preparation Solution	P31R, P32R, P33R	P31H, P32H	P31P, P32P fits Compact & Standard

Accessories

Today's sophisticated pneumatic systems need more than just FRL's. Often times peripheral accessory products are needed to complete pneumatic systems. Parker has what is needed to ensure safe and reliable start-ups, shut-downs, and lockouts, etc.



	Slide Valve	Soft Start / Quick Dump	Soft Start	Quick Dump	Manifold Block
Soft Start Function	⊘	✔	✔	⊘	⊘
Quick Dump Function	Slow Exhaust	✔	⊘	✔	⊘
Operation	Manual Slide	Solenoid or Air Pilot	Solenoid, Air Pilot, or Internal Air Pilot	Solenoid or Air Pilot	N/A
Placement	Before or after FRL, or stand alone	After FRL	After FRL	After FRL	Anywhere within FRL or stand alone
Parker Global Air Preparation Solution	P31V, P32V, P33V	P31T Mini, P32T fits Compact & Standard	P31S Mini, P32S fits Compact & Standard	P31D Mini, P32D fits Compact & Standard	P31M Mini, P33M fits Compact & Standard

Application Guide

FRL to Valve: The chart below contains recommendations for the correct selection of Global Air Preparation units to suit the number and size of valves in a typical application.

	P31 Mini Series				P32 Compact Series						P33 Standard Series					
	Number of valves that would actuate at once															
	1	2	3	4	5	6	7	8	9	10	11	12	13	14	15	16
Moduflex 1	Yellow	Yellow	Yellow	Yellow	Yellow	Green	Green	Green	Green	Green	Green	Green	Green	Green	Green	Green
Isys Micro	Yellow	Yellow	Yellow	Yellow	Green	Green	Green	Green	Green	Green	Green	Green	Green	Green	Green	Green
HB / Viking Xtreme	Yellow	Yellow	Yellow	Yellow	Green	Green	Green	Green	Green	Green	Green	Green	Green	Green	Green	Green
Moduflex 2	Yellow	Yellow	Yellow	Yellow	Yellow	Yellow	Yellow	Yellow	Yellow	Yellow	Yellow	Yellow	Yellow	Yellow	Yellow	Yellow
HA / Global ISO	Yellow	Yellow	Yellow	Yellow	Yellow	Yellow	Yellow	Yellow	Yellow	Yellow	Yellow	Yellow	Yellow	Yellow	Yellow	Yellow

See Larger Parker FRL Offering

Actuator to FRL: The chart below contains recommendations for the correct selection of Global Air Preparation units suitable for each cylinder size. If you have a tube length over 2 m, choose one tube size larger than the chart. The table is based on a maximum cylinder speed of 0.5m/s

Cyl Ø mm Cyl Ø inches	Cylinder bore size													
	5 (5/16)	10 (7/16)	16 (9/16)	20 (3/4)	25 (1)	28 (1-1/8)	32 (1-1/4)	40 (1-1/2)	45 (1-3/4)	50 (2)	63 (2-1/2)	75 (3)	80 (3-1/4)	100 (4)
	Tube diameter external													
Tube Ø mm Tube Ø inches	4 (5/32)	4 (5/32)	4 (5/32)	6 (1/4)	6 (1/4)	6 (1/4)	6 (1/4)	8 (5/16)	8 (5/16)	8 (5/16)	10 (3/8)	10 (3/8)	12 (1/2)	12 (1/2)
Number of cylinders actuating at once	1	Yellow	Yellow	Yellow	Yellow	Yellow	Yellow	Yellow	Yellow	Yellow	Yellow	Yellow	Yellow	Yellow
	2	Yellow	Yellow	Yellow	Yellow	Yellow	Yellow	Yellow	Yellow	Yellow	Yellow	Yellow	Yellow	Yellow
	3	Yellow	Yellow	Yellow	Yellow	Yellow	Yellow	Yellow	Yellow	Yellow	Yellow	Yellow	Yellow	Yellow
	4	Yellow	Yellow	Yellow	Yellow	Yellow	Yellow	Yellow	Yellow	Yellow	Yellow	Yellow	Yellow	Yellow
	5	Yellow	Yellow	Yellow	Yellow	Yellow	Yellow	Yellow	Yellow	Yellow	Yellow	Yellow	Yellow	Yellow
	6	Yellow	Yellow	Yellow	Yellow	Yellow	Yellow	Yellow	Yellow	Yellow	Yellow	Yellow	Yellow	Yellow
	7	Yellow	Yellow	Yellow	Yellow	Yellow	Yellow	Yellow	Yellow	Yellow	Yellow	Yellow	Yellow	Yellow
	8	Yellow	Yellow	Yellow	Yellow	Yellow	Yellow	Yellow	Yellow	Yellow	Yellow	Yellow	Yellow	Yellow
	9	Yellow	Yellow	Yellow	Yellow	Yellow	Yellow	Yellow	Yellow	Yellow	Yellow	Yellow	Yellow	Yellow
	10	Yellow	Yellow	Yellow	Yellow	Yellow	Yellow	Yellow	Yellow	Yellow	Yellow	Yellow	Yellow	Yellow

See Larger Parker FRL Offering

Note: Data listed above is simply a guideline for a typical application only. Proper sizing and correct flow requirements must be taken into account.

Popular Combinations : Inlet pressure 10 bar, Secondary pressure 6.3 bar, 1 bar pressure drop.

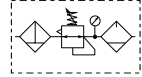

**Filter + Regulator + Lubricator Combinations + Poly bowl
5 micron element, 8 bar Regulator + Gauge and Wall Mounting Brackets**

Port size	Flow dm ³ /s (scfm)	Manual Drain	Weight	Pulse Drain	Weight
1/4"	13 27	P31CB12GEMNTLNW	0.46 kg (1.01 lbs)	P31CB12GEBNTLNW	0.46 kg (1.01 lbs)

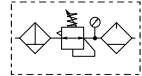

**Filter/Regulator + Lubricator Combinations + Poly bowl
5 micron element, 8 bar Regulator + Gauge and Wall Mounting Brackets**

Port size	Flow dm ³ /s (scfm)	Manual Drain	Weight	Pulse Drain	Weight
1/4"	14 28	P31CA12GEMNTLNW	0.35 kg (0.77 lbs)	P31CA12GEBNTLNW	0.35 kg (0.77 lbs)

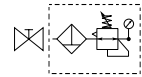

**Slide Valve + Filter/Regulator + Lubricator Combinations + Poly bowl
5 micron element, 8 bar Regulator + Gauge and Wall Mounting Brackets**

Port size	Flow dm ³ /s (scfm)	Manual Drain	Weight	Pulse Drain	Weight
1/4"	14 28	P31YA12GEMNTLNW	0.54 kg (1.19 lbs)	P31YA12GEBNTLNW	0.54 kg (1.19 lbs)

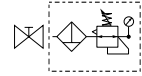

**Slide Valve + Filter/Regulator Combinations + Poly bowl
5 micron element, 8 bar Regulator + Gauge and Wall Mounting Brackets**

Port size	Flow dm ³ /s (scfm)	Manual Drain	Weight	Pulse Drain	Weight
1/4"	14 28	P31YN12GEMNTW	0.4 kg (0.88 lbs)	P31YN12GEBNTW	0.4 kg (0.88 lbs)

P 3 1					E		N		LN	W
Combination		Thread type	Port size		Drain type		Adjustment range		Add only for options with Lubricator	
Combination	C	BSPP	1	1/4	Manual drain	M	With square gauge			
Shut off + Combi ¹	Y	NPT	9	2	Pulse drain	B	2 bar *	V		
							4 bar	S		
							8 bar **	T		
Combination type		Bowl type					* Unit comes with 0-4 bar, gauge respectively			
F/R+L	A	Poly bowl with bowl guard		G			** Unit comes with 0-10 bar, gauge respectively			
F+R+L	B	Metal bowl without sight glass		M						
F/R	N						¹ Option not available with F+R+L			

Note: All bowl types are the same for each component

Example: If a "G" is specified for a F+L, both units would get a poly bowl with bowl guard.

Popular Combinations : Inlet pressure 10 bar, Secondary pressure 6.3 bar, 1 bar pressure drop.

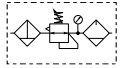

**Filter + Regulator + Lubricator Combinations + Poly bowl
5 micron element, 8 bar Regulator + Gauge and Wall Mounting Brackets**

Port size	Flow dm ³ /s (scfm)	Manual Drain	Weight	Auto Drain	Weight
1/4"	20 42	P32CB12GEMNGLNW	1.29 kg (2.84 lbs)	P32CB12GEANGLNW	1.29 kg (2.84 lbs)
3/8"	32 68	P32CB13GEMNGLNW	1.29 kg (2.84 lbs)	P32CB13GEANGLNW	1.29 kg (2.84 lbs)
1/2"	40 85	P32CB14GEMNGLNW	1.29 kg (2.84 lbs)	P32CB14GEANGLNW	1.29 kg (2.84 lbs)

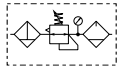

**Filter/Regulator + Lubricator Combinations + Poly bowl
5 micron element, 8 bar Regulator + Gauge and Wall Mounting Brackets**

Port size	Flow dm ³ /s (scfm)	Manual Drain	Weight	Auto Drain	Weight
1/4"	22 45	P32CA12GEMNGLNW	1.03 kg (2.27 lbs)	P32CA12GEANGLNW	1.03 kg (2.27 lbs)
3/8"	33 70	P32CA13GEMNGLNW	1.03 kg (2.27 lbs)	P32CA13GEANGLNW	1.03 kg (2.27 lbs)
1/2"	43 90	P32CA14GEMNGLNW	1.03 kg (2.27 lbs)	P32CA14GEANGLNW	1.03 kg (2.27 lbs)

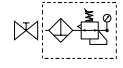

**Slide Valve + Filter/Regulator + Lubricator Combinations + Poly bowl
5 micron element, 8 bar Regulator + Gauge and Wall Mounting Brackets**

Port size	Flow dm ³ /s (scfm)	Manual Drain	Weight	Auto Drain	Weight
1/4"	22 45	P32YA12GEMNGLNW	1.5 kg (3.3 lbs)	P32YA12GEANGLNW	1.5 kg (3.3 lbs)
3/8"	33 70	P32YA13GEMNGLNW	1.5 kg (3.3 lbs)	P32YA13GEANGLNW	1.5 kg (3.3 lbs)
1/2"	43 90	P32YA14GEMNGLNW	1.5 kg (3.3 lbs)	P32YA14GEANGLNW	1.5 kg (3.3 lbs)

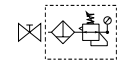

**Slide Valve + Filter/Regulator Combinations + Poly bowl
5 micron element, 8 bar Regulator + Gauge and Wall Mounting Brackets**

Port size	Flow dm ³ /s (scfm)	Manual Drain	Weight	Auto Drain	Weight
1/4"	22 45	P32YN12GEMNGW	1.1 kg (2.42 lbs)	P32YN12GEANGW	1.1 kg (2.42 lbs)
3/8"	33 70	P32YN13GEMNGW	1.1 kg (2.42 lbs)	P32YN13GEANGW	1.1 kg (2.42 lbs)
1/2"	43 90	P32YN14GEMNGW	1.1 kg (2.42 lbs)	P32YN14GEANGW	1.1 kg (2.42 lbs)

P 3 2 **E** **N** **L N** **W**

Combination		Thread type		Port size		Drain type		Adjustment range		Add only for options with Lubricator
Combination	C	BSPP	1	1/4	2	Auto drain	A	With round gauge		
Shut off + Combination ¹	Y	NPT	9	3/8	3	Manual drain	M	0-2 bar; 0-30 psi; 0.2 MPa	Z	
				1/2	4			4 bar; 60 psi; 0.4 MPa	M	
								8 bar; 125 psi; 0.8 MPa	G	

¹ Option not available with F+R+L

Combination type		Bowl type	
F/R+L	A	Poly bowl with bowl guard	G
F+R+L	B	Metal bowl with sight glass	S
F/R	N		

Note: All bowl types are the same for each component
Example: If a "G" is specified for a F+L, both units would get a poly bowl with bowl guard.

Popular Combinations : Inlet pressure 10 bar, Secondary pressure 6.3 bar, 1 bar pressure drop.

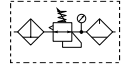

**Filter + Regulator + Lubricator Combinations + Poly bowl
5 micron element, 8 bar Regulator + Gauge and Wall Mounting Brackets**

Port size	Flow dm³/s	Flow (scfm)	Manual Drain	Weight	Auto Drain	Weight
1/2"	43	90	P33CB14GEMNGLNW	1.84 kg (4.06 lbs)	P33CB14GEANGLNW	1.84 kg (4.06 lbs)
3/4"	52	110	P33CB16GEMNGLNW	1.84 kg (4.06 lbs)	P33CB16GEANGLNW	1.84 kg (4.06 lbs)

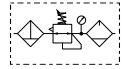

**Filter/Regulator + Lubricator Combinations + Poly bowl
5 micron element, 8 bar Regulator + Gauge and Wall Mounting Brackets**

Port size	Flow dm³/s	Flow (scfm)	Manual Drain	Weight	Auto Drain	Weight
1/2"	52	110	P33CA14GEMNGLNW	1.51 kg (3.33 lbs)	P33CA14GEANGLNW	1.51 kg (3.33 lbs)
3/4"	71	150	P33CA16GEMNGLNW	1.51 kg (3.33 lbs)	P33CA16GEANGLNW	1.51 kg (3.33 lbs)

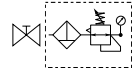

**Slide Valve + Filter/Regulator + Lubricator Combinations + Poly bowl
5 micron element, 8 bar Regulator + Gauge and Wall Mounting Brackets**

Port size	Flow dm³/s	Flow (scfm)	Manual Drain	Weight	Auto Drain	Weight
1/2"	52	110	P33YA14GEMNGLNW	2.35 kg (5.2 lbs)	P33YA14GEANGLNW	2.35 kg (5.2 lbs)
3/4"	71	150	P33YA16GEMNGLNW	2.35 kg (5.2 lbs)	P33YA16GEANGLNW	2.35 kg (5.2 lbs)

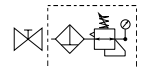

**Slide Valve + Filter/Regulator Combinations + Poly bowl
5 micron element, 8 bar Regulator + Gauge and Wall Mounting Brackets**

Port size	Flow dm³/s	Flow (scfm)	Manual Drain	Weight	Auto Drain	Weight
1/2"	52	110	P33YN14GEMNGW	1.7 kg (3.75 lbs)	P33YN14GEANGW	1.7 kg (3.75 lbs)
3/4"	71	150	P33YN16GEMNGW	1.7 kg (3.75 lbs)	P33YN16GEANGW	1.7 kg (3.75 lbs)

P 33 **E** **N** **L N** **W**

Combination	Thread type	Port size	Drain type	Adjustment range	Add only for options with Lubricator
Combination C	BSPP 1	1/2 4	Auto drain A	With round gauge	
Shut off + Combination ¹ Y	NPT 9	3/4 6	Manual drain M	0-2 bar; 0-30 psi; 0.2 MPa Z	
				4 bar; 60 psi; 0.4 MPa M	
				8 bar; 125 psi; 0.8 MPa G	

¹ Option not available with F+R+L.

Combination type	Bowl type
F/R+L A	Poly bowl with bowl guard G
F+R+L B	Metal bowl with sight glass S
F/R N	

Note: All bowl types are the same for each component
Example: If a "G" is specified for a F+L, both units would get a poly bowl with bowl guard.

Popular Combination Dimensions - mm (inches)

P31

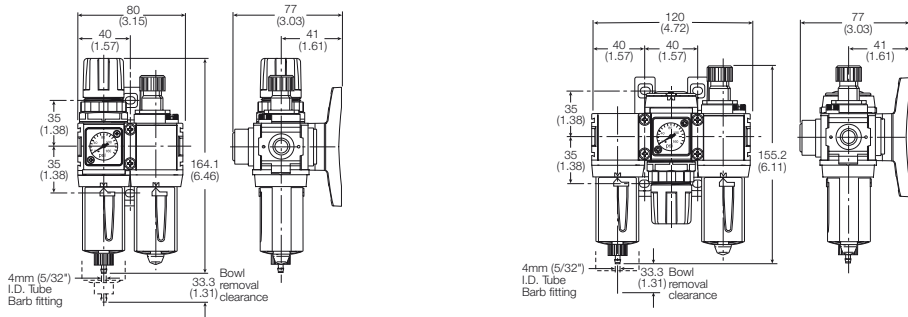

P32

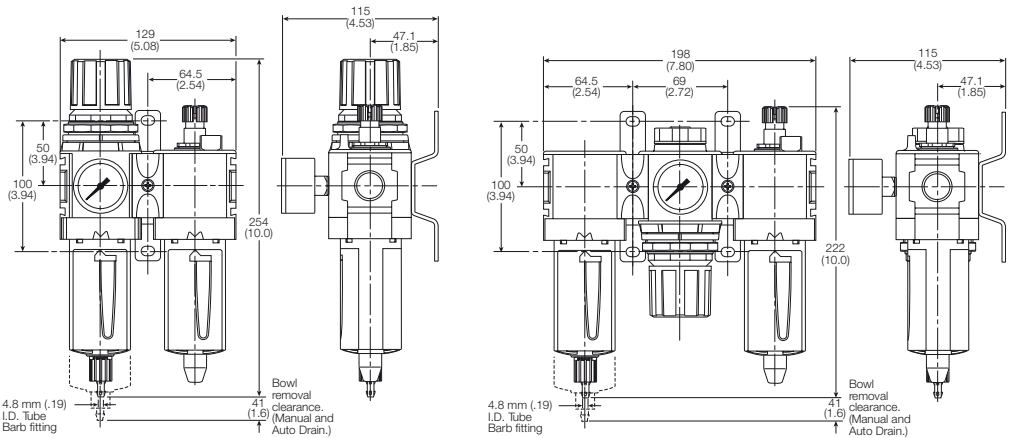

P33

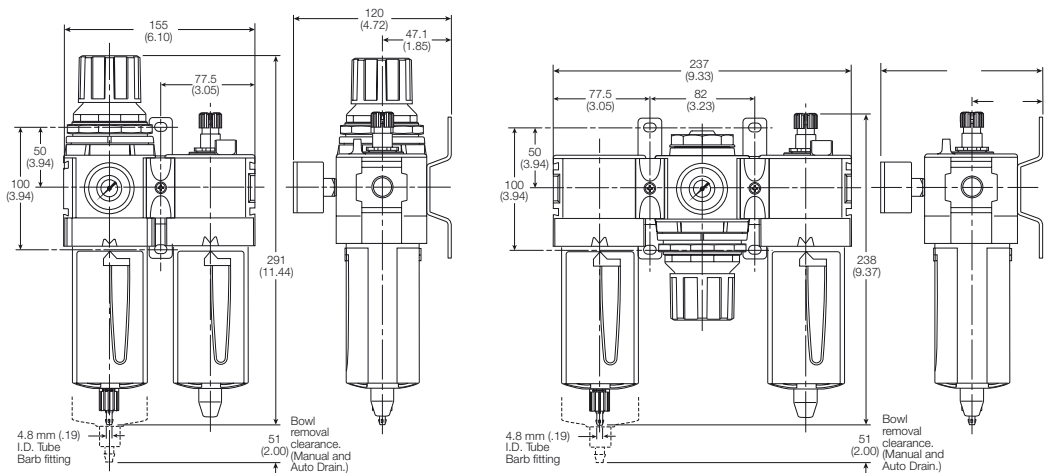

Mini Particulate Filter P31



Symbols

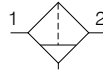

Manual drain

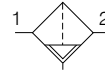

Pulse drain

- Integral 1/4 ports (BSP & NPT)
- High efficiency 5 micron element as standard
- Excellent water removal efficiency
- Robust but lightweight aluminium construction
- One hand operation for easy element cartridge removal
- Positive bayonet latch to ensure correct & safe fitting

Options:

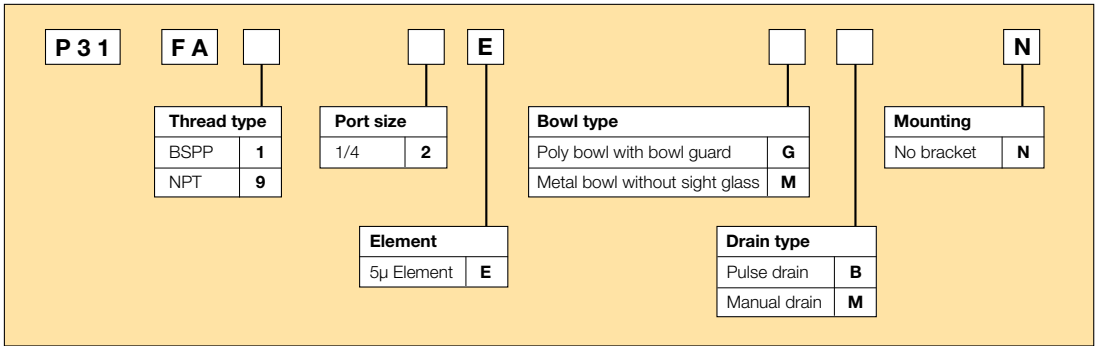

Port size	Description	Order Code	Flow dm ³ /s (scfm) *	Max bar (psi) *	Height mm (Inches)	Width mm (Inches)	Depth mm (Inches)
1/4"	Poly bowl - Manual drain	P31FA12EGMN	12 (25)	10 (150)	116.3 (4.58)	40 (1.58)	42.7 (1.68)
1/4"	Poly bowl - Pulse drain	P31FA12EGBN	12 (25)	10 (150)	116.3 (4.58)	40 (1.58)	42.7 (1.68)
1/4"	Metal bowl - Manual drain	P31FA12EMMN	12 (25)	17 (250)	116.3 (4.58)	40 (1.58)	42.7 (1.68)
1/4"	Metal bowl - Pulse drain	P31FA12EMBN	12 (25)	17 (250)	116.3 (4.58)	40 (1.58)	42.7 (1.68)

* flow with 6.3 bar (91.3 psig) inlet pressure and 0.34 (4.9 psig) pressure drop.

Specifications

Flow Capacity	1/4	12 dm ³ /s (25 scfm)
Operating Temperature	Plastic Bowl	-10°C (14°F) to 52°C (125°F)
	Metal Bowl	-10°C (14°F) to 65.5°C (150°F)
Max Supply Pressure	Plastic Bowl	10 bar (150 psi)
	Metal Bowl	17 bar (250 psi)
Standard Filtration		5 Micron
Useful Retention		12 cm ³ (0.4 US oz.)
Port Size	BSPP / NPT	1/4
Weight		0.11 kg (0.24 lbs)

* Inlet pressure 6.3 bar (91.3 psig). Pressure drop 0.34 bar (4.9 psig).

Air quality:

Within ISO 8573-1: 1991 Class 3 (Particulates)
Within ISO 8573-1: 2001 Class 6 (Particulates)

Materials of Construction

Body	Aluminium
Body Cap	ABS
Bowl	Polycarbonate
Bowl Guard	Nylon
Element Retainer	Acetal
Baffle	Acetal
Filter Element	Sintered Polyethylene
Seals	Nitrile

Flow Charts

1/4 Filter

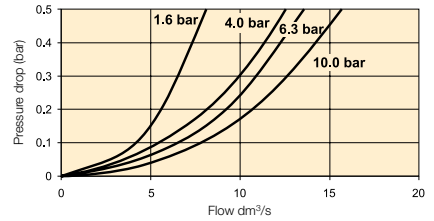

Dimensions

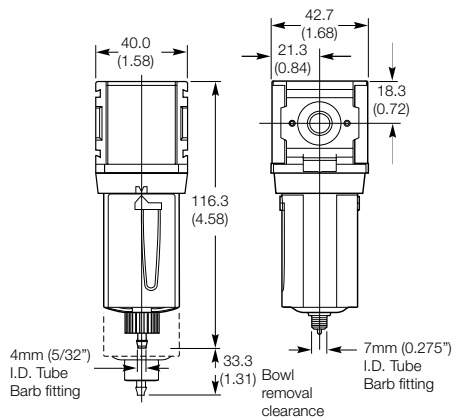

Repair and Service Kits

Plastic bowl / Bowl guard manual drain	P31KA00BGM
Metal bowl / w/o sight gauge manual drain	P31KA00BMM
Plastic bowl / Bowl guard pulse drain	P31KA00BGB
Metal bowl / w/o sight gauge pulse drain	P31KA00BMB
5µ particle filter element	P31KA00ESE
C-Bracket (fits to body)	P31KA00MW
T-Bracket with body connector	P31KA00MT
Body connector	P31KA00CB

Compact Particulate Filter P32



Symbols

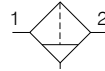

Manual drain

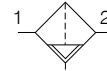

Auto drain

- Integral 1/4, 3/8 or 1/2 ports (BSPP & NPT)
- High efficiency 5 micron element as standard
- Excellent water removal efficiency
- Robust but lightweight aluminium construction
- Positive bayonet latch to ensure correct & safe fitting

Options:

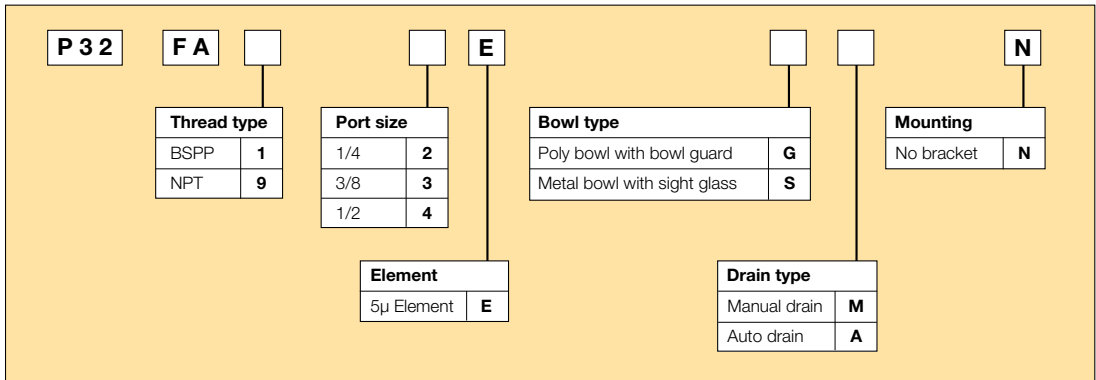

Port size	Description	Order Code	Flow dm ³ /s (scfm)	Max bar (psi)	Height mm (Inches)	Width mm (Inches)	Depth mm (Inches)
1/4	Poly bowl - Manual drain	P32FA12EGMN	18 (38)	10 (150)	188 (7.4)	60 (2.36)	60 (2.36)
1/4	Poly bowl - Auto drain	P32FA12EGAN	18 (38)	10 (150)	182 (7.2)	60 (2.36)	60 (2.36)
1/4	Metal bowl sight glass - Manual drain	P32FA12ESMN	18 (38)	17 (250)	188 (7.4)	60 (2.36)	60 (2.36)
1/4	Metal bowl sight glass - Auto drain	P32FA12ESAN	18 (38)	17 (250)	182 (7.2)	60 (2.36)	60 (2.36)
3/8	Poly bowl - Manual drain	P32FA13EGMN	30 (64)	10 (150)	188 (7.4)	60 (2.36)	60 (2.36)
3/8	Poly bowl - Auto drain	P32FA13EGAN	30 (64)	10 (150)	182 (7.2)	60 (2.36)	60 (2.36)
3/8	Metal bowl sight glass - Manual drain	P32FA13ESMN	30 (64)	17 (250)	188 (7.4)	60 (2.36)	60 (2.36)
3/8	Metal bowl sight glass - Auto drain	P32FA13ESAN	30 (64)	17 (250)	182 (7.2)	60 (2.36)	60 (2.36)
1/2	Poly bowl - Manual drain	P32FA14EGMN	38 (80)	10 (150)	188 (7.4)	60 (2.36)	60 (2.36)
1/2	Poly bowl - Auto drain	P32FA14EGAN	38 (80)	10 (150)	182 (7.2)	60 (2.36)	60 (2.36)
1/2	Metal bowl sight glass - Manual drain	P32FA14ESMN	38 (80)	17 (250)	188 (7.4)	60 (2.36)	60 (2.36)
1/2	Metal bowl sight glass - Auto drain	P32FA14ESAN	38 (80)	17 (250)	182 (7.2)	60 (2.36)	60 (2.36)

* flow with 6.3 bar (91.3 psig) inlet pressure and 0.34 (4.9 psig) pressure drop.

Specifications

Flow Capacity*	1/4	18 dm ³ /s (38 scfm)
	3/8	30 dm ³ /s (64 scfm)
	1/2	38 dm ³ /s (80 scfm)
Operating Temperature	Plastic Bowl	-25°C (-13°F) to 52°C (125°F)
	Metal Bowl	-25°C (-13°F) to 65.5°C (150°F)
Max Supply Pressure	Plastic Bowl	10 bar (150 psi)
	Metal Bowl	17 bar (250 psi)
Standard Filtration		5 Micron
Useful Retention**		51 cm ³ (1.7 US oz.)
Port Size	BSP / NPT	1/4, 3/8, 1/2
Weight		0.28 kg (0.62 lbs)

* Inlet pressure 6.3 bar (91.3 psig). Pressure drop 0.34 bar (4.9 psig).
** Useful retention refers to volume below the quiet zone baffle.

Air quality:

Within ISO 8573-1: 1991 Class 3 (Particulates)
Within ISO 8573-1: 2001 Class 6 (Particulates)

Materials of Construction

Body	Aluminium	
Body Cap	ABS	
Bowls	Plastic Bowl	Polycarbonate
	Metal Bowl	Aluminium
Bowl Guard	Nylon	
Deflector	Polypropylene	
Element Retainer / Baffle	Acetal	
Filter Element	Sintered Polyethylene	
Seals	Plastic Bowl	Nitrile
	Metal Bowl	Nitrile
Sight Gauge	Metal Bowl	Polycarbonate

Dimensions

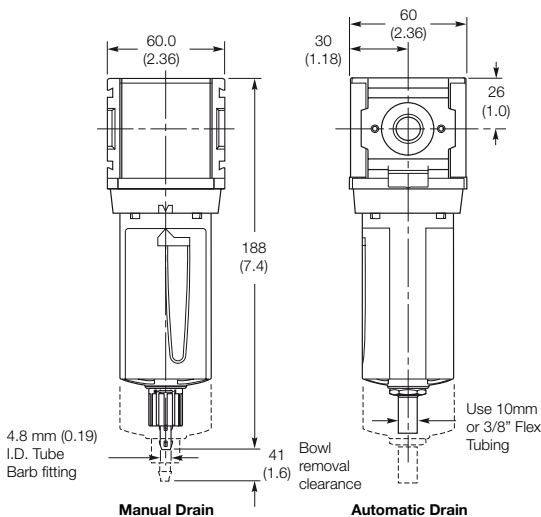

Flow Charts

1/4 Filter

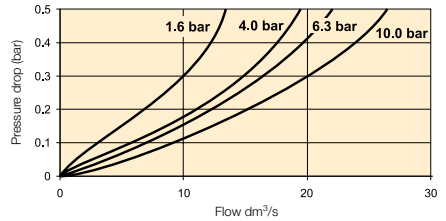

3/8 Filter

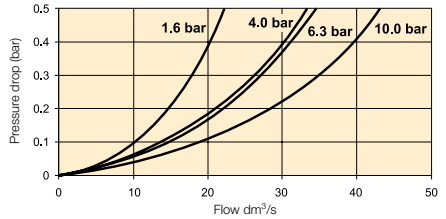

1/2 Filter

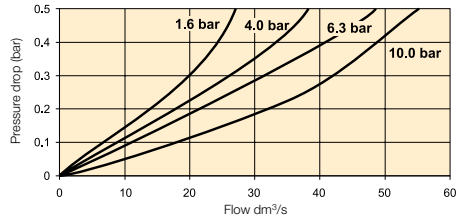

Repair and Service Kits

Plastic bowl / Bowl guard manual drain	P32KA00BGM
Metal bowl / Sight gauge manual drain	P32KA00BSM
Auto drain	P32KA00DA
5µ particle filter element	P32KA00ESE
L-Bracket (fits to body)	P32KA00ML
T-Bracket (fits to body connector)	P32KA00MB
T-Bracket with body connector	P32KA00MT
Body connector	P32KA00CB

Standard Particulate Filter P33



Symbols

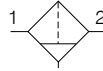

Manual drain

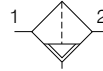

Auto drain

- Integral 1/2 or 3/4 ports (BSPP & NPT)
- High efficiency 5 micron element as standard
- Excellent water removal efficiency
- Robust but lightweight aluminium construction
- Positive bayonet latch to ensure correct & safe fitting

Options:

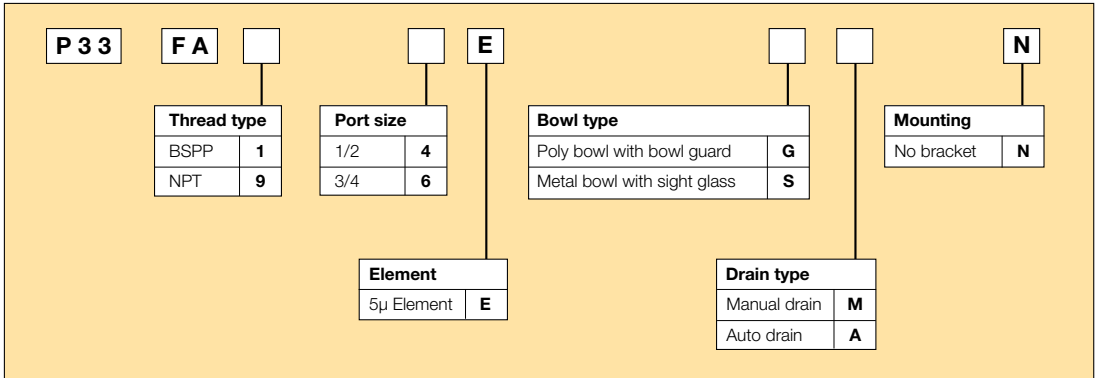

Port size	Description	Order Code	Flow dm ³ /s (scfm)	Max bar (psi)	Height mm (Inches)	Width mm (Inches)	Depth mm (Inches)
1/2"	Poly bowl - Manual drain	P33FA14EGMN	40 (85)	10 (150)	213 (8.4)	73 (2.9)	73 (2.9)
1/2"	Poly bowl - Auto drain	P33FA14EGAN	40 (85)	10 (150)	207 (8.2)	73 (2.9)	73 (2.9)
1/2"	Metal bowl sight glass - Manual drain	P33FA14ESMN	40 (85)	17 (250)	213 (8.4)	73 (2.9)	73 (2.9)
1/2"	Metal bowl sight glass - Auto drain	P33FA14ESAN	40 (85)	17 (250)	207 (8.2)	73 (2.9)	73 (2.9)
3/4"	Poly bowl - Manual drain	P33FA16EGMN	48 (102)	10 (150)	213 (8.4)	73 (2.9)	73 (2.9)
3/4"	Poly bowl - Auto drain	P33FA16EGAN	48 (102)	10 (150)	207 (8.2)	73 (2.9)	73 (2.9)
3/4"	Metal bowl sight glass - Manual drain	P33FA16ESMN	48 (102)	17 (250)	213 (8.4)	73 (2.9)	73 (2.9)
3/4"	Metal bowl sight glass - Auto drain	P33FA16ESAN	48 (102)	17 (250)	207 (8.2)	73 (2.9)	73 (2.9)

* flow with 6.3 bar (91.3 psig) inlet pressure and 0.34 (4.9 psig) pressure drop.

Specifications

Flow Capacity*	1/2	40 dm ³ /s (85 scfm)
	3/4	48 dm ³ /s (102 scfm)
Operating Temperature	Plastic Bowl	-25°C (-13°F) to 52°C (125°F)
	Metal Bowl	-25°C (-13°F) to 65.5°C (150°F)
Max Supply Pressure	Plastic Bowl	10 bar (150 psi)
	Metal Bowl	17 bar (250 psi)
Standard Filtration		5 Micron
Useful Retention**		85 cm ³ (2.8 US oz.)
Port Size	BSP / NPT	1/2, 3/4
Weight		0.46 kg (1.01 lbs)

* Inlet pressure 6.3 bar (91.3 psig). Pressure drop 0.34 bar (4.9 psig).
** Useful retention refers to volume below the quiet zone baffle.

Air quality:

Within ISO 8573-1: 1991 Class 3 (Particulates)
Within ISO 8573-1: 2001 Class 6 (Particulates)

Materials of Construction

Body	Aluminium	
Body Cap	ABS	
Bowls	Plastic Bowl	Polycarbonate
	Metal Bowl	Aluminium
Bowl Guard	Nylon	
Deflector	Polypropylene	
Element Retainer / Baffle	Acetal	
Filter Element	Sintered Polyethylene	
Seals	Plastic Bowl	Nitrile
	Metal Bowl	Nitrile
Sight Gauge	Metal Bowl	Polycarbonate

Flow Charts

1/2 Filter

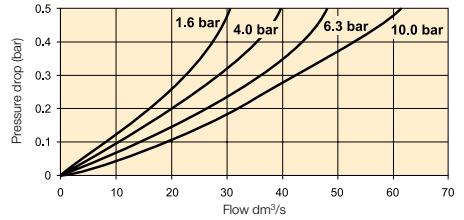

3/4 Filter

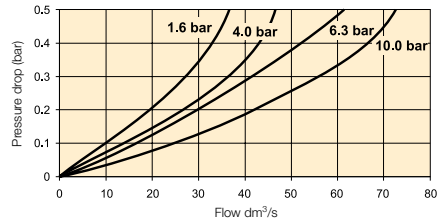

Dimensions

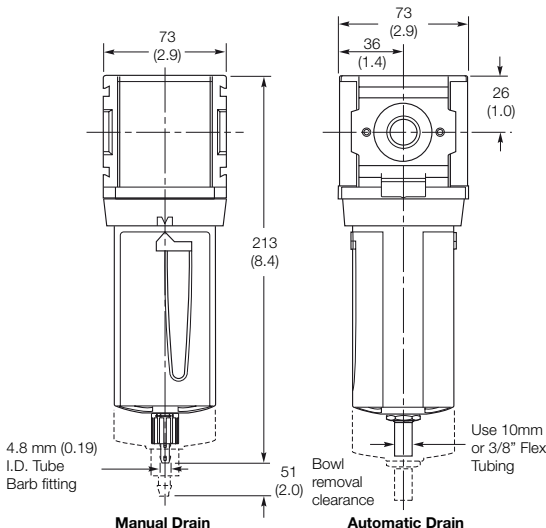

Repair and Service Kits

Plastic bowl / Bowl guard manual drain	P33KA00BGM
Metal bowl / Sight gauge manual drain	P33KA00BSM
Auto drain	P32KA00DA
5µ particle filter element	P33KA00ESE
L-Bracket (fits to body)	P33KA00ML
T-Bracket (fits to body connector)	P32KA00MB
T-Bracket with body connector	P32KA00MT
Body connector	P32KA00CB

Mini Coalescing and Adsorber Filters P31



- Integral 1/4 ports (BSPP & NPT)
- Removes liquid aerosols and sub micron particles
- Oil free air for critical applications, such as air gauging, pneumatic instrumentation and control
- Positive bayonet latch to ensure correct & safe fitting
- Adsorbing activated carbon element removes oil vapours and most hydrocarbons

Note: To optimise the life of coalescing element, it is advisable to install a P31F pre-filter with a 5 micron element upstream of the coalescing filter.

To optimise the life of an Adsorber it is advisable to install a P31 Coalescing Filter upstream of the Adsorber. Adsorber element should be replaced approx. every 1000 hours of service

Options:

P 3 1	FA							N
Thread type		Port size		Bowl type		Mounting		
BSPP	1	1/4	2	Poly bowl with bowl guard	G	No bracket	N	
NPT	9			Metal bowl without sight glass	M			
Element				Drain type				
		0.01µ Element	C	Pulse drain	B			
		1µ Element	9	Manual drain	M			
		Adsorber	A					

Port size	Description	Order Code	Flow dm ³ /s (scfm)	Max bar (psi)	Height mm (Inches)	Width mm (Inches)	Depth mm (Inches)
1/4"	Poly bowl - 0.01 micron - Manual drain	P31FA12CGMN	2 (4.2)	10 (150)	116.3 (4.58)	40 (1.58)	42.7 (1.68)
1/4"	Poly bowl - 0.01 micron - Pulse drain	P31FA12CGBN	2 (4.2)	10 (150)	116.3 (4.58)	40 (1.58)	42.7 (1.68)
1/4"	Metal bowl - 0.01 micron - Manual drain	P31FA12CMMN	2 (4.2)	17 (250)	116.3 (4.58)	40 (1.58)	42.7 (1.68)
1/4"	Metal bowl - 0.01 micron - Pulse drain	P31FA12CMBN	2 (4.2)	17 (250)	116.3 (4.58)	40 (1.58)	42.7 (1.68)
1/4"	Poly bowl - Adsorber	P31FA12AGMN	6 (13)	10 (150)	116.3 (4.58)	40 (1.58)	42.7 (1.68)
1/4"	Metal bowl - Adsorber	P31FA12AMMN	6 (13)	17 (250)	116.3 (4.58)	40 (1.58)	42.7 (1.68)

* flow with 6.3 bar (91.3 psig) inlet pressure and 0.2 bar (3 psig) pressure drop.

Specifications

Flow Capacity		dm ³ /s SCFM
1.0 Micron Coalescing	Energy Efficient Flow*	3.8 (8)
	Maximum Flow**	6 (13)
0.01 Micron Coalescing	Energy Efficient Flow*	2 (4.2)
	Maximum Flow**	3.8 (8)
Activated Carbon Adsorber	Rated Flow*	6 (13)
Operating Temperature	Plastic Bowl	-10°C (14°F) to 52°C (125°F)
	Metal Bowl	-10°C (14°F) to 65.5°C (150°F)
Max Supply Pressure	Plastic Bowl	10 bar (150 psi)
	Metal Bowl	17 bar (250 psi)
Standard Filtration**		1.0 and 0.01 Micron ppm wt

Adsorber	Max oil carryover (ppm w/w)	0.003 @ 21°C (70°F)
Useful Retention		12 cm ³ (0.4 US oz.)
Port Size	BSP / NPT	1/4
Weight		0.11 kg (0.24 lbs)

* Inlet pressure 6.3 bar (90 psi), Pressure drop 0.2 bar (3 psig), Saturated Element.
 ** Inlet pressure 6.3 bar (90 psi), Pressure drop 0.4 bar (6 psig), Saturated Element.
 † Useful retention refers to volume below the quiet zone baffle.

Materials of Construction

Body	Aluminium	
Body Cap	ABS	
Bowl	Plastic Bowl	Polycarbonate
	Metal Bowl	Aluminium
Filter Element	1.0 and .01 Micron	Borosilicate Cloth
Adsorber	Activated Carbon	
Seals	Nitrile	

Dimensions

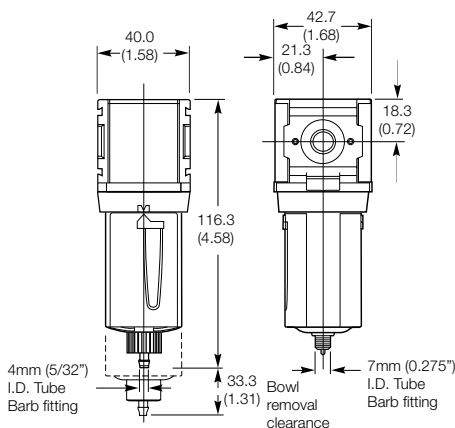

Flow Charts

P31 - 1.0 micron flow

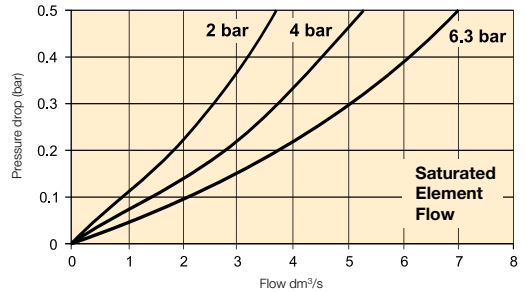

P31 - 0.01 micron flow

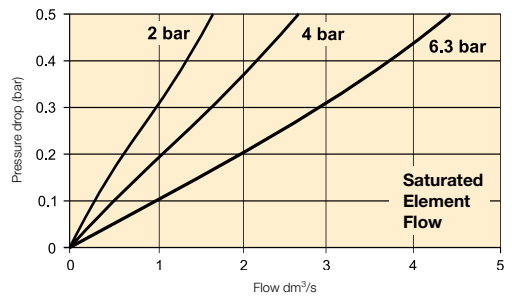

Repair and Service Kits

Plastic bowl / Bowl guard manual drain	P31KA00BGM
Metal bowl / w/o sight gauge manual drain	P31KA00BMM
Plastic bowl / Bowl guard pulse drain	P31KA00BGB
Metal bowl / w/o sight gauge pulse drain	P31KA00BMB
1µ coalescing filter element	P31KA00ES9
0.01µ coalescing filter element	P31KA00ESC
Activated carbon adsorber filter element	P31KA00ESA
C-Bracket (fits to body)	P31KA00MW
T-Bracket with body connector	P31KA00MT
Body connector	P31KA00CB

Compact Coalescing and Adsorber Filter P32



- Integral 1/4, 3/8 or 1/2 ports (BSPP & NPT)
- Removes liquid aerosols and sub micron particles
- Oil free air for critical applications, such as air gauging, pneumatic instrumentation and control
- Differential Pressure Indicator (DPI) standard on Coalescing Filters
- Positive bayonet latch to ensure correct & safe fitting
- Adsorbing activated carbon element removes oil vapours and most hydrocarbons

Note: To optimise the life of coalescing element, it is advisable to install a P32F pre-filter with a 5 micron element upstream of the coalescing filter.

To optimise the life of an Adsorber it is advisable to install a P32 Coalescing Filter upstream of the Adsorber. Adsorber element should be replaced approx. every 1000 hours of service

Options:

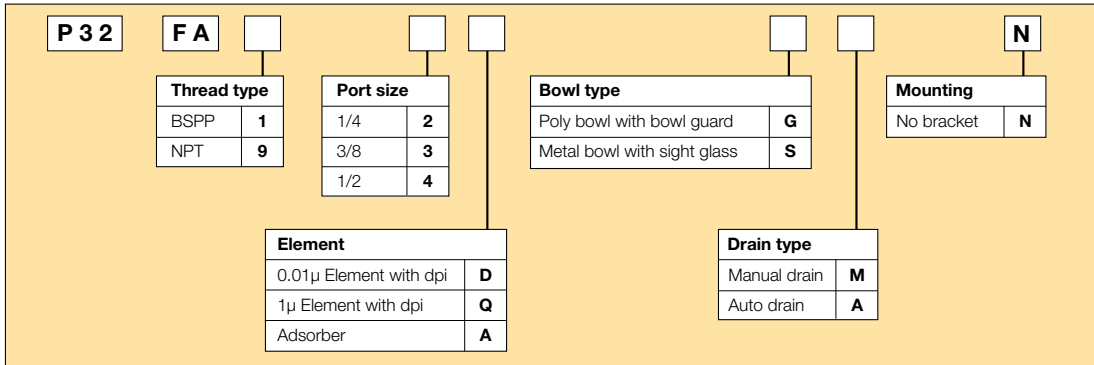

Port size	Description	Order Code	Flow dm ³ /s	(scfm)	Max bar	(psi)	Height mm (Inches)	Width mm (Inches)	Depth mm (Inches)
1/4"	Poly bowl - 0.01 Micron, Manual drain	P32FA12DGMN	11	(23)	10	(150)	209 (8.2)	60 (2.36)	60 (2.36)
1/4"	Poly bowl - 0.01 Micron, Auto drain	P32FA12DGAN	11	(23)	10	(150)	203 (8.0)	60 (2.36)	60 (2.36)
1/4"	Metal bowl sight glass - 0.01 Micron, Manual drain	P32FA12DSMN	11	(23)	17	(250)	209 (8.2)	60 (2.36)	60 (2.36)
1/4"	Metal bowl sight glass - 0.01 Micron, Auto drain	P32FA12DSAN	11	(23)	17	(250)	203 (8.0)	60 (2.36)	60 (2.36)
3/8"	Poly bowl - 0.01 Micron, Manual drain	P32FA13DGMN	11	(23)	10	(150)	209 (8.2)	60 (2.36)	60 (2.36)
3/8"	Poly bowl - 0.01 Micron, Auto drain	P32FA13DGAN	11	(23)	10	(150)	203 (8.0)	60 (2.36)	60 (2.36)
3/8"	Metal bowl sight glass - 0.01 Micron, Manual drain	P32FA13DSMN	11	(23)	17	(250)	209 (8.2)	60 (2.36)	60 (2.36)
3/8"	Metal bowl sight glass - 0.01 Micron, Auto drain	P32FA13DSAN	11	(23)	17	(250)	203 (8.0)	60 (2.36)	60 (2.36)
1/2"	Poly bowl - 0.01 Micron, Manual drain	P32FA14DGMN	11	(23)	10	(150)	209 (8.2)	60 (2.36)	60 (2.36)
1/2"	Poly bowl - 0.01 Micron, Auto drain	P32FA14DGAN	11	(23)	10	(150)	203 (8.0)	60 (2.36)	60 (2.36)
1/2"	Metal bowl sight glass - 0.01 Micron, Manual drain	P32FA14DSMN	11	(23)	17	(250)	209 (8.2)	60 (2.36)	60 (2.36)
1/2"	Metal bowl sight glass - 0.01 Micron, Auto drain	P32FA14DSAN	11	(23)	17	(250)	203 (8.0)	60 (2.36)	60 (2.36)
1/4"	Poly bowl - Adsorber	P32FA12AGMN	27	(57)	10	(150)	209 (8.2)	60 (2.36)	60 (2.36)
1/4"	Metal bowl sight glass - Adsorber	P32FA12ASMN	27	(57)	17	(250)	209 (8.2)	60 (2.36)	60 (2.36)
3/8"	Poly bowl - Adsorber	P32FA13AGMN	27	(57)	10	(150)	209 (8.2)	60 (2.36)	60 (2.36)
3/8"	Metal bowl sight glass - Adsorber	P32FA13ASMN	27	(57)	17	(250)	209 (8.2)	60 (2.36)	60 (2.36)
1/2"	Poly bowl - Adsorber	P32FA14AGMN	27	(57)	10	(150)	209 (8.2)	60 (2.36)	60 (2.36)
1/2"	Metal bowl sight glass - Adsorber	P32FA14ASMN	27	(57)	17	(250)	209 (8.2)	60 (2.36)	60 (2.36)

* flow with 6.3 bar (91.3 psig) inlet pressure and 0.2 bar (3 psig) pressure drop.

Specifications

Flow Capacity		dm ³ /s	SCFM
1.0 Micron Coalescing Energy Efficient Flow*		17	(36)
Maximum Flow**		27	(57)
0.01 Micron Coalescing Energy Efficient Flow*		11	(23)
Maximum Flow**		18	(38)
Activated Carbon Adsorber Rated Flow*		27	(57)
Operating Temperature	Plastic Bowl	-25°C (-13°F) to 52°C (125°F)	
	Metal Bowl	-25°C (-13°F) to 65.5°C (150°F)	
Max Supply Pressure**	Plastic Bowl	10 bar (150 psi)	
	Metal Bowl	17 bar (250 psi)	
Standard Filtration†		1.0 and 0.01 Micron ppm wt	
Adsorber Max oil carryover (ppm w/w)		0.003 @ 21°C (70°F)	
Useful Retention†		51 cm ³ (1.7 US oz.)	
Port Size	BSP / NPT	1/4, 3/8, 1/2	
Weight		0.32 kg (0.71 lbs)	

* Inlet pressure 6.3 bar (90 psi), Pressure drop 0.2 bar (3 psig), Saturated Element.
 ** Inlet pressure 6.3 bar (90 psi), Pressure drop 0.4 bar (6 psig), Saturated Element.
 † Useful retention refers to volume below the quiet zone baffle.

Flow Charts

P32 - 1.0 micron flow

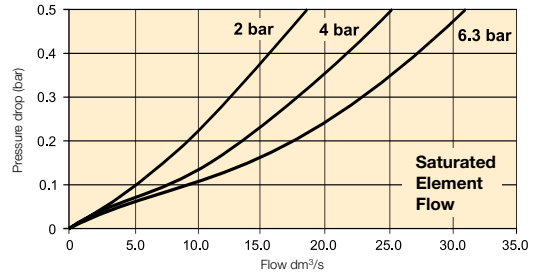

P32 - 0.01 micron flow

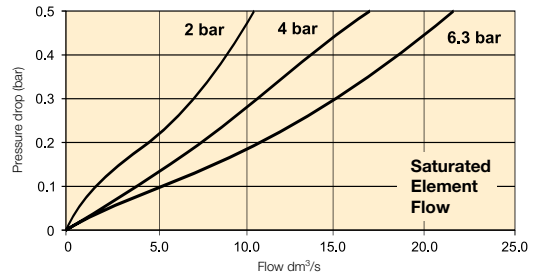

Dimensions

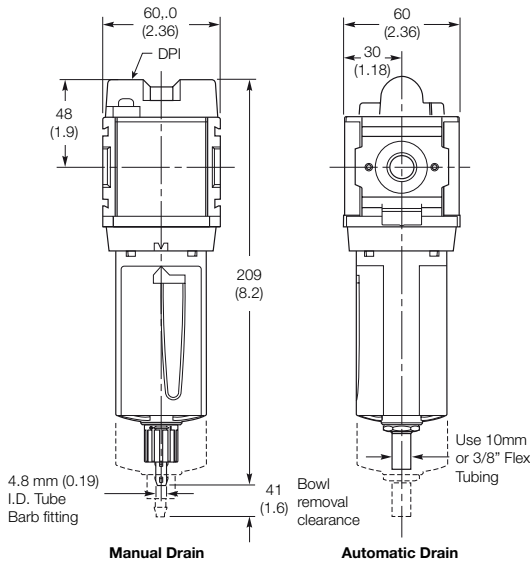

Materials of Construction

Body	Aluminium	
Body Cap	ABS	
Bowls	Plastic Bowl	Polycarbonate
	Metal Bowl	Aluminium
Filter Element	1.0 and .01 Micron	Borosilicate Cloth
Adsorber	Activated Carbon	
Seals	Nitrile	
Sight Gauge	Metal Bowl	Polycarbonate

Repair and Service Kits

Plastic bowl / Bowl guard manual drain	P32KA00BGM
Metal bowl / Sight gauge manual drain	P32KA00BSM
Auto drain	P32KA00DA
1µ coalescing filter element	P32KA00ES9
0.01µ coalescing filter element	P32KA00ESC
Activated carbon adsorber filter element	P32KA00ESA
L-Bracket (fits to body)	P32KA00ML
T-Bracket (fits to body connector)	P32KA00MB
T-Bracket with body connector	P32KA00MT
Body connector	P32KA00CB
Differential pressure indicator (replacement)	P32KA00RQ

Standard Coalescing and Adsorber Filter P33



- Integral 1/2 or 3/4 ports (BSPP & NPT)
- Removes liquid aerosols and sub micron particles
- Oil free air for critical applications, such as air gauging, pneumatic instrumentation and control
- Differential Pressure Indicator (DPI) standard on Coalescing Filters
- Positive bayonet latch to ensure correct & safe fitting
- Adsorbing activated carbon element removes oil vapours and most hydrocarbons

Note: To optimise the life of coalescing element, it is advisable to install a P33F pre-filter with a 5 micron element upstream of the coalescing filter.

To optimise the life of an Adsorber it is advisable to install a P33 Coalescing Filter upstream of the Adsorber. Adsorber element should be replaced approx. every 1000 hours of service

Options:

P 3 3	F A							N
Thread type		Port size		Bowl type		Mounting		
BSPP	1	1/2	4	Poly bowl with bowl guard	G	No bracket		N
NPT	9	3/4	6	Metal bowl with sight glass	S			
Element				Drain type				
0.01µ Element with dpi		D		Manual drain		M		
1µ Element with dpi		Q		Auto drain		A		
Adsorber		A						

Port size	Description	Order Code	Flow dm ³ /s (scfm)	Max bar (psi)	Height mm (Inches)	Width mm (Inches)	Depth mm (Inches)
1/2"	Poly bowl - 0.01 Micron, Manual drain	P33FA14DGMN	20 (42)	10 (150)	235 (9.3)	73 (2.9)	73 (2.9)
1/2"	Poly bowl - 0.01 Micron, Auto drain	P33FA14DGAN	20 (42)	10 (150)	229 (9.0)	73 (2.9)	73 (2.9)
1/2"	Metal bowl sight glass - 0.01 Micron, Manual drain	P33FA14DSMN	20 (42)	17 (250)	235 (9.3)	73 (2.9)	73 (2.9)
1/2"	Metal bowl sight glass - 0.01 Micron, Auto drain	P33FA14DSAN	20 (42)	17 (250)	229 (9.0)	73 (2.9)	73 (2.9)
3/4"	Poly bowl - 0.01 Micron, Manual drain	P33FA16DGMN	20 (42)	10 (150)	235 (9.3)	73 (2.9)	73 (2.9)
3/4"	Poly bowl - 0.01 Micron, Auto drain	P33FA16DGAN	20 (42)	10 (150)	229 (9.0)	73 (2.9)	73 (2.9)
3/4"	Metal bowl sight glass - 0.01 Micron, Manual drain	P33FA16DSMN	20 (42)	17 (250)	235 (9.3)	73 (2.9)	73 (2.9)
3/4"	Metal bowl sight glass - 0.01 Micron, Auto drain	P33FA16DSAN	20 (42)	17 (250)	229 (9.0)	73 (2.9)	73 (2.9)
1/2"	Poly bowl - Adsorber	P33FA14AGMN	44 (93)	10 (150)	253 (9.3)	73 (2.9)	73 (2.9)
1/2"	Metal bowl sight glass - Adsorber	P33FA14ASMN	44 (93)	17 (250)	253 (9.3)	73 (2.9)	73 (2.9)
3/4"	Poly bowl - Adsorber	P33FA16AGMN	44 (93)	10 (150)	253 (9.3)	73 (2.9)	73 (2.9)
3/4"	Metal bowl sight glass - Adsorber	P33FA16ASMN	44 (93)	17 (250)	253 (9.3)	73 (2.9)	73 (2.9)

* flow with 6.3 bar (91.3 psig) inlet pressure and 0.2 bar (3 psig) pressure drop.

Specifications

Flow Capacity		dm ³ /s	SCFM
1.0 Micron Coalescing	Energy Efficient Flow*	32	(68)
Maximum Flow**		44	(93)
0.01 Micron Coalescing	Energy Efficient Flow*	20	(42)
	Maximum Flow**	34	(72)
Activated Carbon Adsorber	Rated Flow*	44	(93)
Operating Temperature	Plastic Bowl	-25°C (-13°F) to 52°C (125°F)	
	Metal Bowl	-25°C (-13°F) to 65.5°C (150°F)	
Max Supply Pressure**	Plastic Bowl	10 bar (150 psi)	
	Metal Bowl	17 bar (250 psi)	
Standard Filtration†		1.0 and 0.01 Micron ppm wt	
Adsorber	Max oil carryover (ppm w/w)	0.003 @ 21°C (70°F)	
Useful Retention†		85 cm ³ (2.8 US oz.)	
Port Size	BSPP / NPT	1/2, 3/4	
Weight		0.50 kg (1.10 lbs)	

* Inlet pressure 6.3 bar (90 psi), Pressure drop 0.2 bar (3 psig), Saturated Element.

** Inlet pressure 6.3 bar (90 psi), Pressure drop 0.4 bar (6 psig), Saturated Element.

† Useful retention refers to volume below the quiet zone baffle.

Flow Charts

P33 - 1.0 micron flow

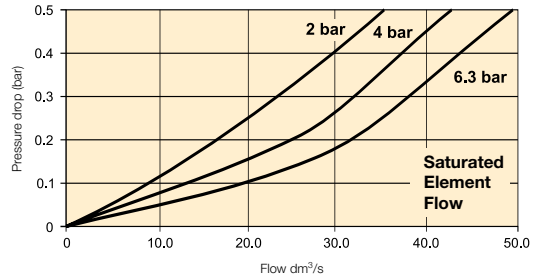

P33 - 0.01 micron flow

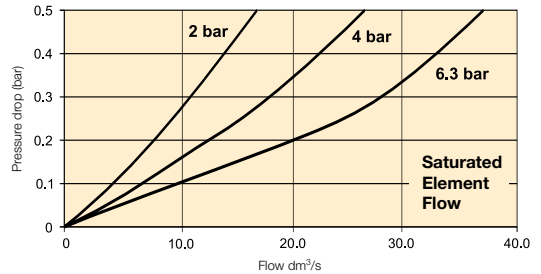

Dimensions

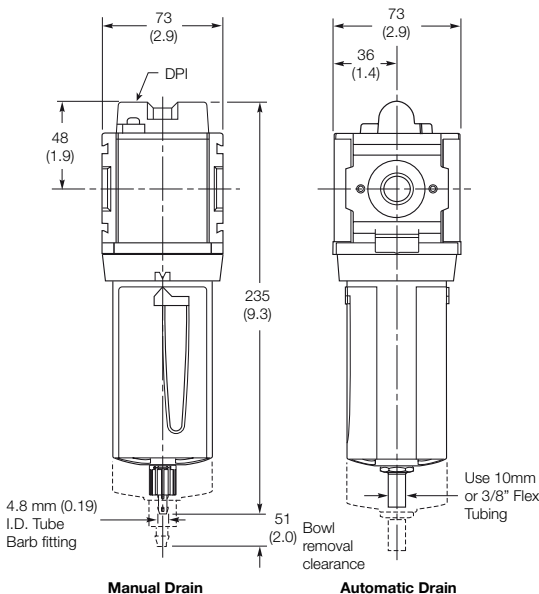

Materials of Construction

Body	Aluminium	
Body Cap	ABS	
Bowls	Plastic Bowl	Polycarbonate
	Metal Bowl	Zinc
Filter Element	1.0 and .01 Micron	Borosilicate Cloth
Adsorber	Activated Carbon	
Seals	Nitrile	
Sight Gauge	Metal Bowl	Polycarbonate

Repair and Service Kits

Plastic bowl / Bowl guard manual drain	P33KA00BGM
Metal bowl / Sight gauge manual drain	P33KA00BSM
Auto drain	P32KA00DA
1µ coalescing filter element	P33KA00ES9
0.01µ coalescing filter element	P33KA00ESC
Activated carbon adsorber filter element	P33KA00ESA
L-Bracket (fits to body)	P33KA00ML
T-Bracket (fits to body connector)	P32KA00MB
T-Bracket with body connector	P32KA00MT
Body connector	P32KA00CB
Differential pressure indicator (replacement)	P32KA00RQ

Mini Regulator P31



Symbols

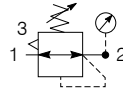

Self relieving regulator with gauge

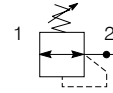

Non relieving regulator

- Integral 1/4 ports (BSPP & NPT)
- Robust but lightweight aluminium construction
- Secondary pressure ranges 2, 4 & 8 bar
- Secondary aspiration plus balanced poppet provides quick response and accurate pressure regulation.
- Relieving & Non-relieving types
- Non-rising knob

Options:

P 3 1	R A			N		P	
Thread type		Port size		Mounting			
BSPP	1	1/4	2	Plastic panel mount nut P			
NPT	9						
Relief				Adjustment range			
Relieving B				With square gauge			
Non relieving N				Without gauge			
				2 bar *	V	2 bar	Y
				4 bar	S	4 bar	L
				8 bar **	T	8 bar	N

* Unit comes with 0-4 bar gauge
** Unit comes with 0-10 bar gauge

Port size	Description	Order Code	Flow dm ³ /s (scfm)	Max bar (psi)	Height mm (Inches)	Width mm (Inches)	Depth mm (Inches)
1/4"	8 bar relieving	P31RA12BNNP	30 (64)	20 (300)	100.1 (3.94)	40 (1.58)	40 (1.58)
1/4"	8 bar relieving + gauge	P31RA12BNTP	30 (64)	20 (300)	100.1 (3.94)	40 (1.58)	64.3 (2.53)

* flow with 6.3 bar (91.3 psig) inlet pressure and 0.34 (4.9 psig) pressure drop.

Specifications

Flow Capacity*	1/4	30 dm ³ /s (64 scfm)
Operating Temperature	-20°C (-4°F) to 65.5°C (150°F)	
Max Supply Pressure	20 bar (300 psi)	
Adjusting Range Pressure	0-2 bar (30 psi)	
	0-4 bar (60 psi)	
	0-8 bar (125 psi)	
Port Size	BSPP / NPT	1/4
Gauge Port (2 ea.)**	BSPP / NPT	1/8
Weight	0.17 kg (0.37 lbs)	

* Inlet pressure 10 bar. Secondary pressure 6.3 bar.
** Non-gauge option only.

Materials of Construction

Body	Aluminium
Adjustment Knob	Acetal
Body Cap	ABS
Bonnet	PBT
Diaphragm Assembly	Brass / Nitrile
Bottom Plug	33% Glass-Filled Nylon
Valve Assembly	Brass / Nitrile
Springs	Steel
Seals	Nitrile
Panel Nut	Acetal

Dimensions

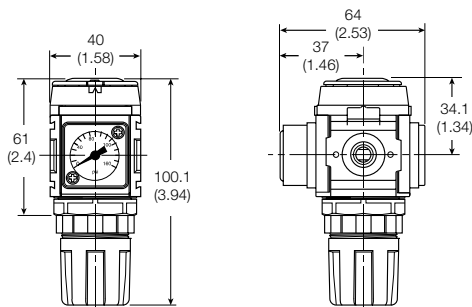

NOTE: 31.7 mm hole required for panel nut mounting.

⚠ WARNING

**Product rupture can cause serious injury.
Do not connect regulator to bottled gas.
Do not exceed maximum primary pressure rating.**

CAUTION:

REGULATOR PRESSURE ADJUSTMENT – The working range of knob adjustment is designed to permit outlet pressures within their full range. Pressure adjustment beyond this range is also possible because the knob is not a limiting device. This is a common characteristic of most industrial regulators, and limiting devices may be obtained only by special design. For best performance, regulated pressure should always be set by increasing the pressure up to the desired setting.

Flow Charts

1/4 Regulator

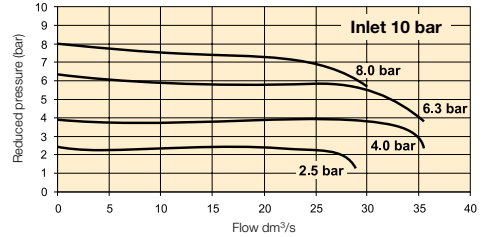

Repair and Service Kits

Regulator repair kit - Relieving	P31KA00RB
Regulator repair kit - Non-relieving	P31KA00RC
Panel mount nut - Aluminium	P31KA00MM
Panel mount nut - Plastic	P31KA00MP
Angle Bracket (uses panel mount threads)	P31KA00MR
C-Bracket (fits to body)	P31KA00MW
T-Bracket with body connector	P31KA00MT
Body connector	P31KA00CB

Gauges

Square flush mount gauge

replacement for unit ordered with square gauge

0-4 bar	K4511SCR04B
0-10 bar	K4511SCR11B

40mm (1 1/2") Round 1/8" center back mount

for units ordered without square gauge

0-30 PSIG / 0-2 bar	P3D-KAB1AYN
0-58 PSIG / 0-4 bar	P3D-KAB1ALN
0-160 PSIG / 0-10 bar	P3D-KAB1ANN

Mini Common - P1 Regulator P31

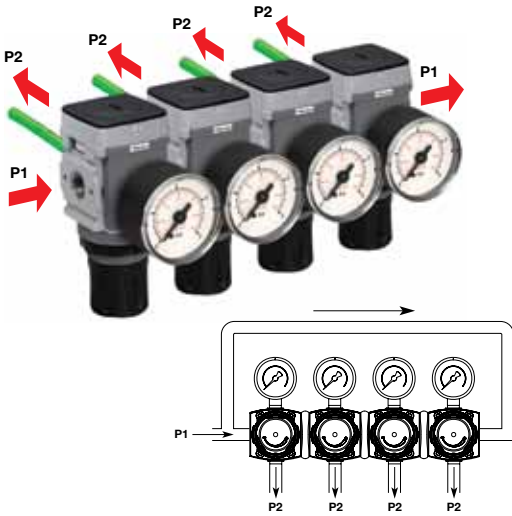

Symbols

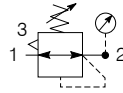

Self relieving regulator with gauge

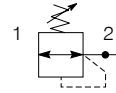

Non relieving regulator

- Manifold style regulator with line pressure on both sides.
- Pressure output is at front or rear.
- Integral 1/4 ports (BSPP & NPT)
- Robust construction
- Secondary pressure ranges 2, 4 & 8 bar
- Secondary aspiration plus balanced poppet provides quick response and accurate pressure regulation.
- Relieving & Non-relieving types
- Non-rising knob

Options:

P 3 1	HA				N		P
Thread type		Port size		Mounting			
BSPP	1	1/4	2	Plastic panel mount nut		P	
NPT	9						
Relief				Adjustment range			
Relieving				Without gauge			
Non relieving				2 bar; 30 psi; 0.2 MPa			
				4 bar; 60 psi; 0.4 MPa			
				8 bar; 125 psi; 0.8 MPa			
				Y			
				L			
				N			

Note: Only round gauges to be used on common regulator, Order gauges separately

Port size	Description	Order Code	Flow dm ³ /s (scfm) *	Max bar (psi)	Height mm (Inches)	Width mm (Inches)	Depth mm (Inches)
1/4"	8 bar (125 psi) Relieving	P31HA12BNNP	7 (16)	20 (300)	100.1 (3.94)	40 (1.58)	40 (1.58)

* flow with 6.3 bar (91.3 psig) inlet pressure and 0.34 (4.9 psig) pressure drop.

Specifications

Flow Capacity*	1/4	7 dm ³ /s (16 scfm)
Operating Temperature	-20°C (-4°F) to 65.5°C (150°F)	
Max Supply Pressure	20 bar (300 psi)	
Adjusting Range Pressure	0-2 bar (30 psi)	
	0-4 bar (60 psi)	
	0-8 bar (125 psi)	
P1 Port Size (Inlet / Outlet)	BSPP / NPT	1/4
P2 Regulated Ports (2 ea.)	BSPP / NPT	1/8
Weight	0.30 kg (0.66 lbs)	

* Inlet pressure 10 bar. Secondary pressure 6.3 bar.

Materials of Construction

Body	Zinc
Adjustment Knob	Acetal
Body Cap	ABS
Bonnet	33% Glass-filled PBT
Diaphragm Assembly	Brass / Nitrile
Bottom Plug	33% Glass-filled Nylon
Valve Assembly	Brass / Nitrile

Flow Charts

1/4 Common Regulator

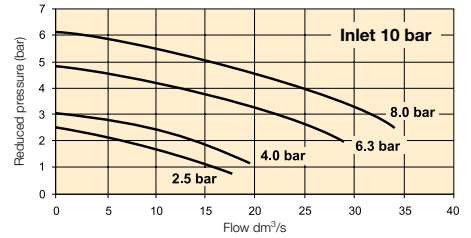

⚠ WARNING

**Product rupture can cause serious injury.
Do not connect regulator to bottled gas.
Do not exceed maximum primary pressure rating.**

Dimensions

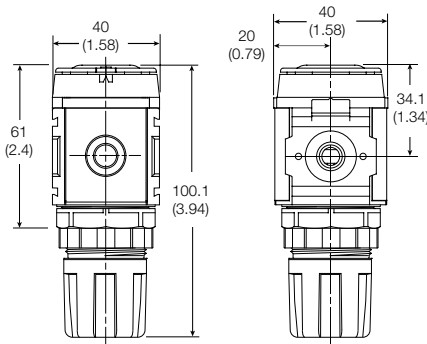

NOTE: 31.8 mm hole required for panel nut mounting.

Gauges

40mm (1 1/2") Round 1/8" center back mount

for units ordered without square gauge

0-30 PSIG / 0-2 bar	P3D-KAB1AYN
0-58 PSIG / 0-4 bar	P3D-KAB1ALN
0-160 PSIG / 0-10 bar	P3D-KAB1ANN

Repair and Service Kits

Regulator repair kit - Relieving	P31KA00RB
Regulator repair kit - Non-relieving	P31KA00RC
Panel mount nut - Aluminium	P31KA00MM
Panel mount nut - Plastic	P31KA00MP
Angle Bracket (uses panel mount threads)	P31KA00MR
T-Bracket with body connector	P31KA00MT
Body connector	P31KA00CB

CAUTION:

REGULATOR PRESSURE ADJUSTMENT – The working range of knob adjustment is designed to permit outlet pressures within their full range. Pressure adjustment beyond this range is also possible because the knob is not a limiting device. This is a common characteristic of most industrial regulators, and limiting devices may be obtained only by special design.

For best performance, regulated pressure should always be set by increasing the pressure up to the desired setting.

Compact Regulator P32



Symbols

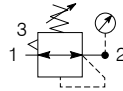

Self relieving regulator with gauge

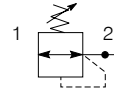

Non relieving regulator

- Integral 1/4, 3/8 or 1/2 ports (BSPP & NPT)
- Robust but lightweight aluminium construction
- Secondary pressure ranges 2, 4, 8 & 17 bar
- Secondary aspiration plus balanced poppet provides quick response and accurate pressure regulation.
- Relieving & Non-relieving types
- Non-rising knob

Options:

P 3 2	R A				N		P																																								
<table border="1"> <tr><th colspan="2">Thread type</th></tr> <tr><td>BSPP</td><td>1</td></tr> <tr><td>NPT</td><td>9</td></tr> </table>		Thread type		BSPP	1	NPT	9	<table border="1"> <tr><th colspan="2">Port size</th></tr> <tr><td>1/4</td><td>2</td></tr> <tr><td>3/8</td><td>3</td></tr> <tr><td>1/2</td><td>4</td></tr> </table>		Port size		1/4	2	3/8	3	1/2	4	<table border="1"> <tr><th colspan="2">Adjustment range</th></tr> <tr><th colspan="2">With round gauge</th></tr> <tr><td>2 bar; 30 psi; 0.2 MPa</td><td>Z</td></tr> <tr><td>4 bar; 60 psi; 0.4 MPa</td><td>M</td></tr> <tr><td>8 bar; 125 psi; 0.8 MPa</td><td>G</td></tr> <tr><td>17 bar; 250 psi; 1.7 MPa</td><td>J</td></tr> <tr><th colspan="2">Without gauge</th></tr> <tr><td>2 bar; 30 psi; 0.2 MPa</td><td>Y</td></tr> <tr><td>4 bar; 60 psi; 0.4 MPa</td><td>L</td></tr> <tr><td>8 bar; 125 psi; 0.8 MPa</td><td>N</td></tr> <tr><td>17 bar; 250 psi; 1.7 MPa</td><td>H</td></tr> </table>		Adjustment range		With round gauge		2 bar; 30 psi; 0.2 MPa	Z	4 bar; 60 psi; 0.4 MPa	M	8 bar; 125 psi; 0.8 MPa	G	17 bar; 250 psi; 1.7 MPa	J	Without gauge		2 bar; 30 psi; 0.2 MPa	Y	4 bar; 60 psi; 0.4 MPa	L	8 bar; 125 psi; 0.8 MPa	N	17 bar; 250 psi; 1.7 MPa	H	<table border="1"> <tr><th colspan="2">Mounting</th></tr> <tr><td>Plastic panel mount nut</td><td>P</td></tr> </table>		Mounting		Plastic panel mount nut	P
Thread type																																															
BSPP	1																																														
NPT	9																																														
Port size																																															
1/4	2																																														
3/8	3																																														
1/2	4																																														
Adjustment range																																															
With round gauge																																															
2 bar; 30 psi; 0.2 MPa	Z																																														
4 bar; 60 psi; 0.4 MPa	M																																														
8 bar; 125 psi; 0.8 MPa	G																																														
17 bar; 250 psi; 1.7 MPa	J																																														
Without gauge																																															
2 bar; 30 psi; 0.2 MPa	Y																																														
4 bar; 60 psi; 0.4 MPa	L																																														
8 bar; 125 psi; 0.8 MPa	N																																														
17 bar; 250 psi; 1.7 MPa	H																																														
Mounting																																															
Plastic panel mount nut	P																																														
		<table border="1"> <tr><th colspan="2">Relief</th></tr> <tr><td>Relieving</td><td>B</td></tr> <tr><td>Non relieving</td><td>N</td></tr> </table>		Relief		Relieving	B	Non relieving	N																																						
Relief																																															
Relieving	B																																														
Non relieving	N																																														

Port size	Description	Order Code	Flow dm ³ /s (scfm)	Max bar (psi)	Height mm (Inches)	Width mm (Inches)	Depth mm (Inches)
1/4"	8 bar (125 psi) Relieving	P32RA12BNNP	41 (87)	20 (300)	136 (5.4)	60 (2.36)	60 (2.36)
1/4"	8 bar (125 psi) Relieving + Gauge	P32RA12BNGP	41 (87)	20 (300)	136 (5.4)	60 (2.36)	60 (2.36)
3/8"	8 bar (125 psi) Relieving	P32RA13BNNP	65 (136)	20 (300)	136 (5.4)	60 (2.36)	60 (2.36)
3/8"	8 bar (125 psi) Relieving + Gauge	P32RA13BNGP	65 (136)	20 (300)	136 (5.4)	60 (2.36)	60 (2.36)
1/2"	8 bar (125 psi) Relieving	P32RA14BNNP	67 (142)	20 (300)	136 (5.4)	60 (2.36)	60 (2.36)
1/2"	8 bar (125 psi) Relieving + Gauge	P32RA14BNGP	67 (142)	20 (300)	136 (5.4)	60 (2.36)	60 (2.36)

* flow with 6.3 bar (91.3 psig) inlet pressure and 0.34 (4.9 psig) pressure drop.

Specifications

Flow Capacity*	1/4	41 dm ³ /s (81 scfm)
	3/8	65 dm ³ /s (138 scfm)
	1/2	67 dm ³ /s (142 scfm)
Operating Temperature	-25°C (-13°F) to 65.5°C (150°F)	
Max Supply Pressure	20 bar (300 psi)	
Adjusting Range Pressure	0-2 bar (30 psi)	
	0-4 bar (60 psi)	
	0-8 bar (125 psi)	
	0-17 bar (250 psi)	
Port Size	BSP / NPT	1/4, 3/8, 1/2
Gauge Port (2 ea.)	BSP / NPT	1/4
Weight	0.41 kg (0.90 lbs)	

* Inlet pressure 10 bar. Secondary pressure 6.3 bar.

Materials of Construction

Body	Aluminium	
Adjustment Knob	Acetal	
Body Cap	ABS	
Bonnet	33% glass-filled nylon	
Diaphragm Assembly	Nitrile / Zinc	
Bottom Plug	33% Glass-filled Nylon	
Valve Assembly	Brass / Nitrile	
Springs	Main Regulating Valve	Steel S.S.
		Nitrile
Panel Nut	Acetal	

Dimensions

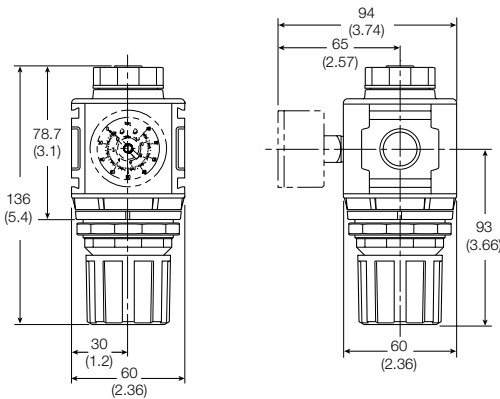

NOTE: 51 mm hole required for panel nut mounting.

⚠ WARNING

**Product rupture can cause serious injury.
Do not connect regulator to bottled gas.
Do not exceed maximum primary pressure rating.**

CAUTION:

REGULATOR PRESSURE ADJUSTMENT – The working range of knob adjustment is designed to permit outlet pressures within their full range. Pressure adjustment beyond this range is also possible because the knob is not a limiting device. This is a common characteristic of most industrial regulators, and limiting devices may be obtained only by special design. For best performance, regulated pressure should always be set by increasing the pressure up to the desired setting.

Flow Charts

1/4 Regulator

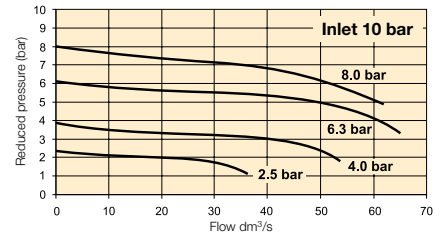

3/8 Regulator

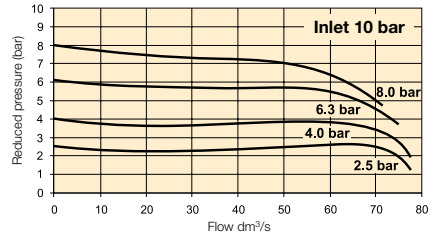

1/2 Regulator

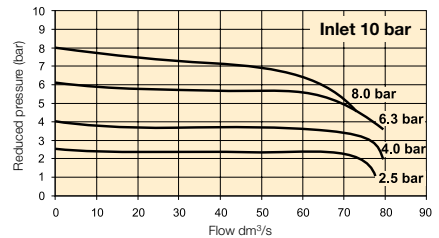

Repair and Service Kits

Regulator repair kit - Relieving	P32KA00RB
Regulator repair kit - Non-relieving	P32KA00RC
Panel mount nut - Aluminium	P32KA00MM
Panel mount nut - Plastic	P32KA00MP
Angle Bracket (uses panel mount threads)	P32KA00MR
T-Bracket with body connector	P32KA00MT
T-Bracket	P32KA00MB
Body connector	P32KA00CB

Gauges

50mm (2") Round 1/4" center back mount

for units ordered without square gauge

0-60 PSIG / 0-4 bar / 0-0.4 MPa	P6G-ERB2040
0-160 PSIG / 0-11 bar / 0-1.1 MPa	P6G-ERB2110
0-300 PSIG / 0-20 bar / 0-2 MPa	P6G-ERB2200

Compact Common P1 Regulator P32

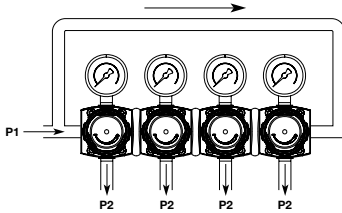

Symbols

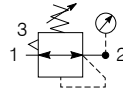

Self relieving regulator with gauge

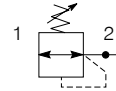

Non relieving regulator

- Manifold style regulator with line pressure on both sides.
- Pressure output is at front or rear.
- Integral 1/4, 3/8 or 1/2 ports (BSPP & NPT)
- Robust construction
- Secondary pressure ranges 2, 4, 8 & 17 bar
- Secondary aspiration plus balanced poppet provides quick response and accurate pressure regulation.
- Relieving & Non-relieving types
- Non-rising knob

Options:

P 3 2	HA				N		P
Thread type		Port size		Mounting			
BSPP	1	1/4	2	Plastic panel mount nut		P	
NPT	9	3/8	3				
		1/2	4				
Relief				Adjustment range			
Relieving				Without gauge			
Non relieving				2 bar; 30 psi; 0.2 MPa			
				4 bar; 60 psi; 0.4 MPa			
				8 bar; 125 psi; 0.8 MPa			
				17 bar; 250 psi; 1.7 MPa			
				Y			
				L			
				N			
				H			

Port size	Description	Order Code	Flow dm ³ /s (scfm)	Max bar (psi)	Height mm (Inches)	Width mm (Inches)	Depth mm (Inches)
1/4"	8 bar (125 psi) Relieving	P32HA12BNNP	28 (59)	20 (300)	136 (5.4)	60 (2.36)	60 (2.36)
3/8"	8 bar (125 psi) Relieving	P32HA13BNNP	28 (59)	20 (300)	136 (5.4)	60 (2.36)	60 (2.36)
1/2"	8 bar (125 psi) Relieving	P32HA14BNNP	28 (59)	20 (300)	136 (5.4)	60 (2.36)	60 (2.36)

* flow with 6.3 bar (91.3 psig) inlet pressure and 0.34 (4.9 psig) pressure drop.

Specifications

Flow Capacity*	1/4	28 dm ³ /s (59 scfm)
	3/8	28 dm ³ /s (59 scfm)
	1/2	28 dm ³ /s (59 scfm)
Operating Temperature	-25°C (-13°F) to 65.5°C (150°F)	
Max Supply Pressure	20 bar (300 psi)	
Adjusting Range Pressure	0-2 bar (30 psi)	
	0-4 bar (60 psi)	
	0-8 bar (125 psi)	
	0-17 bar (250 psi)	
Port Size	BSPP / NPT	1/4, 3/8, 1/2
P2 Regulated Ports (2 ea.)	BSPP / NPT	1/4
Weight	0.50 kg (1.10 lbs)	

* Inlet pressure 10 bar. Secondary pressure 6.3 bar.

Materials of Construction

Body	Zinc	
Adjustment Knob	Acetal	
Body Cap	ABS	
Bonnet	33% glass-filled nylon	
Diaphragm Assembly	Nitrile / Zinc	
Bottom Plug	33% Glass-filled Nylon	
Valve Assembly	Brass / Nitrile	
Springs	Main Regulating	Steel
	Valve	S.S.
Seals	Nitrile	
Panel Nut	Acetal	

Dimensions

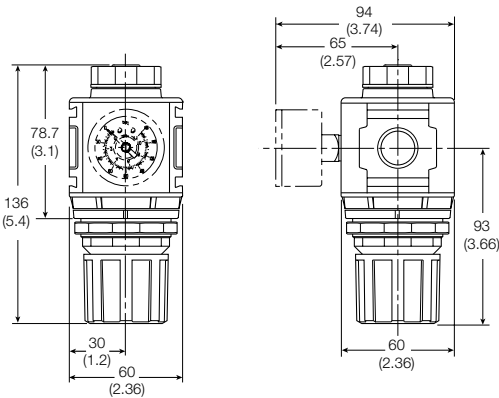

NOTE: 51 mm hole required for panel nut mounting.

WARNING

**Product rupture can cause serious injury.
Do not connect regulator to bottled gas.
Do not exceed maximum primary pressure rating.**

CAUTION:

REGULATOR PRESSURE ADJUSTMENT – The working range of knob adjustment is designed to permit outlet pressures within their full range. Pressure adjustment beyond this range is also possible because the knob is not a limiting device. This is a common characteristic of most industrial regulators, and limiting devices may be obtained only by special design. For best performance, regulated pressure should always be set by increasing the pressure up to the desired setting.

Flow Charts

P32 Common Port Regulator

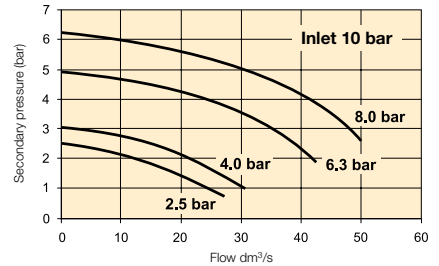

Repair and Service Kits

Regulator repair kit - Relieving	P32KA00RB
Regulator repair kit - Non-relieving	P32KA00RC
Panel mount nut - Aluminium	P32KA00MM
Panel mount nut - Plastic	P32KA00MP
Angle Bracket (uses panel mount threads)	P32KA00MR
T-Bracket with body connector	P32KA00MT
T-Bracket	P32KA00MB
Body connector	P32KA00CB

Gauges

50mm (2") Round 1/4" center back mount

for units ordered without square gauge

0-60 PSIG / 0-4 bar / 0-0.4 MPa	P6G-ERB2040
0-160 PSIG / 0-11 bar / 0-1.1 MPa	P6G-ERB2110
0-300 PSIG / 0-20 bar / 0-2 MPa	P6G-ERB2200

Standard Regulator P33



Symbols

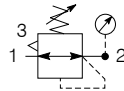

Self relieving regulator with gauge

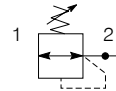

Non relieving regulator

- Integral 1/2 or 3/4 ports (BSPP & NPT)
- Robust but lightweight aluminium construction
- Secondary pressure ranges 2, 4, 8 & 17 bar
- Secondary aspiration plus balanced poppet provides quick response and accurate pressure regulation.
- Relieving & Non-relieving types
- Non-rising knob

Options:

P 3 3	R A				N		P
Thread type		Port size		Mounting			
BSPP	1	1/2	4	Plastic panel mount nut		P	
NPT	9	3/4	6				
Relief				Adjustment range			
Relieving		B		With round gauge			
Non relieving		N		2 bar; 30 psi; 0.2 MPa	Z		
				4 bar; 60 psi; 0.4 MPa	M		
				8 bar; 125 psi; 0.8 MPa	G		
				17 bar; 250 psi; 1.7 MPa	J		
				Without gauge			
				2 bar; 30 psi; 0.2 MPa	Y		
				4 bar; 60 psi; 0.4 MPa	L		
				8 bar; 125 psi; 0.8 MPa	N		
				17 bar; 250 psi; 1.7 MPa	H		

Port size	Description	Order Code	Flow dm ³ /s (scfm)	Max bar (psi)	Height mm (Inches)	Width mm (Inches)	Depth mm (Inches)
1/2"	8 bar (125 psi) Relieving	P33RA14BNNP	100 (212)	20 (300)	149 (5.9)	73 (2.9)	73 (2.9)
1/2"	8 bar (125 psi) Relieving + Gauge	P33RA14BNGP	100 (212)	20 (300)	149 (5.9)	73 (2.9)	73 (2.9)
3/4"	8 bar (125 psi) Relieving	P33RA16BNNP	100 (212)	20 (300)	149 (5.9)	73 (2.9)	73 (2.9)
3/4"	8 bar (125 psi) Relieving + Gauge	P33RA16BNGP	100 (212)	20 (300)	149 (5.9)	73 (2.9)	73 (2.9)

* flow with 6.3 bar (91.3 psig) inlet pressure and 0.34 (4.9 psig) pressure drop.

Specifications

Flow Capacity*	1/2	100 dm ³ /s (212 scfm)
	3/4	100 dm ³ /s (212 scfm)
Operating Temperature	-25°C (-13°F) to 65.5°C (150°F)	
Max Supply Pressure	20 bar (300 psi)	
Adjusting Range Pressure	0-2 bar (30 psi)	
	0-4 bar (60 psi)	
	0-8 bar (125 psi)	
	0-17 bar (250 psi)	
Port Size	BSPP / NPT	1/2, 3/4
Gauge Port (2 ea.)	BSPP / NPT	1/4
Weight	0.62 kg (1.37 lbs)	

* Inlet pressure 10 bar. Secondary pressure 6.3 bar.

Materials of Construction

Body	Aluminium	
Adjustment Knob	Acetal	
Body Cap	ABS	
Bonnet	33% Glass-filled Nylon	
Diaphragm Assembly	Nitrile / Zinc	
Valve Assembly	Brass / Nitrile / Acetal	
Springs	Main Regulating Valve	Steel S.S.
Seals	Nitrile	
Panel Nut	Acetal	

Dimensions

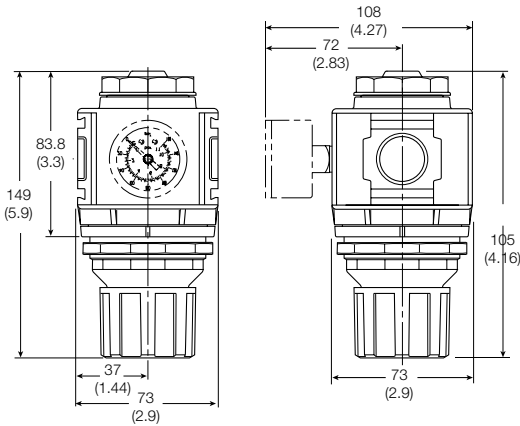

NOTE: 61 mm hole required for panel nut mounting.

⚠ WARNING

**Product rupture can cause serious injury.
Do not connect regulator to bottled gas.
Do not exceed maximum primary pressure rating.**

CAUTION:

REGULATOR PRESSURE ADJUSTMENT – The working range of knob adjustment is designed to permit outlet pressures within their full range. Pressure adjustment beyond this range is also possible because the knob is not a limiting device. This is a common characteristic of most industrial regulators, and limiting devices may be obtained only by special design. For best performance, regulated pressure should always be set by increasing the pressure up to the desired setting.

Flow Charts

1/2 Regulator

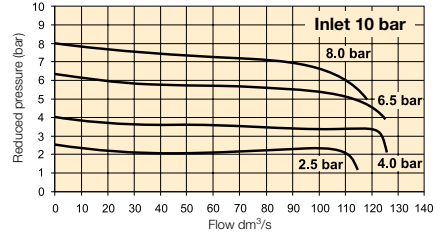

3/4 Regulator

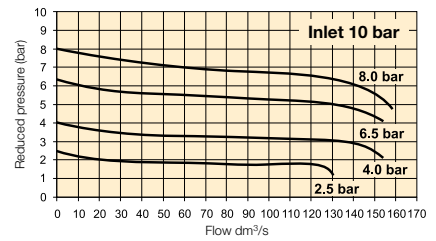

Repair and Service Kits

Regulator repair kit - Relieving	P33KA00RB
Regulator repair kit - Non-relieving	P33KA00RC
Panel mount nut - Aluminium	P33KA00MM
Panel mount nut - Plastic	P33KA00MP
Angle Bracket (uses panel mount threads)	P33KA00MR
T-Bracket with body connector	P32KA00MT
T-Bracket	P32KA00MB
Body connector	P32KA00CB

Gauges

50mm (2") Round 1/4" center back mount

for units ordered without square gauge

0-60 PSIG / 0-4 bar / 0-0.4 MPa	P6G-ERB2040
0-160 PSIG / 0-11 bar / 0-1.1 MPa	P6G-ERB2110
0-300 PSIG / 0-20 bar / 0-2 MPa	P6G-ERB2200

Mini Filter / Regulator P31



Symbols

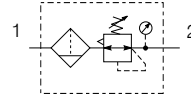

- Integral 1/4 ports (BSPP & NPT)
- High efficiency 5 micron element as standard
- Excellent water removal efficiency
- Robust but lightweight aluminium construction
- Positive bayonet latch to ensure correct & safe fitting
- Secondary pressure ranges 2, 4 & 8 bar
- Secondary aspiration plus balanced poppet provides quick response and accurate pressure regulation.

Options:

P 31	EA			E				N		P	
Thread type		Drain type		Relief		Adjustment range				Mounting	
BSPP	1	Pulse drain	B	Relieving	B	With square gauge		Without gauge		Plastic panel mount nut	P
NPT	9	Manual drain	M	Non relieving	N	2 bar *	V	2 bar	Y		
Port size		Element		Bowl type		4 bar	S	4 bar	L		
1/4	2	5µ Element	E	Poly bowl with bowl guard	G	8 bar **	T	8 bar	N		
				Metal bowl without sight glass	M	* Unit comes with 0-4 bar gauge					
				** Unit comes with 0-10 bar gauge							

Port size	Description	Order Code	Flow dm ³ /s (scfm)	Max bar (psi)	Height mm (Inches)	Width mm (Inches)	Depth mm (Inches)
1/4"	8 bar (125 psi) Relieving - Poly bowl - Manual drain	P31EA12EGMBNTP	14 (30)	10 (150)	164.1 (6.46)	40 (1.58)	64 (2.53)
1/4"	8 bar (125 psi) Relieving - Poly bowl - Pulse drain	P31EA12EGBBNTP	14 (30)	10 (150)	164.1 (6.46)	40 (1.58)	64 (2.53)
1/4"	8 bar (125 psi) Relieving - Metal bowl - Manual drain	P31EA12EMMBNTP	14 (30)	17 (250)	164.1 (6.46)	40 (1.58)	64 (2.53)
1/4"	8 bar (125 psi) Relieving - Metal bowl - Pulse drain	P31EA12EMBNTPT	14 (30)	17 (250)	164.1 (6.46)	40 (1.58)	64 (2.53)

* flow with 6.3 bar (91.3 psig) inlet pressure and 0.34 (4.9 psig) pressure drop.

Specifications

Flow Capacity*	1/4	14 dm ³ /s (30.0 scfm)
Operating Temperature	Plastic Bowl Metal Bowl	-10°C (14°F) to 52°C (125°F) -10°C (14°F) to 65.5°C (150°F)
Max Supply Pressure	Plastic Bowl Metal Bowl	10 bar (150 psi) 17 bar (250 psi)
Standard Filtration		5 Micron
Useful Retention		12 cm ³ (0.4 US oz.)
Adjusting Range Pressure		0-2 bar (30 psi) 0-4 bar (60 psi) 0-8 bar (125 psi)
Port Size	BSPP / NPT	1/4
Gauge Port (2 ea.)**	BSPP / NPT	1/8
Weight		0.19 kg (0.42 lbs)

* Inlet pressure 10 bar. Secondary pressure 6.3 bar.
** Non-gauge option only.

Air quality:

Within ISO 8573-1: 1991 Class 3 (Particulates)
Within ISO 8573-1: 2001 Class 6 (Particulates)

Materials of Construction

Body		Aluminium
Adjustment Knob		Acetal
Body Cap		ABS
Bonnet		PBT
Bowl	Plastic Bowl Metal Bowl	Polycarbonate Aluminium
Bowl Guard		Nylon
Filter Element		Polyethylene
Seals	Plastic Bowl Metal Bowl	Nitrile Nitrile
Springs		Steel
Valve Assembly		Brass / Nitrile
Diaphragm Assembly		Brass / Nitrile
Panel Nut		Acetal

For best performance, regulated pressure should always be set by increasing the pressure up to the desired setting.

Dimensions

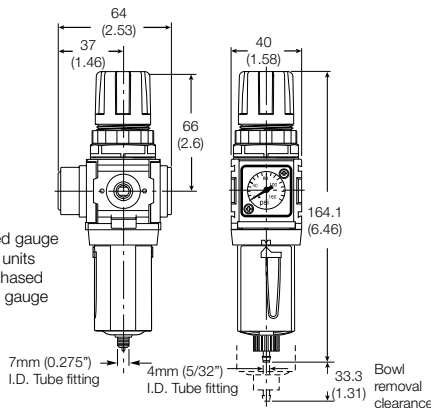

Note:
Flush-mounted gauge kits will not fit units originally purchased with threaded gauge ports.

⚠ WARNING

**Product rupture can cause serious injury.
Do not connect regulator to bottled gas.
Do not exceed maximum primary pressure rating.**

Flow Charts

1/4 Filter/Regulator

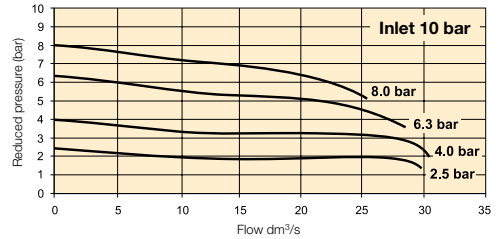

Repair and Service Kits

Plastic bowl / Bowl guard manual drain	P31KA00BGM
Metal bowl / w/o sight gauge manual drain	P31KA00BMM
Plastic bowl / Bowl guard pulse drain	P31KA00BGB
Metal bowl / w/o sight gauge pulse drain	P31KA00BMB
5µ particle filter element	P31KA00ESE
Regulator repair kit - Relieving	P31KA00RB
Regulator repair kit - Non-relieving	P31KA00RC
Panel mount nut - Aluminium	P31KA00MM
Panel mount nut - Plastic	P31KA00MP
Angle Bracket (uses panel mount threads)	P31KA00MR
C-Bracket (fits to body)	P31KA00MW
T-Bracket with body connector	P31KA00MT
Body connector	P31KA00CB

Gauges

Square flush mount gauge

replacement for unit ordered with square gauge

0-4 bar	K4511SCR04B
0-10 bar	K4511SCR11B

40mm (1 1/2") Round 1/8" center back mount

for units ordered without square gauge

0-30 PSIG / 0-2 bar	P3D-KAB1AYN
0-58 PSIG / 0-4 bar	P3D-KAB1ALN
0-160 PSIG / 0-10 bar	P3D-KAB1ANN

Compact Filter / Regulator P32



Symbols

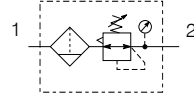

- Integral 1/4, 3/8 or 1/2 ports (BSPP & NPT)
- High efficiency 5 micron element as standard
- Excellent water removal efficiency
- Robust but lightweight aluminium construction
- Positive bayonet latch to ensure correct & safe fitting
- Secondary pressure ranges 2, 4, 8 & 17 bar
- Secondary aspiration plus balanced poppet provides quick response and accurate pressure regulation.

Options:

P 3 2	E A			E				N		P	
Thread type		Port size		Drain type		Element		Relief		Mounting	
BSPP	1	1/4	2	Manual drain	M	5µ Element	E	Relieving	B	Plastic panel mount nut	P
NPT	9	3/8	3	Auto drain	A			Non relieving	N		
		1/2	4								
		Bowl type						Adjustment range			
		Poly bowl with bowl guard						With round gauge			
		Metal bowl with sight glass		G				2 bar; 30 psi; 0.2 MPa		Z	
				S				4 bar; 60 psi; 0.4 MPa		M	
								8 bar; 125 psi; 0.8 MPa		G	
								17 bar; 250 psi; 1.7 MPa		J	
								Without gauge			
								2 bar; 30 psi; 0.2 MPa		Y	
								4 bar; 60 psi; 0.4 MPa		L	
								8 bar; 125 psi; 0.8 MPa		N	
								17 bar; 250 psi; 1.7 MPa		H	

Port size	Description	Order Code	Flow dm ³ /s (scfm)	Max bar (psi)	Height mm (Inches)	Width mm (Inches)	Depth mm (Inches)
1/4"	8 bar (125 psi) Relieving - Poly bowl - Manual drain	P32EA12EGMBNGP	42 (89)	10 (150)	254 (10.0)	60 (2.36)	60 (2.36)
1/4"	8 bar (125 psi) Relieving - Poly bowl - Auto drain	P32EA12EGABNGP	42 (89)	10 (150)	248 (9.76)	60 (2.36)	60 (2.36)
1/4"	8 bar (125 psi) Relieving - Metal bowl sight glass - Manual drain	P32EA12ESMBNGP	42 (89)	17 (250)	245 (9.66)	60 (2.36)	60 (2.36)
1/4"	8 bar (125 psi) Relieving - Metal bowl sight glass - Auto drain	P32EA12ESABNGP	42 (89)	17 (250)	248 (9.76)	60 (2.36)	95 (3.74)
3/8"	8 bar (125 psi) Relieving - Poly bowl - Manual drain	P32EA13EGMBNGP	58 (123)	10 (150)	254 (10.0)	60 (2.36)	60 (2.36)
3/8"	8 bar (125 psi) Relieving - Poly bowl - Auto drain	P32EA13EGABNGP	58 (123)	10 (150)	248 (9.76)	60 (2.36)	60 (2.36)
3/8"	8 bar (125 psi) Relieving - Metal bowl sight glass - Manual drain	P32EA13ESMBNGP	58 (123)	17 (250)	245 (9.66)	60 (2.36)	60 (2.36)
3/8"	8 bar (125 psi) Relieving - Metal bowl sight glass - Auto drain	P32EA13ESABNGP	58 (123)	17 (250)	248 (9.76)	60 (2.36)	95 (3.74)
1/2"	8 bar (125 psi) Relieving - Poly bowl - Manual drain	P32EA14EGMBNGP	64 (136)	10 (150)	245 (9.66)	60 (2.36)	95 (3.74)
1/2"	8 bar (125 psi) Relieving - Poly bowl - Auto drain	P32EA14EGABNGP	64 (136)	10 (150)	248 (9.76)	60 (2.36)	95 (3.74)
1/2"	8 bar (125 psi) Relieving - Metal bowl sight glass - Manual drain	P32EA14ESMBNGP	64 (136)	17 (250)	254 (10.0)	60 (2.36)	60 (2.36)
1/2"	8 bar (125 psi) Relieving - Metal bowl sight glass - Auto drain	P32EA14ESABNGP	64 (136)	17 (250)	248 (9.76)	60 (2.36)	60 (2.36)

* flow with 6.3 bar (91.3 psig) inlet pressure and 0.34 (4.9 psig) pressure drop.

Specifications

Flow Capacity*	1/4	42 dm ³ /s (89 scfm)
	3/8	58 dm ³ /s (123 scfm)
	1/2	64 dm ³ /s (136 scfm)
Operating Temperature	Plastic Bowl	-25°C (-13°F) to 52°C (125°F)
	Metal Bowl	-25°C (-13°F) to 65.5°C (150°F)
Max Supply Pressure	Plastic Bowl	10 bar (150 psi)
	Metal Bowl	17 bar (250 psi)
Standard Filtration		5 Micron
Useful Retention**		51 cm ³ (1.7 US oz.)
Adjusting Range Pressure		0-2 bar (30 psi)
		0-4 bar (60 psi)
		0-8 bar (125 psi)
		0-17 bar (250 psi)
Port Size	BSP / NPT	1/4, 3/8, 1/2
Gauge Port (2 ea.)	BSP / NPT	1/4
Weight		0.53 kg (1.17 lbs)

* Inlet pressure 10 bar. Secondary pressure 6.3 bar.
 ** Useful retention refers to volume below the quiet zone baffle.

Air quality:

Within ISO 8573-1: 1991 Class 3 (Particulates)
 Within ISO 8573-1: 2001 Class 6 (Particulates)

Materials of Construction

Body	Aluminium	
Adjustment Knob	Acetal	
Body Cap	ABS	
Element Retainer / Baffle	Acetal	
Bowl	Plastic Bowl	Polycarbonate
	Metal Bowl	Zinc
Bowl Guard	Nylon	
Filter Element	Sintered Polyethylene	
Seals	Plastic Bowl	Nitrile
	Metal Bowl	Nitrile
Springs	Main Regulating / Valve	Steel / S.S.
Valve Assembly	Brass / Nitrile	
Diaphragm Assembly	Nitrile / Zinc	
Panel Nut	Acetal	
Sight Gauge	Metal Bowl	Polycarbonate

Dimensions

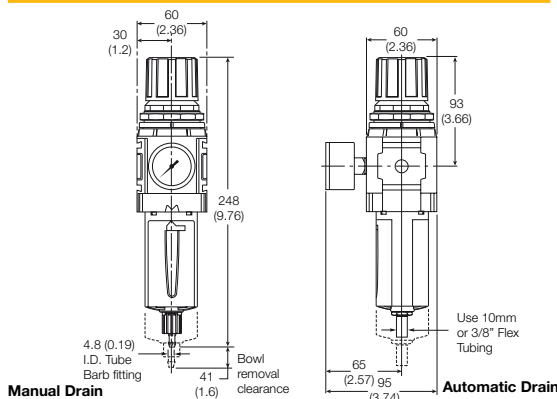

⚠ WARNING

**Product rupture can cause serious injury.
 Do not connect regulator to bottled gas.
 Do not exceed maximum primary pressure rating.**

Flow Charts

1/4 Filter/Regulator

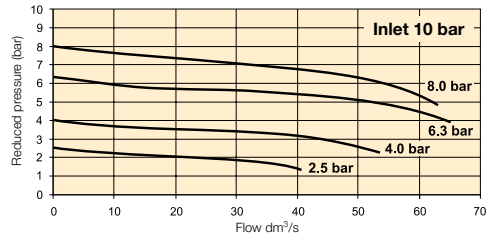

3/8 Filter/Regulator

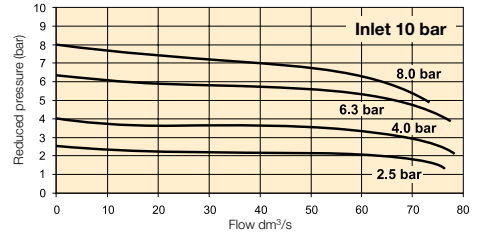

1/2 Filter/Regulator

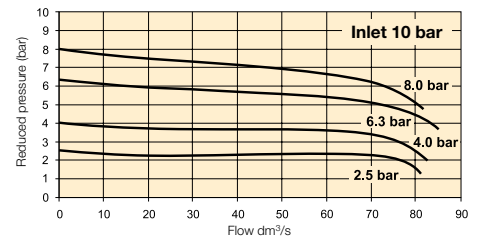

Repair and Service Kits

Plastic bowl / Bowl guard manual drain	P32KA00BGM
Metal bowl / Sight gauge manual drain	P32KA00BSM
Auto drain	P32KA00DA
5µ particle filter element	P32KA00ESE
Regulator repair kit - Relieving	P32KA00RB
Regulator repair kit - Non-relieving	P32KA00RC
Panel mount nut - Aluminium	P32KA00MM
Panel mount nut - Plastic	P32KA00MP
Angle Bracket (fits to panel mount threads)	P32KA00MR
T-Bracket (fits to body connector)	P32KA00MB
T-Bracket with body connector	P32KA00MT
Body connector	P32KA00CB

Gauges

50mm (2") Round 1/4" center back mount
 for units ordered without square gauge

0-60 PSIG / 0-4 bar / 0-0.4 MPa	P6G-ERB2040
0-160 PSIG / 0-11 bar / 0-1.1 MPa	P6G-ERB2110
0-300 PSIG / 0-20 bar / 0-2 MPa	P6G-ERB2200

For best performance, regulated pressure should always be set by increasing the pressure up to the desired setting.

Standard Filter / Regulator P33



Symbols

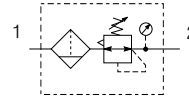

- Integral 1/2 or 3/4 ports (BSPP & NPT)
- High efficiency 5 micron element as standard
- Excellent water removal efficiency
- Robust but lightweight aluminium construction
- Positive bayonet latch to ensure correct & safe fitting
- Secondary pressure ranges 2, 4, 8 & 17 bar
- Secondary aspiration plus balanced poppet provides quick response and accurate pressure regulation.

Options:

P 33	EA			E				N		P
Thread type		Port size		Drain type		Element		Relief		Adjustment range
BSPP	1	1/2	4	Manual drain	M	5µ Element	E	Relieving	B	With round gauge
NPT	9	3/4	6	Auto drain	A			Non relieving	N	2 bar; 30 psi; 0.2 MPa Z
						Bowl type				4 bar; 60 psi; 0.4 MPa M
						Poly bowl with bowl guard	G			8 bar; 125 psi; 0.8 MPa G
						Metal bowl with sight glass	S			17 bar; 250 psi; 1.7 MPa J
										Without gauge
										2 bar; 30 psi; 0.2 MPa Y
										4 bar; 60 psi; 0.4 MPa L
										8 bar; 125 psi; 0.8 MPa N
										17 bar; 250 psi; 1.7 MPa H
										Mounting
										Plastic panel mount nut P

Port size	Description	Order Code	Flow dm ³ /s	(scfm)	Max bar	(psi)	Height mm	(Inches)	Width mm	(Inches)	Depth mm	(Inches)
1/2"	8 bar (125 psi) Relieving - Poly bowl - Manual drain	P33EA14EGMBNGP	90	(191)	10	(150)	282	(11.0)	73	(2.9)	73	(2.9)
1/2"	8 bar (125 psi) Relieving - Poly bowl - Auto drain	P33EA14EGABNGP	90	(191)	10	(150)	291	(11.44)	73	(2.9)	73	(2.9)
1/2"	8 bar (125 psi) Relieving - Metal bowl sight glass - Manual drain	P33EA14ESMBNGP	90	(191)	17	(250)	282	(11.0)	73	(2.9)	73	(2.9)
1/2"	8 bar (125 psi) Relieving - Metal bowl sight glass - Auto drain	P33EA14ESABNGP	90	(191)	17	(250)	291	(11.44)	73	(2.9)	108	(4.27)
3/4"	8 bar (125 psi) Relieving - Poly bowl - Manual drain	P33EA16EGMBNGP	98	(208)	10	(150)	282	(11.0)	73	(2.9)	108	(4.27)
3/4"	8 bar (125 psi) Relieving - Poly bowl - Auto drain	P33EA16EGABNGP	98	(208)	10	(150)	291	(11.44)	73	(2.9)	108	(4.27)
3/4"	8 bar (125 psi) Relieving - Metal bowl sight glass - Manual drain	P33EA16ESMBNGP	98	(208)	17	(250)	282	(11.00)	73	(2.9)	73	(2.9)
3/4"	8 bar (125 psi) Relieving - Metal bowl sight glass - Auto drain	P33EA16ESABNGP	98	(208)	17	(250)	291	(11.44)	73	(2.9)	73	(2.9)

* flow with 6.3 bar (91.3 psig) inlet pressure and 0.34 (4.9 psig) pressure drop.

Specifications

Flow Capacity*	1/2	90 dm ³ /s (191 scfm)
	3/4	98 dm ³ /s (208 scfm)
Operating Temperature	Plastic Bowl	-25°C (-13°F) to 52°C (125°F)
	Metal Bowl	-25°C (-13°F) to 65.5°C (150°F)
Supply Pressure	Plastic Bowl	10 bar (150 psi)
	Metal Bowl	17 bar (250 psi)
Standard Filtration		5 Micron
Useful Retention**		85 cm ³ (2.8 US oz.)
Adjusting Range Pressure		0-2 bar (30 psi)
		0-4 bar (60 psi)
		0-8 bar (125 psi)
		0-17 bar (250 psi)
Port Size	BSPP / NPT	1/2, 3/4
Gauge Port (2 ea.)	BSPP / NPT	1/4
Weight		0.85 kg (1.87 lbs)

* Inlet pressure 10 bar. Secondary pressure 6.3 bar.
** Useful retention refers to volume below the quiet zone baffle.

Air quality:

Within ISO 8573-1: 1991 Class 3 (Particulates)
Within ISO 8573-1: 2001 Class 6 (Particulates)

Materials of Construction

Body	Aluminium	
Adjustment Knob	Acetal	
Body Cap	ABS	
Element Retainer / Baffle	Acetal	
Bowls	Plastic Bowl	Polycarbonate
	Metal Bowl	Aluminium
Filter Element	Sintered Polyethylene	
Seals	Plastic Bowl	Nitrile
	Metal Bowl	Nitrile
Springs	Main Regulating / Valve	Steel / S.S.
Valve Assembly	Brass / Nitrile	
Diaphragm Assembly	Nitrile / Zinc	
Panel Nut	Acetal	
Sight Gauge	Metal Bowl	Polycarbonate

Dimensions

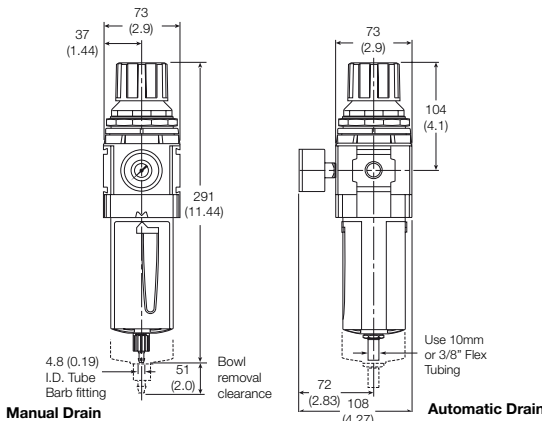

WARNING

**Product rupture can cause serious injury.
Do not connect regulator to bottled gas.
Do not exceed maximum primary pressure rating.**

Flow Charts

1/2 Filter/Regulator

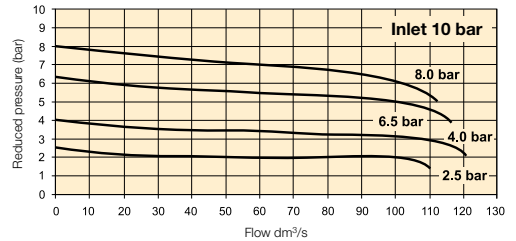

3/4 Filter/Regulator

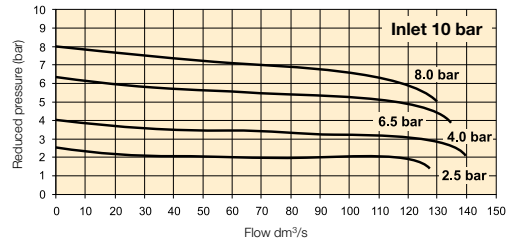

Repair and Service Kits

Plastic bowl / Bowl guard manual drain	P33KA00BGM
Metal bowl / Sight gauge manual drain	P33KA00BSM
Auto drain	P33KA00DA
5µ particle filter element	P33KA00ESE
Regulator repair kit - Relieving	P33KA00RB
Regulator repair kit - Non-relieving	P33KA00RC
Panel mount nut - Aluminium	P33KA00MM
Panel mount nut - Plastic	P33KA00MP
Angle Bracket (fits to panel mount threads)	P33KA00MR
T-Bracket (fits to body connector)	P32KA00MB
T-Bracket with body connector	P32KA00MT
Body connector	P32KA00CB

Gauges

50mm (2") Round 1/4" center back mount

for units ordered without square gauge

0-60 PSIG / 0-4 bar / 0-0.4 MPa	P6G-ERB2040
0-160 PSIG / 0-11 bar / 0-1.1 MPa	P6G-ERB2110
0-300 PSIG / 0-20 bar / 0-2 MPa	P6G-ERB2200

For best performance, regulated pressure should always be set by increasing the pressure up to the desired setting.

Mini Lubricator - P31



Symbols

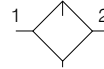

- Integral 1/4 ports (BSPP & NPT)
- Robust but lightweight aluminium construction
- Proportional oil delivery over a wide range of air flows.
- Finger tip ratchet control for precise oil drip rate adjustment

Options:

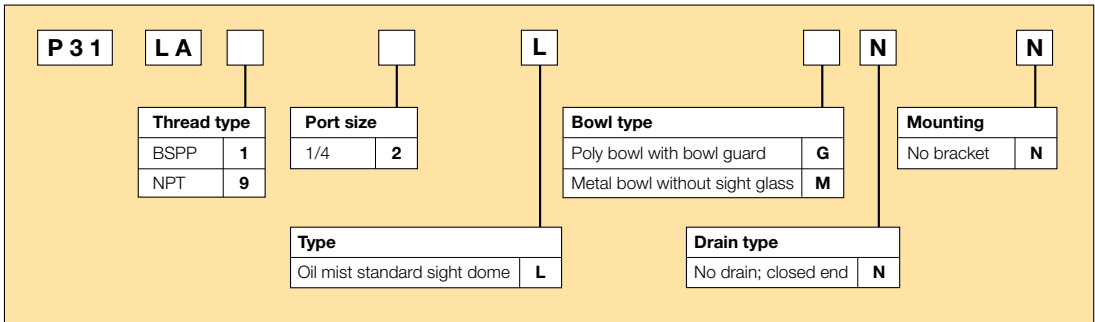

Port size	Description	Order Code	Flow dm ³ /s (scfm)	Max bar (psi)	Height mm (Inches)	Width mm (Inches)	Depth mm (Inches)
1/4"	Poly bowl - No drain	P31LA12LGNN	13 (28)	10 (150)	147.5 (5.8)	40 (1.58)	42.7 (1.68)
1/4"	Metal bowl - No drain	P31LA12LMNN	13 (28)	17 (250)	147.5 (5.8)	40 (1.58)	42.7 (1.68)

* flow with 6.3 bar (91.3 psig) inlet pressure and 0.34 (4.9 psig) pressure drop.

Specifications

Flow Capacity*	1/4	13 dm ³ /s (28 scfm)
Operating Temperature	Plastic Bowl	-10°C (14°F) to 52°C (125°F)
	Metal Bowl	-10°C (14°F) to 65.5°C (150°F)
Max Supply Pressure	Plastic Bowl	10 bar (150 psi)
	Metal Bowl	17 bar (250 psi)
Useful Retention		18 cm ³ (0.6 US oz.)
Port Size	BSP / NPT	1/4
Weight		0.13 kg (0.29 lbs)

* Inlet pressure 6.3 bar. Pressure drop 0.34 bar.

Flow Charts

1/4 Lubricator

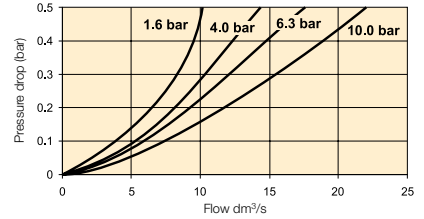

Materials of Construction

Body	Aluminium	
Body Cap	ABS	
Bowl	Plastic Bowl	Polycarbonate
	Metal Bowl	Aluminium
Seals	Plastic Bowl	Nitrile
	Metal Bowl	Nitrile
Sight Dome	Polycarbonate	
Suggested Lubricant	ISO / ASTM VG32	
Pick-up Filter	Sintered Bronze	

Dimensions

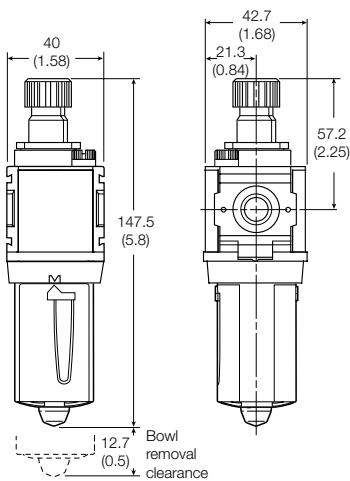

Repair and Service Kits

Plastic bowl / Bowl guard no drain	P31KA00BGN
Metal bowl / w/o sight gauge no drain	P31KA00BMN
Drip control assembly	P32KA00PG
C-Bracket (fits to body)	P31KA00MW
T-Bracket with body connector	P31KA00MT
Body connector	P31KA00CB
Lubricator Oil - VG15:ISO 3448 - 100ml	P3XKA00PPA
Lubricator Oil - VG32 - 1 litre	P3YKA00PPBB

Compact Lubricator - P32



Symbols

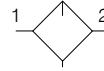

- Integral 1/4, 3/8 or 1/2 ports (BSPP & NPT)
- Robust but lightweight aluminium construction
- Proportional oil delivery over a wide range of air flows.
- Finger tip ratchet control for precise oil drip rate adjustment
- Fill from top under system pressure

Options:

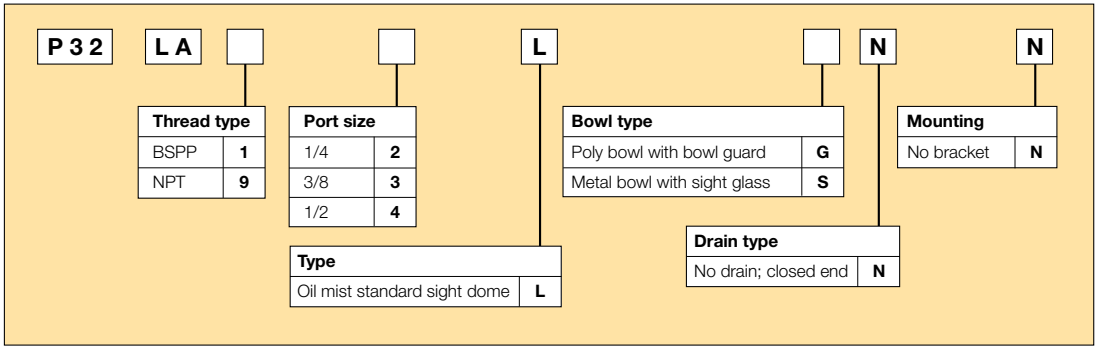

Port size	Description	Order Code	Flow dm ³ /s (scfm) *	Max bar (psi)	Height mm (Inches)	Width mm (Inches)	Depth mm (Inches)
1/4"	Poly bowl - No drain	P32LA12LGNN	18 (38)	10 (150)	211 (8.3)	60 (2.36)	60 (2.36)
1/4"	Metal bowl - No drain	P32LA12LSNN	18 (38)	17 (250)	211 (8.3)	60 (2.36)	60 (2.36)
3/8"	Poly bowl - No drain	P32LA13LGNN	32 (68)	10 (150)	211 (8.3)	60 (2.36)	60 (2.36)
3/8"	Metal bowl - No drain	P32LA13LSNN	32 (68)	17 (250)	211 (8.3)	60 (2.36)	60 (2.36)
1/2"	Poly bowl - No drain	P32LA14LGNN	47 (100)	10 (150)	211 (8.3)	60 (2.36)	60 (2.36)
1/2"	Metal bowl - No drain	P32LA14LSNN	47 (100)	17 (250)	211 (8.3)	60 (2.36)	60 (2.36)

* flow with 6.3 bar (91.3 psig) inlet pressure and 0.34 (4.9 psig) pressure drop.

Specifications

Flow Capacity*	1/4	18 dm ³ /s (38 scfm)
	3/8	32 dm ³ /s (68 scfm)
	1/2	47 dm ³ /s (100 scfm)
Operating Temperature	Plastic Bowl	-10°C (14°F) to 52°C (125°F)
	Metal Bowl	-10°C (14°F) to 65.5°C (150°F)
Max Supply Pressure	Plastic Bowl	10 bar (150 psi)
	Metal Bowl	17 bar (250 psi)
Useful Retention		121 cm ³ (4.09 US oz.)
Port Size	BSPP / NPT	1/4, 3/8, 1/2
Weight		0.31 kg (0.68 lbs)

*Inlet pressure 6.3 bar. Pressure drop 0.34 bar.

Materials of Construction

Body	Aluminium	
Body Cap	ABS	
Bowls	Plastic Bowl	Polycarbonate
	Metal Bowl	Aluminium
Seals	Plastic Bowl	Nitrile
	Metal Bowl	Nitrile
Sight Dome	Polycarbonate	
Sight Gauge	Metal Bowl	Polycarbonate
Suggested Lubricant	ISO / ASTM VG32	
Pick-up Filter	Sintered Bronze	

Flow Charts

1/4 Lubricator

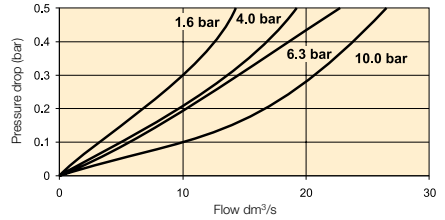

3/8 Lubricator

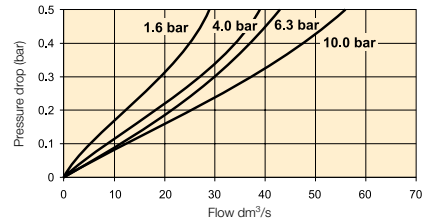

1/2 Lubricator

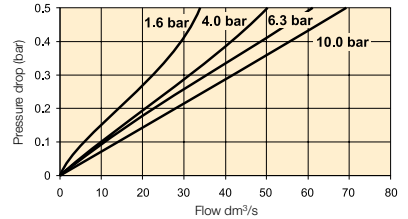

Dimensions

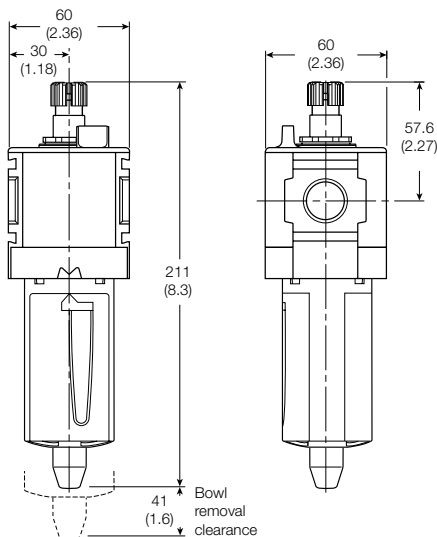

Repair and Service Kits

Plastic bowl / Bowl guard no drain	P32KA00BGN
Metal bowl / Sight gauge no drain	P32KA00BSN
Drip control assembly	P32KA00PG
L-Bracket (fits to body)	P32KA00ML
T-Bracket (fits to body connector)	P32KA00MB
T-Bracket with body connector	P32KA00MT
Body connector	P32KA00CB
Lubricator Oil - VG15:ISO 3448 - 100ml	P3XKA00PPA
Lubricator Oil - VG32 - 1 litre	P3YKA00PPBB

Standard Lubricator - P33



Symbols

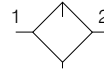

- Integral 1/2 or 3/4 ports (BSPP & NPT)
- Robust but lightweight aluminium construction
- Proportional oil delivery over a wide range of air flows.
- Finger tip ratchet control for precise oil drip rate adjustment
- Fill from top under system pressure

Options:

P 33	LA			L		N	N
Thread type		Port size		Bowl type		Mounting	
BSPP	1	1/2	4	Poly bowl with bowl guard	G	No bracket	N
NPT	9	3/4	6	Metal bowl with sight glass	S		
Type				Drain type			
Oil mist standard sight dome				No drain; closed end			
				L			
				N			

Port size	Description	Order Code	Flow dm ³ /s (scfm)	Max bar (psi)	Height mm (Inches)	Width mm (Inches)	Depth mm (Inches)
1/2"	Poly bowl - No drain	P33LA14LGNN	48 (102)	10 (150)	237.6 (9.35)	73 (2.9)	73 (2.9)
1/2"	Metal bowl - No drain	P33LA14LSNN	48 (102)	17 (250)	237.6 (9.35)	73 (2.9)	73 (2.9)
3/4"	Poly bowl - No drain	P33LA16LGNN	68 (144)	10 (150)	237.6 (9.35)	73 (2.9)	73 (2.9)
3/4"	Metal bowl - No drain	P33LA16LSNN	68 (144)	17 (250)	237.6 (9.35)	73 (2.9)	73 (2.9)

* flow with 6.3 bar (91.3 psig) inlet pressure and 0.34 (4.9 psig) pressure drop.

Specifications

Flow Capacity*	1/2	48 dm ³ /s (102 scfm)
	3/4	68 dm ³ /s (144 scfm)
Operating Temperature	Plastic Bowl	-10°C (14°F) to 52°C (125°F)
	Metal Bowl	-10°C (14°F) to 65.5°C (150°F)
Max Supply Pressure	Plastic Bowl	10 bar (150 psi)
	Metal Bowl	17 bar (250 psi)
Useful Retention		181 cm ³ (6.1 US oz.)
Port Size	BSPP / NPT	1/2, 3/4
Weight		0.47 kg (1.04 lbs)

* Inlet pressure 6,3 bar. Pressure drop 0,34 bar.

Materials of Construction

Body	Aluminium	
Body Cap	ABS	
Bowls	Plastic Bowl	Polycarbonate
	Metal Bowl	Aluminium
Seals	Plastic Bowl	Nitrile
	Metal Bowl	Nitrile
Sight Dome	Polycarbonate	
Sight Gauge	Metal Bowl	Polycarbonate
Suggested Lubricant	ISO / ASTM VG32	
Pick-up Filter	Sintered Bronze	

Flow Charts

1/2 Lubricator

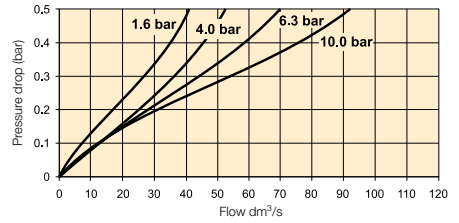

3/4 Lubricator

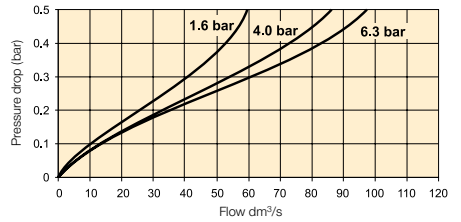

Dimensions

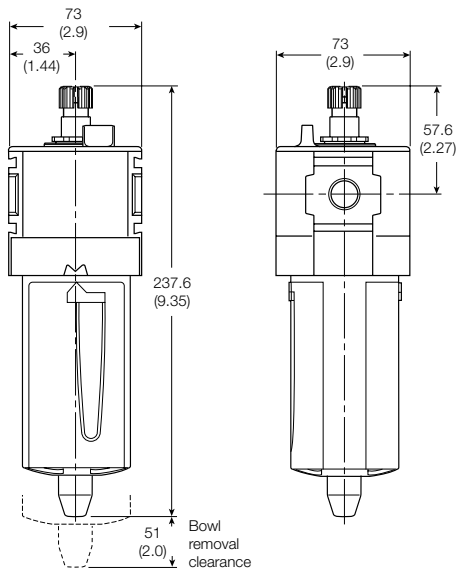

Repair and Service Kits

Plastic bowl / Bowl guard no drain	P33KA00BGN
Metal bowl / Sight gauge no drain	P33KA00BSN
Drip control assembly	P32KA00PG
L-Bracket (fits to body)	P33KA00ML
T-Bracket (fits to body connector)	P32KA00MB
T-Bracket with body connector	P32KA00MT
Body connector	P32KA00CB
Lubricator Oil - VG15:ISO 3448 - 100ml	P3XKA00PPA
Lubricator Oil - VG32 - 1 litre	P3YKA00PPBB

Combined Soft Start Dump Valve and Remote Operated Dump Valve

Symbols

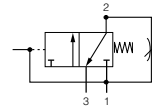

- Modular design with 1/4" or 1/2" integral ports (BSPP or NPT)
- Provides for the safe introduction of pressure
- The 3-way, 2-position function automatically dumps downstream pressure on the loss of pilot signal
- Adjustable slow start
- Solenoid or air pilot options
- High flow & exhaust capability
- Silencer included

Parker Global Series Combined Soft Start/Dump Valves, provide for the safe introduction of pressure to machines or systems. Soft Start/Dump Valves when set, allow the pressure to gradually build to the set point before fully opening to deliver full flow at line pressure.

The controlled introduction of pressure can be an important safety factor and prevent damage to tooling when air pressure is introduced at machine or system start up.

To maintain these units in the open position a pilot supply to the air pilot operated version or an electrical signal to the solenoid operated version must be maintained. The valve will automatically dump when the holding signal is removed.

Options:

P 3	<input type="checkbox"/>	T A	<input type="checkbox"/>	<input type="checkbox"/>	<input type="checkbox"/>	<input type="checkbox"/>	<input type="checkbox"/>	<input type="checkbox"/>	N	Solenoid type only	
Mini (1/4")	1	Mini (1/4")	2	External air pilot	P	None	0	Solenoid / coil not fitted	000		
Compact (1/2")	2	Compact (1/2")	4	Solenoid pilot	S	15mm (P31 series only)	C	24V DC non locking manual override	2CN		
						30mm CNOMO coil (form connection)	A				
BSPP (G)	1			15mm solenoid (P31 only)	G	30mm CNOMO coil (M12 connection)	D				
NPT	9			Threaded air pilot	P						

Note:
P32 unit used for both P32 & P33 series

Compact combined soft start dump valve

Port size	Description	Order Code	Flow dm ³ /s (scfm)	Max bar (psi)	Height mm	Width mm	Depth mm	Weight
1/4	Solenoid operated (not included)	P31TA12SGN0000	17 (36)	10 (150)	115.6 (4.5)	57 (2.2)	40 (1.5)	0.37kg (0.8lbs)
1/4	24VDC Solenoid & cable plug	P31TA12SGNC2CN	17 (36)	10 (150)	166* (6.5)	57 (2.2)	40 (1.5)	0.41kg (0.9lbs)
1/4	Air pilot operated	P31TA12PPN	17 (36)	17 (250)	115.6 (4.5)	57 (2.2)	40 (1.5)	0.37kg (0.8lbs)
1/2	Solenoid operated (not included)	P32TA14SCN0000	46 (97)	10 (150)	162.5* (6.3)	88 (3.4)	57.2 (2.2)	0.87kg (1.9lbs)
1/2	24VDC 30mm coil & cable plug incl.	P32TA14SCNA2CN	46 (97)	10 (150)	227.5* (8.9)	88 (3.4)	57.2 (2.2)	0.91kg (2.0lbs)
1/2	Air pilot operated	P32TA14PPN	46 (97)	17 (250)	162.5*(6.3)	75 (2.9)	57.2 (2.2)	0.87kg (1.9lbs)

* Includes exhaust silencer. Flow with 6.3 bar inlet and 1 bar pressure drop.

Technical Information

Fluid:	Compressed air
Max pressure Solenoid operated:	10 bar (150 psi)
Max pressure Air Pilot operated:	17 bar (250 psi)
Min operating pressure:	3 bar (44 psi)
Temperature Solenoid operated:	-10°C (14°F) to 50°C (122°F)
Temperature Air Pilot operated:	-20°C (-4°F) to 80°C (176°F)
Air Pilot port:	1/8"
Exhaust port:	P31 - 1/4" / P32 - 1/2"

Typical flow with 6.3bar inlet pressure and 1 bar pressure drop:	P31	17 dm ³ /s (36 scfm)
	P32	46 dm ³ /s (97 scfm)

* Air supply must be dry enough to avoid ice formation at temperatures below +2°C
Snap pressure: Full flow when downstream pressure reaches 50% of the inlet pressure

Material Specification

Body:	Aluminium
Body cover:	Polyester
Seals:	Nitrile NBR

P31 Series only - Solenoids 15mm NC, standard flow DIN 1.2W / 1.6 VA

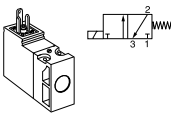
	Voltage	Weight g	Order code
	12 VDC	38	P2E-KV32B1
	24 VDC	38	P2E-KV32C1
	48 VDC	38	P2E-KV32D1
	24 VAC 50 Hz	38	P2E-KV31C1
	48 VAC 50/60 Hz	38	P2E-KV34D1
	115 VAC 50 Hz/	38	P2E-KV31F1
	120 VAC 60 Hz		
	230 VAC 50 Hz/	38	P2E-KV31J1
240 VAC 60 Hz			

Flow characteristics

1/4 Soft Start & Dump Valve

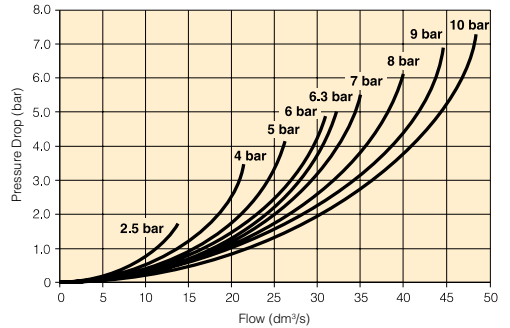

1/2 Soft Start & Dump Valve

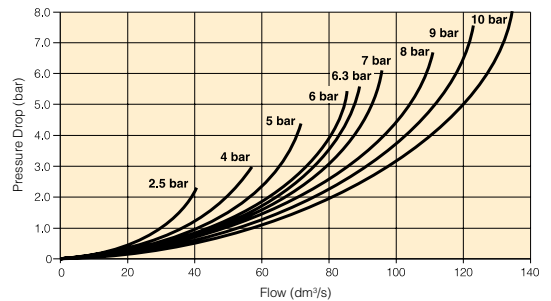

Mounting brackets

Description	Order code	Order code
	P31P	P32P
L-Bracket mounting kit	P3HKA00ML	P3KKA00ML
Foot bracket mounting kit	P3HKA00MC	P3KKA00MC

Dimensions (mm)

P31

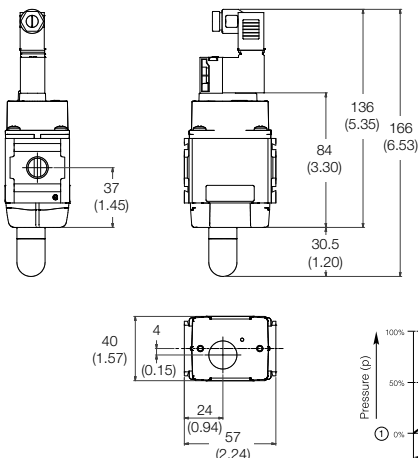

P32

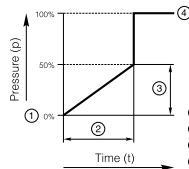
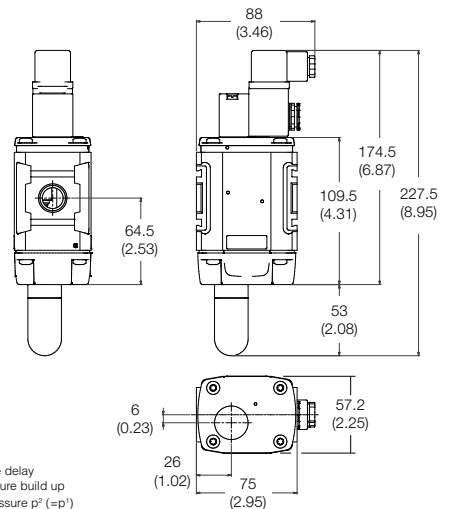

- ① Start signal
- ② Switching time delay
- ③ Gradual pressure build up
- ④ Operating pressure p² (=p¹)

For mounting brackets see page 52

Remote Operated Dump Valve

Symbols

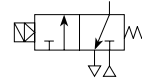

- Modular design with 1/4" or 1/2" integral ports (BSPP or NPT)
- The 3-way, 2-position function automatically dumps downstream pressure on the loss of pilot signal
- Solenoid or air pilot options
- High flow & exhaust capability
- Silencer included

Remotely operated dump valves automatically shut off upstream pressure and exhaust the downstream pressure when the pilot pressure is released.

To maintain these units in the open position a pilot supply to the air pilot operated version or an electrical signal to the solenoid operated version must be maintained. The valve will automatically dump when the holding signal is removed.

Options:

P 3		DA							N				Solenoid type only			
Mini (1/4")	1			Mini (1/4")	2	External air pilot	P			None	0	Solenoid / coil not fitted	000			
Compact (1/2")	2			Compact (1/2")	4	Solenoid pilot	S			15mm (P31 series only)	C	24V DC non locking manual override	2CN			
BSPP (G)	1					15mm solenoid (P31 only)	G			30mm CNOMO coil (form connection)	A					
NPT	9					30mm solenoid	C			30mm CNOMO coil (M12 connection)	D					
						Threaded air pilot	P									

Note:
P32 unit used for both P32 & P33 series

Remote operated dump valve

Port size	Description	Order Code	Flow dm ³ /s (scfm)	Max bar (psi)	Height mm	Width mm	Depth mm	Weight
1/4	Solenoid operated (not included)	P31DA12SGN0000	17 (36)	10 (150)	115.6 (4.5)	57 (2.2)	40 (1.5)	0.37kg (0.8lbs)
1/4	24VDC Solenoid & cable plug	P31DA12SGNC2CN	17 (36)	10 (150)	166* (6.5)	57 (2.2)	40 (1.5)	0.41kg (0.9lbs)
1/4	Air pilot operated	P31DA12PPN	17 (36)	17 (250)	115.6 (4.5)	57 (2.2)	40 (1.5)	0.37kg (0.8lbs)
1/2	Solenoid operated (not included)	P32DA14SCN0000	51 (108)	10 (150)	162.5* (6.3)	75 (2.9)	57.2 (2.2)	0.69kg (1.5lbs)
1/2	24VDC 30mm coil & cable plug incl.	P32DA14SCNA2CN	51 (108)	10 (150)	227.5* (8.9)	75 (2.9)	57.2 (2.2)	0.91kg (2.0lbs)
1/2	Air pilot operated	P32DA14PPN	51 (108)	17 (250)	162.5*(6.3)	75 (2.9)	57.2 (2.2)	0.69kg (1.5lbs)

* Includes exhaust silencer.

Technical Information

Fluid:	Compressed air	
Max pressure Solenoid operated:	10 bar (150 psi)	
Max pressure Air Pilot operated:	17 bar (250 psi)	
Min operating pressure:	3 bar (44 psi)	
Temperature Solenoid operated:	-10°C (14°F) to 50°C (122°F)	
Temperature Air Pilot operated:	-20°C (-4°F) to 80°C (176°F)	
Air Pilot port:	1/8"	
Exhaust port:	P31 - 1/4" / P32 - 1/2"	
Typical flow with 6.3bar inlet pressure and 1 bar pressure drop:	P31	17 dm ³ /s (36 scfm)
	P32	51 dm ³ /s (108 scfm)

* Air supply must be dry enough to avoid ice formation at temperatures below +2°C
Snap pressure: Full flow when downstream pressure reaches 50% of the inlet pressure

Material Specification

Body:	Aluminium
Body cover:	Polyester
Seals:	Nitrile NBR

P31 Series only - Solenoids 15mm NC, standard flow DIN 1.2W / 1.6 VA

Voltage	Weight g	Order code
12 VDC	38	P2E-KV32B1
24 VDC	38	P2E-KV32C1
48 VDC	38	P2E-KV32D1
24 VAC 50 Hz	38	P2E-KV31C1
48 VAC 50/60 Hz	38	P2E-KV34D1
115 VAC 50 Hz	38	P2E-KV31F1
120 VAC 60 Hz		
230 VAC 50 Hz/	38	P2E-KV31J1
240 VAC 60 Hz		

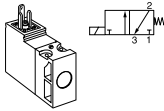

Flow characteristics

1/4 Remote Dump Valve

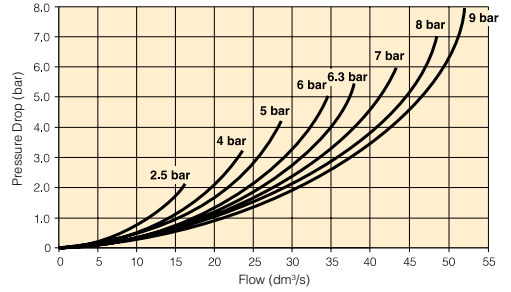

1/2 Remote Dump Valve

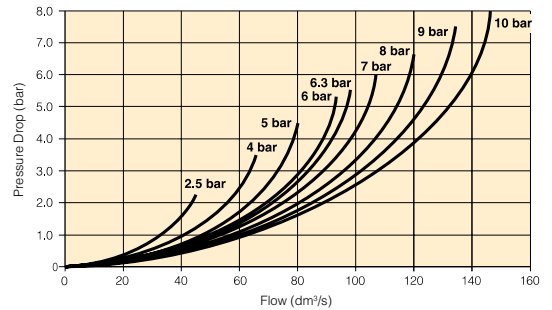

Mounting brackets

Description	Order code	Order code
	P31P	P32P
L-Bracket mounting kit	P3HKA00ML	P3KKA00ML
Foot bracket mounting kit	P3HKA00MC	P3KKA00MC

Dimensions (mm)

P31

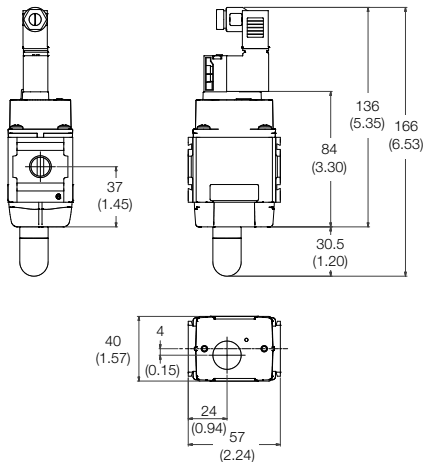

P32

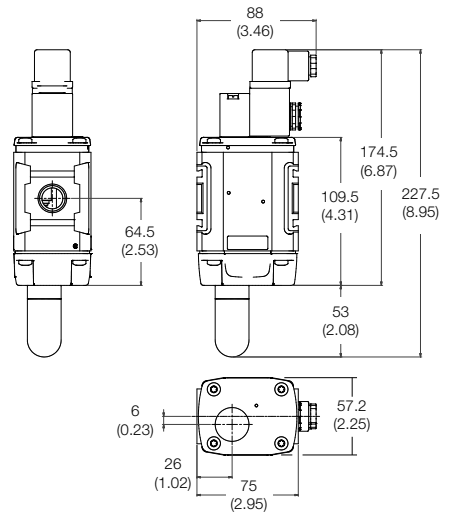

Soft Start Valve

Symbols

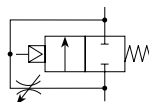

- Modular design with 1/4" or 1/2" integral ports (BSPP or NPT)
- The 2-way, 2-position function provides for the safe introduction of pressure
- Adjustable slow start
- Solenoid or air pilot options
- High flow
- Silencer included

Parker Global Series Soft Start Valves, provide for the safe introduction of pressure to machines or systems. Soft Start Valves, allow the pressure to gradually build to the set point before fully opening to deliver full flow at line pressure.

The controlled introduction of pressure can be an important safety factor and prevent damage to tooling when air pressure is introduced at machine or system start up.

Note: Soft Start Valves must be installed downstream of a 3/2 valve with exhaust capability

Options:

P3		SA				N	Solenoid type only		
Mini (1/4")	1	Mini (1/4")	2	External air pilot	P	None (For P32 series - operator is fitted to valve)	0	Solenoid / coil not fitted	000
Compact (1/2")	2	Compact (1/2")	4	Solenoid pilot	S	15mm (P31 series only)	C	24V DC non locking manual override	2CN
				Internal air pilot	Y	30mm CNOMO coil (form connection)	A		
BSPP (G)	1					30mm CNOMO coil (M12 connection)	D		
NPT	9			Internal pilot	0				
				15mm solenoid (P31 only)	G				
				30mm solenoid	C				
				Threaded air pilot	P				

Note:
P32 unit used for both P32 & P33 series

Soft start valve

Port size	Description	Order Code	Flow dm ³ /s (scfm)	Max bar (psi)	Height mm	Width mm	Depth mm	Weight
1/4	Solenoid operated (not included)	P31SA12SGN0000	17 (36)	10 (150)	115.6 (4.5)	57 (2.2)	40 (1.5)	0.37kg (0.8lbs)
1/4	24VDC Solenoid & cable plug	P31SA12SGNC2CN	17 (36)	10 (150)	166.0 (6.5)	57 (2.2)	40 (1.5)	0.41kg (0.9lbs)
1/4	External air pilot (1/8 threaded)	P31SA12PPN	17 (36)	17 (250)	115.6 (4.5)	57 (2.2)	40 (1.5)	0.37kg (0.8lbs)
1/2	Solenoid operated (not included)	P32SA14SCN0000	48 (101)	10 (150)	162.5 (6.3)	88 (3.4)	57.2 (2.28)	0.87kg (1.5lbs)
1/2	24VDC 30mm coil & cable plug	P32SA14SCNA2CN	48 (101)	10 (150)	227.5 (8.9)	88 (3.4)	57.2 (2.28)	0.90kg (2.0lbs)
1/2	Internal air pilot operated	P32SA14Y0N	48 (101)	17 (250)	162.5 (6.3)	75 (2.9)	57.2 (2.28)	0.90kg (2.0lbs)
1/2	External air pilot (1/8 threaded)	P32SA14PPN	48 (101)	17 (250)	162.5 (6.3)	75 (2.9)	57.2 (2.28)	0.87kg (1.5lbs)

Technical Information

Fluid:	Compressed air	
Max pressure Solenoid operated:	10 bar (150 psi)	
Max pressure Air Pilot operated:	17 bar (250 psi)	
Min operating pressure:	3 bar (44 psi)	
Temperature Solenoid operated:	-10°C (14°F) to 50°C (122°F)	
Temperature Air Pilot operated:	-20°C (-4°F) to 80°C (176°F)	
Air Pilot port:	1/8"	
Typical flow with 6.3bar inlet pressure and 1 bar pressure drop:	P31	17 dm ³ /s (36 scfm)
	P32	48 dm ³ /s (97 scfm)

* Air supply must be dry enough to avoid ice formation at temperatures below +2°C
Snap pressure: Full flow when downstream pressure reaches 50% of the inlet pressure

Material Specification

Body:	Aluminium
Body cover:	Polyester
Seals:	Nitrile NBR

P31 Series only - Solenoids 15mm NC, standard flow DIN 1.2W / 1.6 VA

Voltage	Weight g	Order code
12 VDC	38	P2E-KV32B1
24 VDC	38	P2E-KV32C1
48 VDC	38	P2E-KV32D1
24 VAC 50 Hz	38	P2E-KV31C1
48 VAC 50/60 Hz	38	P2E-KV34D1
115 VAC 50 Hz/ 120 VAC 60 Hz	38	P2E-KV31F1
230 VAC 50 Hz/ 240 VAC 60 Hz	38	P2E-KV31J1

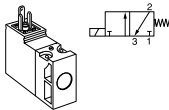

Flow characteristics

1/4 Soft Start Valve

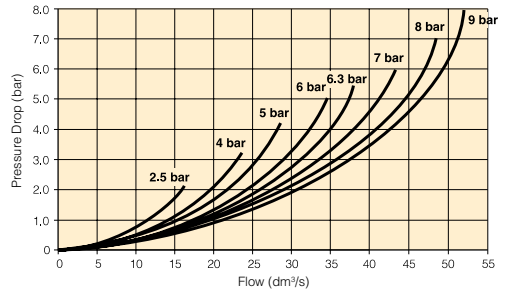

1/2 Soft Start Valve

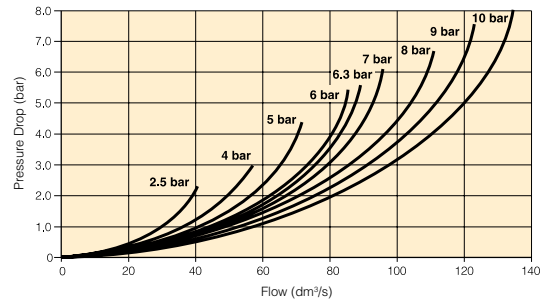

P32 Series

For other solenoid operators and cable plugs (connectors) see pages 68 to 69.

Mounting brackets

Description	Order code	Order code
	P31P	P32P
L-Bracket mounting kit	P3HKA00ML	P3KKA00ML
Foot bracket mounting kit	P3HKA00MC	P3KKA00MC

Dimensions (mm)

P31

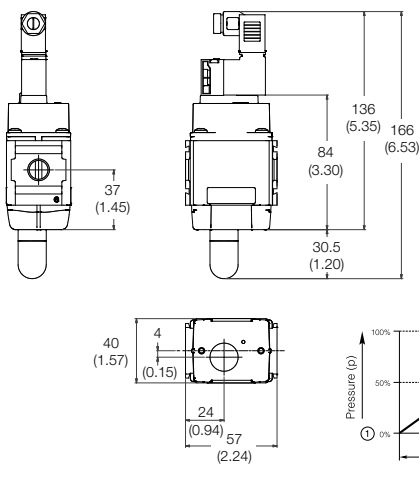

P32

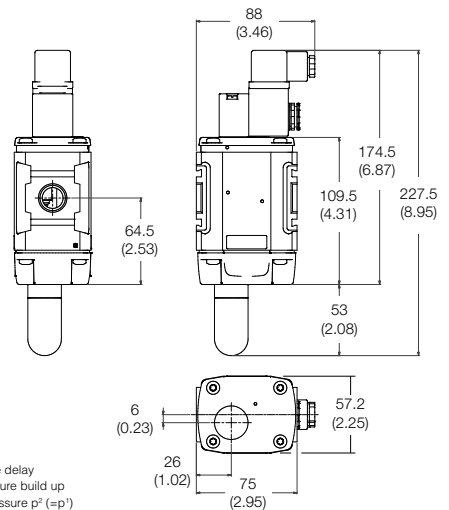

- ① Start signal
- ② Switching time delay
- ③ Gradual pressure build up
- ④ Operating pressure p² (=p¹)

Solenoid operator - CNOMO

Order key

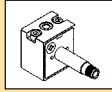
P 2 F	P	2	3	N	4	B	
Operator Type		Pressure / Temp		Manual / Override			
2 CNOMO 22 x 30 Plastic		N 10 bar / -10°C to +50°C		B Non locking - monostable - Flush - Brass			

Technical data - Solenoid operators, coil combinations

	NC Normal Operator with 30 x 30 standard coil	NC Normal Operator with 22 x 30 standard coil
Working pressure	0 to 10 bar	0 to 10 bar
Ambient temperature	-10 °C to 60 °C (1)	-10 °C to 60 °C (1)
Orifice	1.3/1.5mm	1.3/1.5mm
Flow Qn	0.84 dm ³ /s	0.84 dm ³ /s
Power (DC)	2.7W	4.8W
Power (AC)	4.9VA	8.5VA
Voltage tolerance	+/- 10%	+/- 10%
Duty cycle	100%	100%
Insulation class	F	F
Electric connection	Form A	Industrial B
Protection	IP65	IP65
Shock & Vibration	1g	1g
Approval	UL/CSA	
Working media	All neutral media such as compressed air and inert gases.	

(1) limited to 50°C if use with 100% duty cycle

Transients

Interrupting the current through the solenoid coil produces momentary voltage peaks which, under unfavourable conditions, can amount to several hundred times the rated operating voltage. Normally, these transients do not cause problems, but to achieve the maximum life of relays in the circuit (and particularly of transistors, thyristors and integrated circuits) it is desirable to provide protection by means of voltage-dependent resistors (varistors). All connectors/cable plugs EN175301-803 with LED's include this type of circuit protection.

Materials

Pilot Valve

Body:	Polyamide
Armature tube:	Brass
Plunger & core:	Corrosion resistant Cr-Ni steel
Seals:	FKM (Viton™)
Screws:	Stainless steel

Coil

Encapsulation material:	Thermoplastic as standard Duroplast for M12 connection
-------------------------	---

Solenoid coils with Din A or Industrial B connection

Voltage	30mm x 30mm		22mm x 30mm	
	Order code DIN A Standard	Weight (Kg)	Order code Industrial B standard	Weight (Kg)
Direct current				
12V DC	P2FCA445	0.105	P2FCB445	0.093
24V DC	P2FCA449	0.105	P2FCB449	0.093
48V DC	P2FCA453*	0.105	P2FCB451	0.093
Alternative current				
12V 50/60Hz	P2FCA440	0.105	P2FCB440	0.093
24V 50/60Hz	P2FCA442	0.105	P2FCB442	0.093
48V 50/60Hz	P2FCA469#	0.105		
110V 50Hz, 120V 60Hz	P2FCA453*	0.105	P2FCB453	0.093
230V 50Hz, 230V 60Hz	P2FCA457	0.105	P2FCB457	0.093

* P2FCA453 is compatible with 110 V AC and 48 V DC

P2FCA469 is 24 V DC 6.8W or 48 V 50Hz 9.9 VA

Solenoid coils with M12 connection

Voltage	Order code Form A W (Kg)		Order code Form B W (Kg)	
	30 x 30		22 x 30	
Direct current				
24V DC	P2FC6419	0.065	P2FC7419	0.065

Spare Solenoid Operators

Solenoid pilot operator CNOMO NC

Description	Order code	Weight (Kg)
Non-lock manual override		
Standard duty	P2FP23N4B	0.065

Note. Solenoid pilot operators are fitted to the Global range. Order the above part numbers for spares. The operators are supplied with mounting screws and interface 'O' rings.

Coils and connectors must be ordered separately.

Spare Solenoid Nuts



Valves requiring captured exhaust should be fitted with plastic knurled nut

Order code	
P2FNP	

Valves with vented exhaust are fitted with diffuser plastic nut

Order code	
P2FND	

Solenoid Connectors / Cable Plugs EN175301-803

	Description	Order code 15mm Form C ISO15217	Order code 22mm Form B Industrial	Order code 30mm Form A ISO4400
With large headed screw suitable for mounting in inaccessible or recess position 	Standard IP65	P8C-C		
	24V DC LED and protection IP65	P8C-C26C		
	110V AC LED and protection IP65	P8C-C21E		
With standard screw 	Standard IP65 without flying lead	P8C-D	3EV10V10	3EV290V10
	With LED and protection 24V AC/DC	P8C-D26C	3EV10V20-24	3EV290V20-24
	With LED and protection 110V AC	P8C-D21E	3EV10V20-110	3EV290V20-110
	With LED and protection 230V AC		3EV10V20-230	3EV290V20-230
With cable 	Standard with 2m cable IP65	P8L-C2		
	Standard with 5m cable IP65	P8L-C5		
	24V AC/DC, 2m cable LED and protection IP65	P8L-C226C		
	24V AC/DC, 5m cable LED and protection IP65	P8L-C526C	3EV10V20-24L5	3EV290V20-24L5
	24V AC/DC, 10m cable LED and protection IP65	P8L-CA26C		
	110V AC/DC, 2m cable LED and protection IP65	P8L-C221E		
	110V AC/DC, 5m cable LED and protection IP65	P8L-C521E	3EV10V20-110L5	3EV290V20-110L5
	230V AC, 5m cable LED and protection IP65		3EV10V20-230L5	3EV290V20-230L5

Solenoid Coil & Cable Plug Dimensions (mm)

P2F - CNOMO - 22 x 30mm

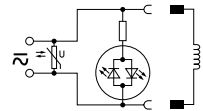
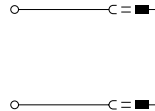
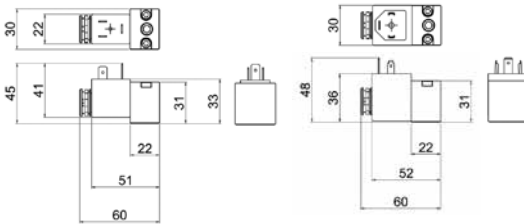

P8C-C	P8C-D26C	P8L-C226C
P8C-D	P8C-D21E	P8L-C526C
P8L-C2	P8C-C26C	P8L-CA26C
P8L-C5	P8C-C21E	P8L-C221E
3EV10V10		P8L-C521E
	3EV10V20-24	3EV10V20-24L5
	3EV10V20-110	3EV10V20-110L5
	3EV10V20-230	3EV10V20-230L5

Form C
Cable plugs

- P8C-C**
- P8C-C26C**
- P8C-C21E**
- P8C-D**
- P8C-D26C**
- P8C-D21E**

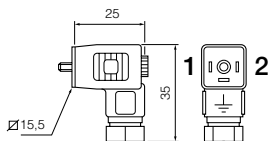

Form C
Cable plugs

- P8L-C2**
- P8LC5**
- P8L-C226C**
- P8L-C526C**
- P8L-CA26C**
- P8L-C221E**
- P8L-C521E**

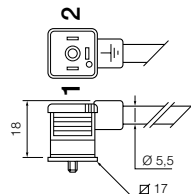

Form B
Cable plugs

- 3EV10V10**

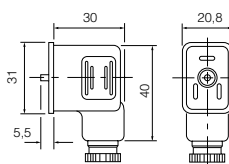

Form A
Cable plugs

- 3EV290V10**

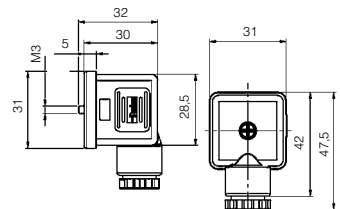

Safety Lockout Valves

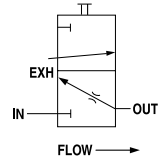

Features

The Safety Lockout valve is a manually operated, slide-type, 2-position, 3-way valve. In the closed position, downstream air pressure is exhausted to atmosphere. The valve slide can be locked in the closed position with a customer supplied padlock. The Safety Lockout valves conform to OSHA #29 CFR part 1910 – control of hazardous energy source (lockout / tagout).

Ordering Information

Model	Type	Port Size	Thread type	Safety Lockout Valve Flow from left to right
P31		1/4	BSPP	P31VA12LSAN
P32		1/4	BSPP	P32VA12LSAN
		3/8	BSPP	P32VA13LSAN
		1/2	BSPP	P32VA14LSAN
P33		1/2	BSPP	P33VA14LSAN
		3/4	BSPP	P33VA16LSAN

Model	Type	Port Size	Thread type	Safety Lockout Valve Flow from right to left
P32		1/4	BSPP	P32VA12LSBN
		3/8	BSPP	P32VA13LSBN
		1/2	BSPP	P32VA14LSBN
P33		1/2	BSPP	P33VA14LSBN
		3/4	BSPP	P33VA16LSBN

Specifications

Operating Temperature	P31	-10°C (14°F) to 65.5°C (150°F)	
	P32/P33	-25°C (-13°F) to 65.5°C (150°F)	
Max Supply Pressure	10 bar (150 psi)		
Port Size	BSPP / NPT	1/4, 3/8, 1/2, 3/4	
Weight	P31:	0.30 kg (0.66 lbs)	
	P32:	0.34 kg (0.74 lbs)	
	P33:	0.41 kg (0.90 lbs)	
Flow Capacity	P31:	1/4	47 dm ³ /s (100 scfm)
		3/8	66 dm ³ /s (141 scfm)
	P32:	1/4	100 dm ³ /s (216 scfm)
		1/2	128 dm ³ /s (272 scfm)
	P33:	1/2	136 dm ³ /s (290 scfm)
		3/4	140 dm ³ /s (300 scfm)

Materials of Construction

Body	Zinc
Blade	Acetal
Seals	Nitrile

For thread type: NPT **9**

Dimensions

P31

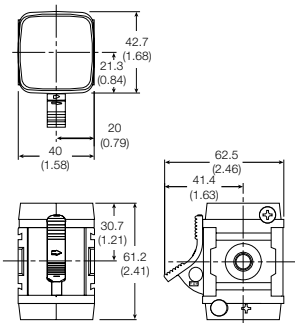

P32

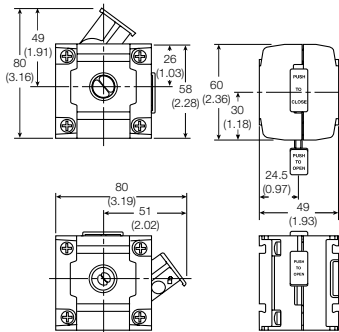

P33

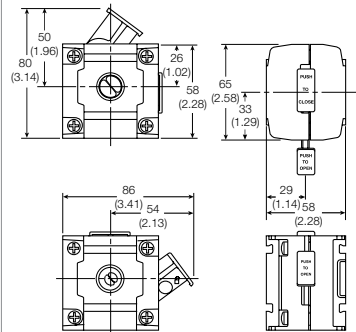

Manifold Blocks

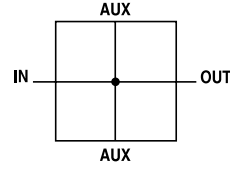

Features

- Available in 1/4 or 3/4 threaded inlet / outlet ports
- Two additional top and bottom auxiliary ports standard
- Can be mounted anywhere in the FRL system
- Includes one pipe plug

Ordering Information

Model Type	In / Out Port Size	Auxiliary Port Size Top	Auxiliary Port Size Bottom	Thread Type	Order Code
P31	1/4	1/4	1/4	BSPP	P31MA12022N
P32/P33	3/4	1/4	1/2	BSPP	P33MA16024N

For thread type: NPT **9**

Specifications

Max Operating Temperature	65.5°C (150°F)
Max Supply Pressure	20.7 bar (300 psi)
Port Size (In / Out)	P31: 1/4 P33: 3/4
Auxiliary Port Size - Top	P31: 1/4 P33: 1/4
Auxiliary Port Size - Bottom	P31: 1/4 P33: 1/2
Weight	P31: 0.19 kg (0.26 lbs) P33: 0.34 kg (0.42 lbs)

Materials of Construction

Body Aluminium

Dimensions

P31

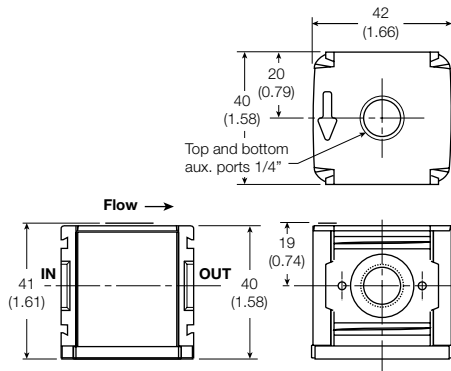

P32 / P33

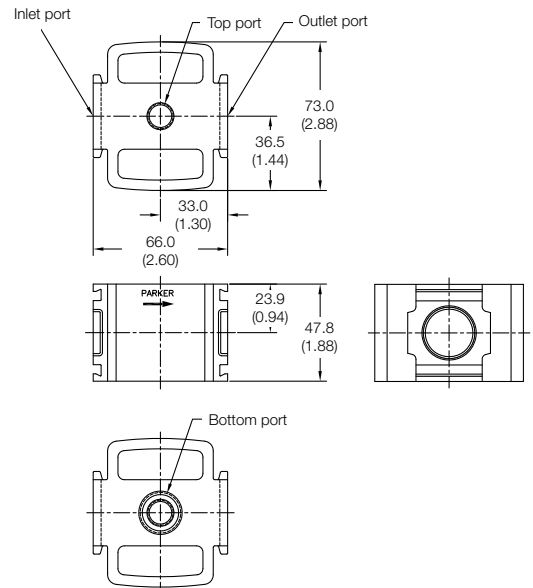

Accessories - P31 Series

C-Bracket
(Fits to filter and lubricator body)
P31KA00MW

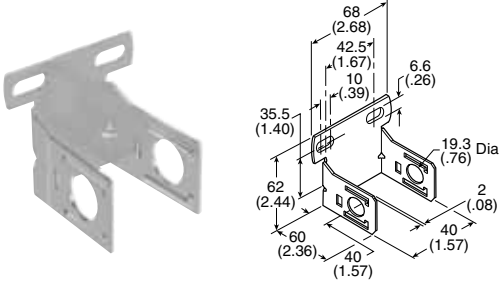

T-Bracket w/ Body Connector
P31KA00MT

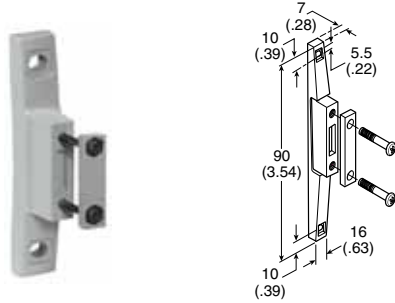

Body Connector
(O-ring not shown)
P31KA00CB

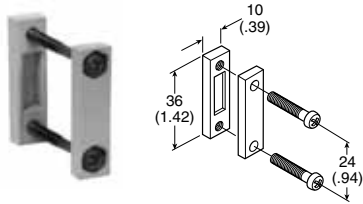

Port Block Kit

- 1/4 NPT P31KA92CP
- 3/8 NPT..... P31KA93CP
- G 1/4 P31KA12CP
- G 3/8..... P31KA13CP



Body Connector

'O' ring Kit
Pack of 5 P31KA00CY



Port Block Kit
w/ T-Bracket

- 1/4 NPT P31KA92CN
- 3/8 NPT..... P31KA93CN
- G 1/4 P31KA12CN
- G 3/8..... P31KA13CN



Angle Bracket
(Fits to regulator and filter/regulator body)

P31KA00MR

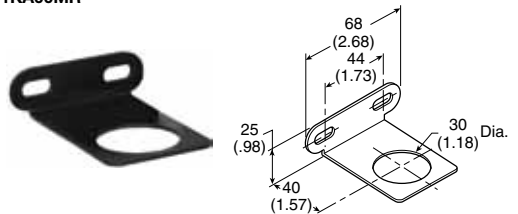

Accessories - P32 Series

T-Bracket w/ Body Connector
P32KA00MT

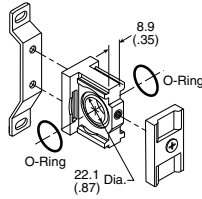

Body Connector
P32KA00CB

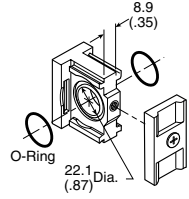

Body Connector
'O' ring Kit
 Pack of 5 **P32KA00CY**



Port Block Kit

- 1/4 NPT.....**P32KA92CP**
- 3/8 NPT.....**P32KA93CP**
- 1/2 NPT.....**P32KA94CP**
- 3/4 NPT.....**P32KA96CP**
- G 1/4**P32KA12CP**
- G 3/8**P32KA13CP**
- G 1/2.....**P32KA14CP**
- G 3/4.....**P32KA16CP**

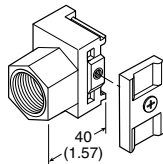

Angle Bracket
P32KA00MR

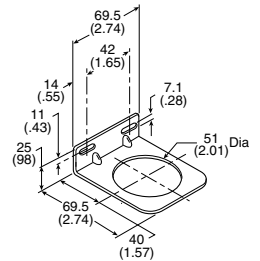

L-Bracket
 (Fits to filter and lubricator body)
P32KA00ML

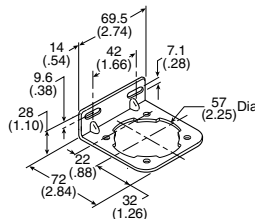

T-Bracket
 (fits to body connector or port block)
P32KA00MB

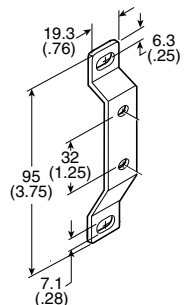

Accessories - P33 Series

T-Bracket w/ Body Connector
P32KA00MT

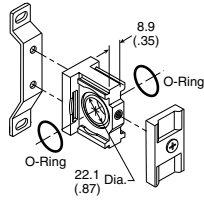

Body Connector
P32KA00CB

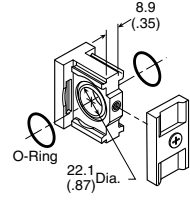

Body Connector
'O' ring Kit

Pack of 5 **P32KA00CY**



Port Block Kit

- 1/4 NPT.....**P32KA92CP**
- 3/8 NPT.....**P32KA93CP**
- 1/2 NPT.....**P32KA94CP**
- 3/4 NPT.....**P32KA96CP**
- G 1/4**P32KA12CP**
- G 3/8**P32KA13CP**
- G 1/2**P32KA14CP**
- G 3/4**P32KA16CP**

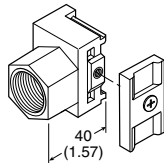

Angle Bracket
(Fits to regulator and filter/regulator bonnet)
P33KA00MR

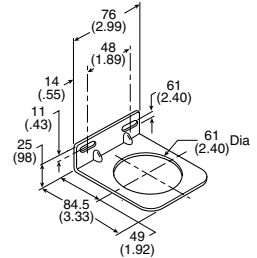

L-Bracket
(Fits to filter and lubricator body)
P33KA00ML

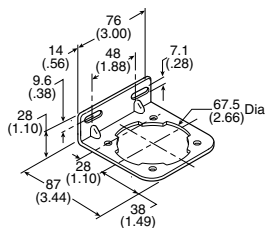



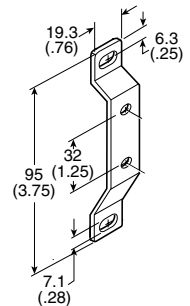

T-Bracket
(fits to body connector or port block)
P32KA00MB



Accessories Kits

Series	Description	Connection	Order Code	
P31 P32 P33	Panel Mount Nut (Plastic)		P31KA00MP P32KA00MP P33KA00MP	
P31 P32 P33	Panel Mount Nut (Aluminium)		P31KA00MM P32KA00MM P33KA00MM	
P31 P32 P33	5µ Element Kit		P31KA00ESE P32KA00ESE P33KA00ESE	
P31 P32 P33	1µ Element Kit		P31KA00ES9 P32KA00ES9 P33KA00ES9	
P31 P32 P33	0.01µ Element Kit		P31KA00ESC P32KA00ESC P33KA00ESC	
P31 P32 P33	Adsorber Element Kit		P31KA00ESA P32KA00ESA P33KA00ESA	
P32 / P33	Auto Drain Kit		P32KA00DA	
P32 / P33	Differential Pressure Indicator Kit		P32KA00RQ	
P31 P32 P33	Plastic Bowl with Bowl Guard & Manual Drain		P31KA00BGM P32KA00BGM P33KA00BGM	
P31	Plastic Bowl with Bowl Guard & Pulse Drain		P31KA00BGB	
P32 P33	Plastic Bowl with Bowl Guard & Auto Drain		P32KA00BGA P33KA00BGA	

Accessories Kits

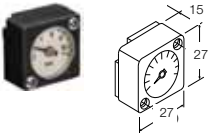
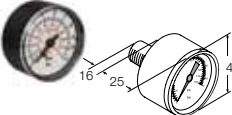
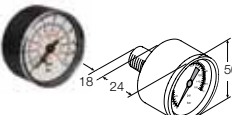
Series	Description	Connection	Order Code	
P31	Metal Bowl without Sight Gauge & Pulse Drain		P31KA00BMB	
P32 P33	Metal Bowl with Sight Gauge & Manual Drain		P32KA00BSM P33KA00BSM	
P32 P33	Metal Bowl with Sight Gauge & Auto Drain		P32KA00BSA P33KA00BSA	
P31 P32 P33	Lubricator - Plastic Bowl with Bowl Guard & Close End		P31KA00BGN P32KA00BGN P33KA00BGN	
P31 P32 P33	Lubricator - Metal Bowl Without Sight Gauge, No Drain Lubricator - Metal Bowl With Sight Gauge, No Drain Lubricator - Metal Bowl With Sight Gauge, No Drain		P31KA00BMN P32KA00BSN P33KA00BSN	
P31 P32 P33	Regulator - Relieving Repair Kit		P31KA00RB P32KA00RB P33KA00RB	
P31 P32 P33	Regulator - Non Relieving Repair Kit		P31KA00RC P32KA00RC P33KA00RC	
P31	Square Flush Mounting Gauge Kit	0-4 bar 0-10 bar	K4511SCR04B K4511SCR11B	
P31	40mm Round Gauge	0-30 psi / 0-2 bar 0-60 psi / 0-4.1 bar 0-160 psi / 0-10 bar	P3D-KAB1AYN P3D-KAB1ALN P3D-KAB1ANN	
P32 / P33	50mm Round Gauge	0-60 psi / 0-4.1 bar 0-160 psi / 0-10 bar 0-300 psi / 0-20 bar	P6G-ERB2040 P6G-ERB2110 P6G-ERB2200	



P3X Series Moduflex Lite Air Preparation System

G1/2 & G3/4 Body Ported

New Technology

The Moduflex Lite FRL system is constructed from ultra light weigh technopolymers instead of the traditional aluminium or zinc die cast, this means that is up to 45% lighter than conventional units. This non-metal construction also means that the Moduflex Lite is corrosion free enabling it to be used in harsh industrial environments where anti freeze or aggressive synthetic oils are present.

The use of technopolymers in the design of Moduflex Lite has facilitated a universal body design, this has resulted in reducing the number of variants required to cover the full spectrum of applications. This can dramatically lower logistic costs and simplify stock holding for customers making the Moduflex Lite a very cost effective solution.



New Nano Mist Technology, New Lubricator Concept. Self-Adjusting.

With conventional lubricators, only the oil volume per time unit can be adjusted. If the demand changes, the quantity dispensed still remains constant.

The Moduflex Lite lubricator concept sets new benchmarks here. For the first time, the oil volume is automatically adjusted to the flow rate. This ensures that there is neither too little nor too much oil in the system, which leads to clear economic and ecological advantages. In addition, with conventional systems, the distance between the lubricator and the equipment has to be less than 8 meters. With larger distances, the dispensed oil is deposited as a wall flow. The new lubricator principle of the Moduflex Lite allows for distances of up to 40 meters. This opens up new scope for the design of even more efficient production systems.



Popular Combinations

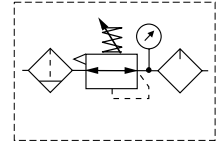

Slide Valve + Filter/Regulator + Lubricator Combinations (50mg/m³)
5 micron element, 8 bar Regulator + Gauge and Wall Mounting Brackets

Port size	Combined Manual/Semi-Auto Drain	Flow dm ³ /s	Weight (g)	Auto Drain	Flow dm ³ /s	Weight (g)
G ¹ / ₂	P3XAA14GECNGPNW	76	1300	P3XAA14GEANGPNW	76	1300
G ³ / ₄	P3XAA16GECNGPNW	77	1300	P3XAA16GEANGPNW	77	1300

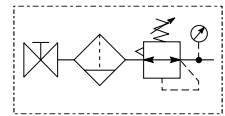

Slide Valve + Filter/Regulator Combinations
5 micron element, 8 bar Regulator + Gauge and Wall Mounting Brackets

Port size	Combined Manual/Semi-Auto Drain	Flow dm ³ /s	Weight (g)	Auto Drain	Flow dm ³ /s	Weight (g)
G ¹ / ₂	P3XAN14GECNGW	105	950	P3XAN14GEANGW	105	950
G ³ / ₄	P3XAN16GECNGW	106	950	P3XAN16GEANGW	106	950

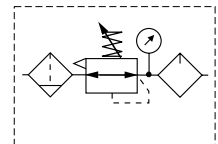

Filter/Regulator + Lubricator Combinations (50mg/m³)
5 micron element, 8 bar Regulator + Gauge and Wall Mounting Brackets

Port size	Combined Manual/Semi-Auto Drain	Flow dm ³ /s	Weight (g)	Auto Drain	Flow dm ³ /s	Weight (g)
G ¹ / ₂	P3XCA14GECNGPNW	76	1000	P3XCA14GEANGPNW	76	1000
G ³ / ₄	P3XCA16GECNGPNW	77	1000	P3XCA16GEANGPNW	77	1000

Options:

P 3 X				G E		N		P N	W
Filter/Reg + Lubricator	CA	BSPP (G)	1	Combined Manual/Semi Auto Drain	C	0 - 8 bar with gauge	G	Add only for options with lubricator	
Slide valve + Filter/Reg	AN	NPT *	9			0 - 16 bar with gauge			
Slide valve + Filter/Reg + Lubricator	AA			Auto Drain	A				
		1/2	4						
		3/4	6						

* NPT ports on request
1/2" size only

Filter



Symbols

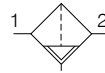

Manual / Semi auto drain

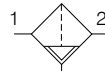

Auto drain

- Integral 1/2 or 3/4" ports
- 2 stage filtration
- High efficiency 5µ particulate element as standard
- Excellent water removal efficiency

Options:

P 3 X F A					G		N
BSPP (G)	1	1/2	4	5 Micron Element Standard	E	Combined Manual/Semi Auto Drain	C
NPT *	9	3/4	6	40 Micron Element Optional	G	Auto Drain	A
				1 Micron Dust Filter	2		

* NPT ports on request
1/2" size only

Port size	Description	Order Code	Flow dm ³ /s *	Max bar	Min temp °C	Max temp °C	Bowl capacity cm ³	Height mm	Width mm	Depth mm	Weight g
1/2	Combined manual/ semi auto drain	P3XFA14EGCN	55	16	-10	60	60	192	62	62	320
1/2	Auto drain	P3XFA14EGAN	55	16	-10	60	60	192	62	62	320
3/4	Combined manual/ semi auto drain	P3XFA16EGCN	57	16	-10	60	60	192	62	62	320
3/4	Auto drain	P3XFA16EGAN	57	16	-10	60	60	192	62	62	320

* flow with 6,3 bar inlet pressure and 0,5 pressure drop.

Technical Information

Fluid:	Compressed air
Maximum inlet pressure:	16 bar
Temperature range*:	-10°C to +60°C
Particle removal:	1, 5 & 40 micron
Air quality:	Within ISO 8573-1 : 1991 Class 3 and 5 (particulates) Within ISO 8573-1 : 2001 Class 6 and 7 (particulates)
Typical flow with 5µm element 6,3 bar inlet pressure and 0.5 bar pressure drop:	1/2" size 55 dm ³ /s
Semi-auto drain: bowl pressure to close drain	0.8 bar
Auto drain: bowl pressure to close drain Operating range manual override facility	0.8 bar 0.8 to 16 bar
Bowl sump capacity:	60 cm ³

* Air supply must be dry enough to avoid ice formation at temperatures below +2°C

Material Specification

Body:	High tech polymer
Sight glass:	Polypropylene
Body cover:	ABS
Element:	Sintered P.E.
Seals:	Nitrile NBR
Drains:	Manual / Semi-auto: Acetal
	Automatic: PA / Brass

Dimensions (mm)

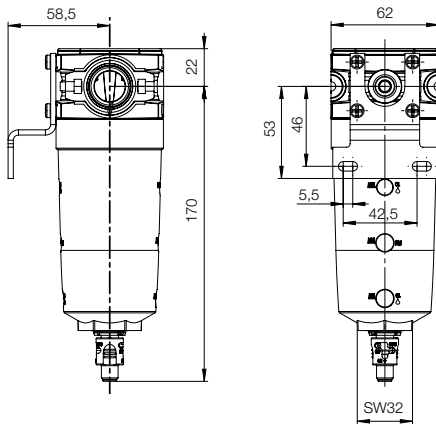

Service kits

Description	Order code
5 micron element kit	P3XKA00ESE
40 micron element kit	P3XKA00ESG
Bowl kit with combines manual/semi auto drain	P3XKA00BSC
Bowl kit with auto drain	P3XKA00BSA
1 micron element kit	P3XKA00ES9

Flow characteristics

(1/2) 5 Micron Filter

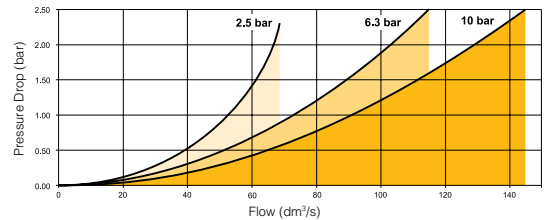

(3/4) 5 Micron Filter

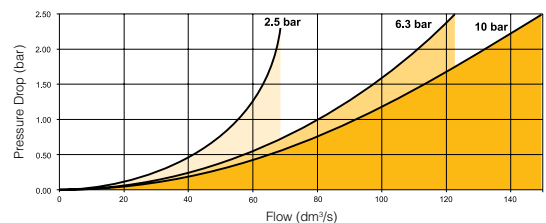

Coalescing Filter



- Integral 1/2 or 3/4 ports
- Removes liquid aerosols and sub micron particles
- Oil free air for critical applications, such as air gauging, pneumatic instrumentation and control

Note: To optimise the life of the coalescing element, it is advisable to install a P3XFA pre-filter with a 5 micron element upstream of the coalescing filter.

Options:

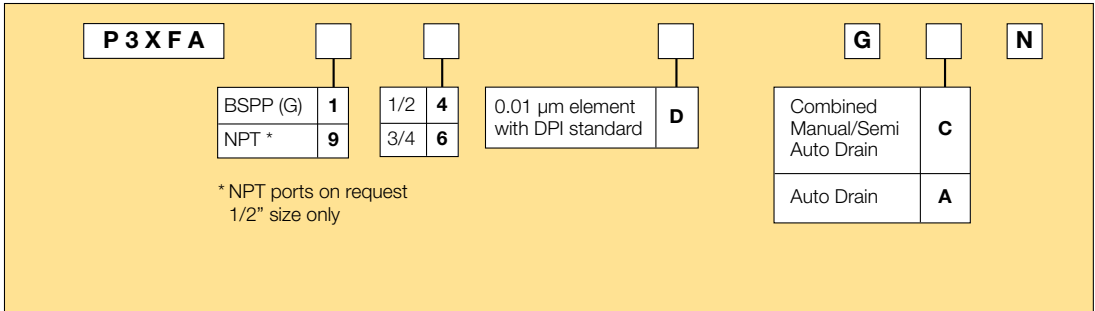

Port size	Description	Order Code	Flow dm ³ /s *	Max bar	Min temp °C	Max temp °C	Bowl capacity cm ³	Height mm	Width mm	Depth mm	Weight g
1/2	Coalescing Filter 0.01µm, Combined manual/semi auto drain	P3XFA14DGCN	24	16	-10	60	60	217	62	62	320
1/2	Coalescing Filter 0.01µm, auto drain	P3XFA14DGAN	24	16	-10	60	60	217	62	62	320
3/4	Coalescing Filter 0.01µm, Combined manual/semi auto drain	P3XFA16DGCN	24	16	-10	60	60	217	62	62	320
3/4	Coalescing Filter 0.01µm, auto drain	P3XFA16DGAN	24	16	-10	60	60	217	62	62	320

* flow with 6,3 bar inlet pressure and 0,2 pressure drop.

Technical Information

Fluid:	Compressed air
Maximum inlet pressure:	16 bar
Temperature range*:	-10°C to +60°C
Media specifications:	
Coalescing efficiency	(0.3 to 0.6 micron particles): 99.97%
Max. oil carryover (PPM w/w):	0.008 mg/m ³
Typical flow element @ 6,3 bar inlet pressure and 0.2 bar pressure drop:	16 dm ³ /s
Manual / Semi-auto drain: Bowl pressure to close drain	0.8 bar
Auto drain: bowl pressure to close drain Operating range manual override facility	0.8 bar 0.8 to 16 bar
Bowl sump capacity:	60 cm ³

* Air supply must be dry enough to avoid ice formation at temperatures below +2°C

Material Specification

Body:	High tech polymer
Sight glass:	Polypropylene
Filter cover:	ABS
Coalescing element:	Borosilicate & Nano fibres
Top & bottom end cap:	Glass filled nylon - Black
Support cylinders:	Grade 430 stainless steel
Support media:	Polypropylene
Anti re-entrainment barrier:	Polyester
Ensapulate:	Epoxy resin / Hardener
Seals:	Nitrile NBR
Drains:	Manual / Semi-auto: Acetal Automatic: PA / Brass
Differential pressure indicator materials:	
Body:	Acetal
Internal parts:	Acetal
Spring:	Stainless steel
Seals:	Nitrile NBR
Screws:	Steel / zinc plated

Dimensions (mm)

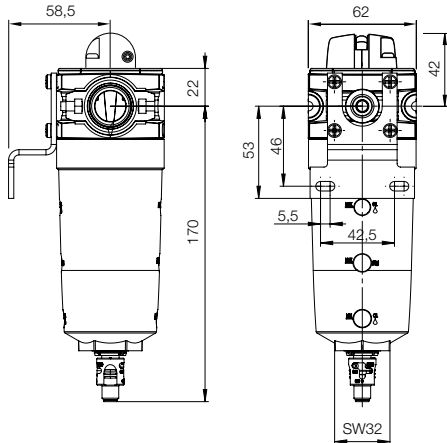

Service kits

Description	Order code
0.01 micron coalescing element kit	P3XKA00ESC
Bowl kit with combines manual/semi auto drain	P3XKA00BSC
Bowl kit with auto drain	P3XKA00BSA
Differential pressure indicator kit	P3XKA00RQ

Flow characteristics

(1/2) 0.01µm Coalescing Filter Saturated

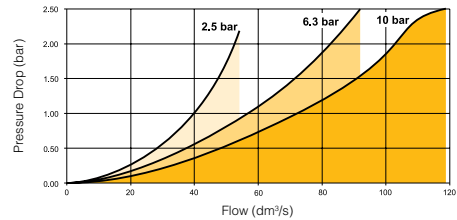

(3/4) 0.01µm Coalescing Filter Saturated

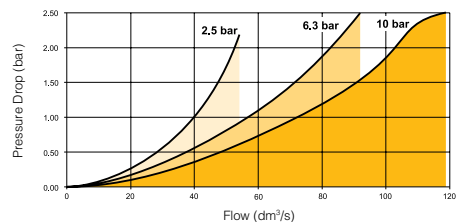

Adsorber Filter



- Integral 1/2 or 3/4 ports
- Adsorber activated carbon element removes oil vapours and most hydrocarbons

Note: To optimise the life of the adsorber element, it is advisable to install a P3X coalescing 0.01 µm filter upstream of the adsorber filter.

Options:

P 3 X F A	□	□	A	G C N
	BSP (G)	1	1/2	4
	NPT *	9	3/4	6
			Adsorber element	A

* NPT ports on request
1/2" size only

Port size	Description	Order Code	Flow dm ³ /s *	Max bar	Min temp °C	Max temp °C	Bowl capacity cm ³	Height mm	Width mm	Depth mm	Weight g
1/2	Adsorber Filter, Manual / Semi-auto drain	P3XFA14AGCN	18	16	-10	60	60	192	62	62	320
3/4	Adsorber Filter, Manual / Semi-auto drain	P3XFA16AGCN	18	16	-10	60	60	192	62	62	320

* flow with 6,3 bar inlet pressure and 0,2 pressure drop.

Technical Information

Fluid:	Compressed air	
Maximum inlet pressure:	16 bar	
Temperature range*:	-10°C to +60°C	
Typical flow at 6,3 bar inlet pressure and 0.2 bar pressure drop:	Adsorber	18 dm ³ /s
Manual / Semi-auto drain:	1/8" connection	
to close connection	0.8 bar	

* Air supply must be dry enough to avoid ice formation at temperatures below +2°C

Material Specification

Body:	High tech polymer
Sight glass:	Polypropylene
Filter cover:	ABS
Adsorber element:	Activated carbon
Top & bottom endcap:	Glass filled nylon
Support cylinders:	Grade 430 stainless steel
Support media:	100% spun polypropylene
Support sock:	Polyester needlefelt
Encapsulant:	Epoxy resin / Hardener
Seals:	Nitrile NBR
Drain:	Manual / Semi-auto Acetal

Dimensions (mm)

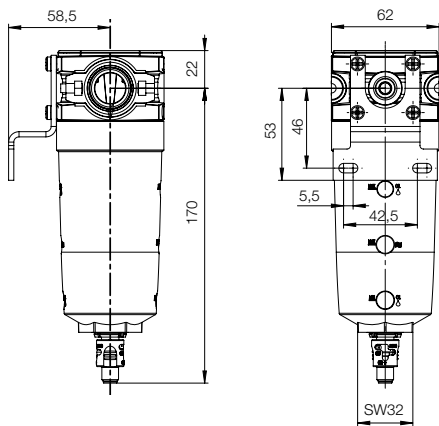

Service kits

Description	Order code
Adsorber element kit	P3XKA00ESA
Bowl kit with manual drain	P3XKA00BSC

Flow characteristics

(1/2) Adsorber Filter

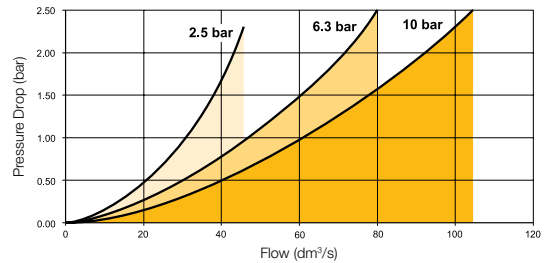

(3/4) Adsorber Filter

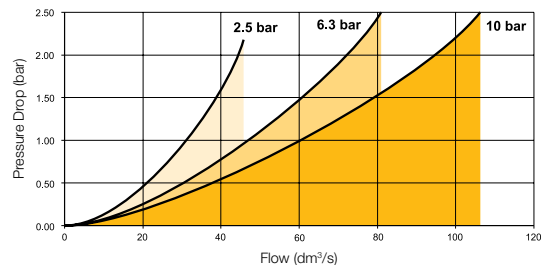

Regulator



Symbols

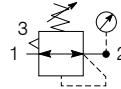

Self relieving regulator with gauge

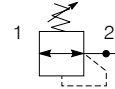

Non relieving regulator

- Integral 1/2 or 3/4 ports
- Secondary pressure ranges 8 & 16 bar
- Rolling diaphragm for extended life
- Secondary aspiration plus rolling diaphragm provides quick response and accurate pressure regulation.
- Optional tamperproof regulator, up to x 3 padlocks
- Relieving & Non-relieving types

Options:

P 3 X R A							N		
BSPP (G)	1	1/2	4	Relieving	B	Non rise - standard	N	0 - 8 bar No Gauge	N
NPT *	9	3/4	6	Non-relieving	N	Tamperproof - Lockable	A	0 - 16 bar No Gauge	H
								0 - 8 bar Gauge	G
								0 - 16 bar Gauge	J

* NPT ports on request
1/2" size only

Port size	Description	Order Code	Flow dm ³ /s *	Max bar	Min temp °C	Max temp °C	Height mm	Width mm	Depth mm	Weight g
1/2	8 bar relieving	P3XRA14BNNN	122	16	-10	60	150	62	62	360
1/2	8 bar relieving + pressure gauge	P3XRA14BNGN	122	16	-10	60	150	62	95	410
3/4	8 bar relieving	P3XRA16BNNN	134	16	-10	60	150	62	62	360
3/4	8 bar relieving + pressure gauge	P3XRA16BNGN	134	16	-10	60	150	62	95	410
1/2	8 bar relieving with tamperproof facility	P3XRA14BANN	122	16	-10	60	158	62	62	360
1/2	8 bar relieving with tamperproof facility + pressure gauge	P3XRA14BAGN	122	16	-10	60	158	62	95	410
3/4	8 bar relieving with tamperproof facility	P3XRA16BANN	134	16	-10	60	158	62	62	360
3/4	8 bar relieving with tamperproof facility + pressure gauge	P3XRA16BAGN	134	16	-10	60	158	62	95	410

* flow with 10 bar inlet pressure, 6,3 bar set pressure and 1 bar pressure drop.
Tamperproof regulator will require lock kit (on opposite page) to lock regulator.

Technical Information

Fluid:	Compressed air
Maximum inlet pressure:	16 bar
Temperature range*:	-10°C to +60°C
Typical flow with 10 bar inlet pressure, 6.3 bar set pressure and 1 bar pressure drop:	1/2" 122 dm ³ /s 3/4" 134 dm ³ /s
Gauge port (x 2):	1/4"

* Air supply must be dry enough to avoid ice formation at temperatures below +2°C

Material Specification

Body:	High tech polymer
Bonnet:	High tech polymer
Regulator cover:	ABS
Control Knob:	Polyamide
Valve:	Brass / Nitrile
Seals:	Nitrile NBR
Screws:	Steel / zinc plated

Dimensions (mm)

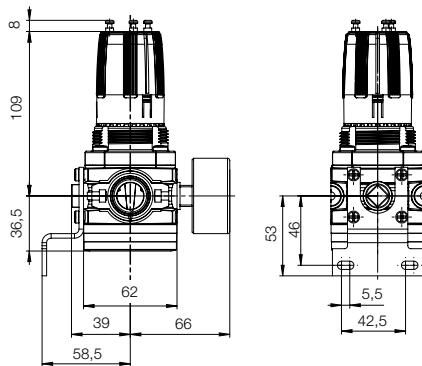

Service kits

Description	Order code
Wall bracket	P3XKA00MW
Panel mounting nut	P3XKA00MM
Key lock	P3XKA00AS
Diaphragm kit (relieving type)	P3XKA00RR
Diaphragm kit (non-relieving type)	P3XKA00RN

Lockable Tamperproof Kit (up to x 3 padlocks)

This facilitates the tamperproofing of the Regulator and Filter-Regulator units. (On request)



Order code	
1 Padlock each	P3XKA00AS

Flow characteristics

Regulation characteristics: (1/2)

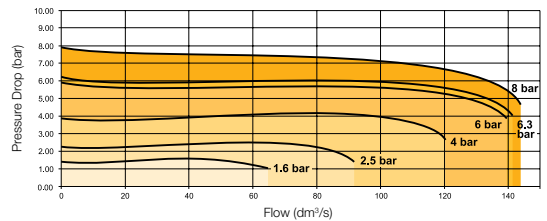

Regulation characteristics: (3/4)

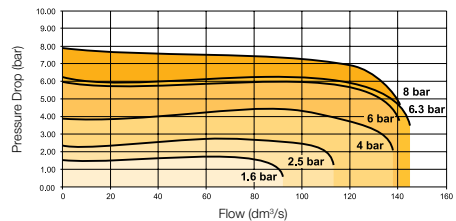

Filter-Regulator



Symbols

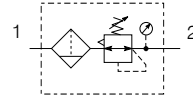

- Integral 1/2 or 3/4 ports
- High efficiency 5 micron element as standard
- Excellent water removal efficiency
- Secondary pressure ranges 8 and 16 bar
- Rolling diaphragm for extended life
- Secondary aspiration plus balanced poppet provides quick response and accurate pressure regulation.

Options:

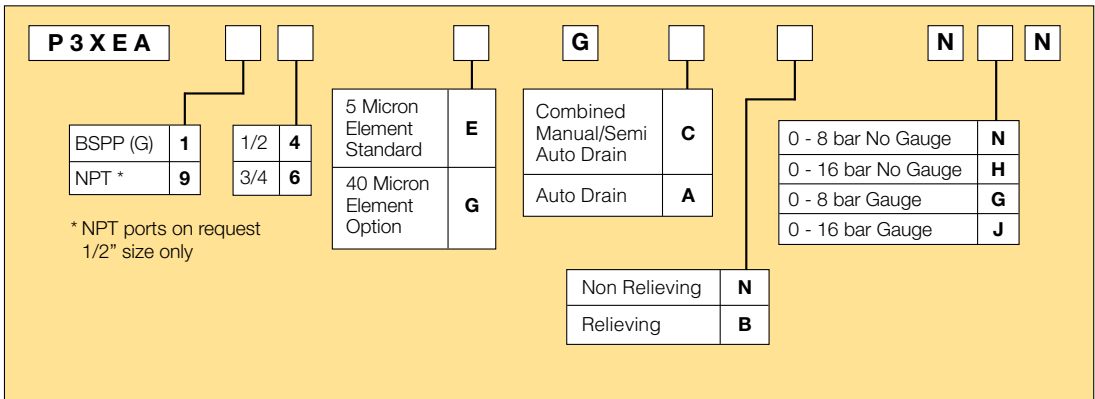

Port size	Description	Order Code	Flow dm ³ /s *	Max bar	Min temp °C	Max temp °C	Bowl capacity cm ³	Height mm	Width mm	Depth mm	Weight g
1/2	8 bar, relieving, Combined manual/semi auto drain	P3XEA14EGCBNNN	111	16	-10	60	60	280	62	62	500
1/2	8 bar relieving, auto drain	P3XEA14EGABNNN	111	16	-10	60	60	280	62	62	500
1/2	8 bar, relieving, gauge Combined manual/semi auto drain	P3XEA14EGCBNGN	111	16	-10	60	60	280	62	62	550
1/2	8 bar relieving, gauge, auto drain	P3XEA14EGABNGN	111	16	-10	60	60	280	62	62	550
3/4	8 bar, relieving, Combined manual/semi auto drain	P3XEA16EGCBNNN	113	16	-10	60	60	280	62	62	500
3/4	8 bar relieving, auto drain	P3XEA16EGABNNN	113	16	-10	60	60	280	62	62	500
3/4	8 bar, relieving, gauge Combined manual/semi auto drain	P3XEA16EGCBNGN	113	16	-10	60	60	280	62	62	550
3/4	8 bar relieving, gauge, auto drain	P3XEA16EGABNGN	113	16	-10	60	60	280	62	62	550

* flow with 10 bar inlet pressure, 6,3 bar set pressure and 1 bar pressure drop.

Technical Information

Fluid:	Compressed air
Maximum inlet pressure:	16 bar
Temperature range*:	-10°C to +60°C
Particle removal:	5 micron and 40 micron
Air quality:	Within ISO 8573-1 : 1991 Class 3 and 5 (particulates) Within ISO 8573-1 : 2001 Class 6 and 7 (particulates)
Typical flow with 10 bar inlet pressure 6,3 bar set pressure and 1 bar pressure drop 106 dm ³ /s	
Manual / Semi-auto drain: pressure to close drain	0.8 bar
Auto drain: bowl pressure to close drain Operating range manual override facility	0.8 bar 0.8 to 16 bar
Bowl sump capacity:	60 cm ³
Gauge ports (x 2):	1/4"

* Air supply must be dry enough to avoid ice formation at temperatures below +2°C

Material Specification

Body:	High tech polymer
Sight glass:	Polypropylene
Body cover:	ABS
Element:	Sintered P.E.
Seals:	Nitrile NBR
Drains:	Manual / Semi-auto: Acetal Automatic: PA / Brass
Bonnet:	High tech polymer
Control knob:	Polyamide
Valve:	Brass / Nitrile
Screws:	Steel/ zinc plated

Dimensions (mm)

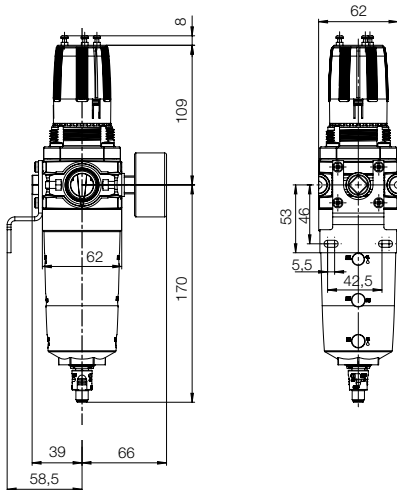

Service kits

Description	Order code
5 micron element kit	P3XKA00ESE
40 micron element kit	P3XKA00ESG
Bowl kit with combined manual/semi auto drain	P3XKA00BSC
Bowl kit with auto drain	P3XKA00BSA
Tamper-proof knob kit (keylock)	P3XKA00AS
Diaphragm kit (relieving type)	P3XKA00RR
Diaphragm kit (non-relieving type)	P3XKA00RN
Wall bracket kit	P3XKA00MW
Panel mount nut	P3XKA00MM

Flow characteristics

(1/2) 5 Micron Filter/Regulator

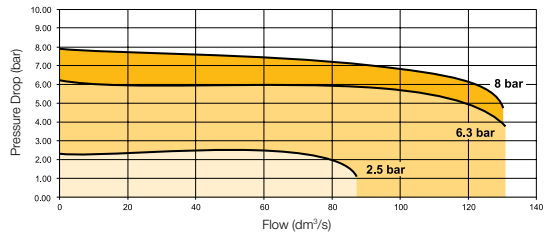

(3/4) 5 Micron Filter/Regulator

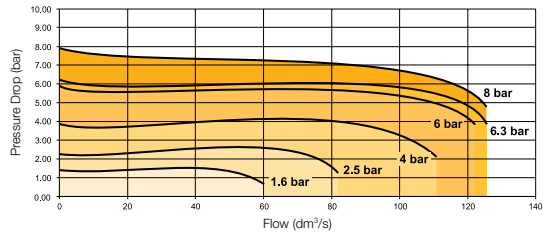

Lubricator



Symbols

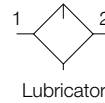

- Integral 1/2 or 3/4 ports
- Proportional oil delivery over a wide range of air flows.
- No adjustment necessary (self adjusting)
- Fill from top under system pressure

Options:

P 3 X L A				G N N												
* NPT ports on request 1/2" size only	<table border="1" style="margin: auto;"> <tr><td>BSPP (G)</td><td style="text-align: center;">1</td></tr> <tr><td>NPT *</td><td style="text-align: center;">9</td></tr> </table>	BSPP (G)	1	NPT *	9	<table border="1" style="margin: auto;"> <tr><td>1/2</td><td style="text-align: center;">4</td></tr> <tr><td>3/4</td><td style="text-align: center;">6</td></tr> </table>	1/2	4	3/4	6	<table border="1" style="margin: auto;"> <tr><td>5 mg/m³</td><td style="text-align: center;">S¹⁾</td></tr> <tr><td>50 mg/m³</td><td style="text-align: center;">P²⁾</td></tr> </table>	5 mg/m ³	S ¹⁾	50 mg/m ³	P ²⁾	
BSPP (G)	1															
NPT *	9															
1/2	4															
3/4	6															
5 mg/m ³	S ¹⁾															
50 mg/m ³	P ²⁾															

Port size	Description	Order Code	Flow dm ³ /s *	Max bar	Min temp °C	Max temp °C	Bowl capacity cm ³	Height mm	Width mm	Depth mm	Weight g
1/2	Oil mist, fill under pressure (50mg/m ³)	P3XLA14PGNN	78	16	-10	60	90	195	62	62	300
3/4	Oil mist, fill under pressure (50mg/m ³)	P3XLA16PGNN	78	16	-10	60	90	195	62	62	300
1/2	Oil mist, fill under pressure (5mg/m ³)	P3XLA14SGNN	78	16	-10	60	90	195	62	62	300
3/4	Oil mist, fill under pressure (5mg/m ³)	P3XLA16SGNN	78	16	-10	60	90	195	62	62	300

* Flow with 6,3 bar inlet pressure and 0,5 pressure drop.

¹⁾ Best for pre-lubricated pneumatic components (e.g. rodless cylinder, actuators, valves etc.)

²⁾ Best for components which require effective lubrication (e.g. vane driven pneumatic motors / air tools etc.)

Technical Information

Fluid:	Compressed air
Maximum inlet pressure:	16 bar
Temperature range*:	-10°C to +60°C

* Air supply must be dry enough to avoid ice formation at temperatures below +2° C
 Low flow start point (lubrication pick-up): at 6.3bar inlet pressure 7 dm³/s
 Typical flow with 6.3bar inlet pressure and 0.5 bar pressure drop: 78 dm³/s

Note : Fill lubricant from top only

Material Specification

Body:	High tech polymer
Bowl sight glass:	Polypropylene
Sight dome:	PA (Nylon)
Lubricator cover:	ABS
Seals:	Nitrile NBR

Dimensions (mm)

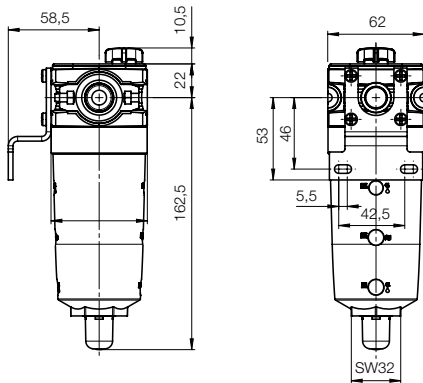

Flow characteristics

(1/2) Lubricator

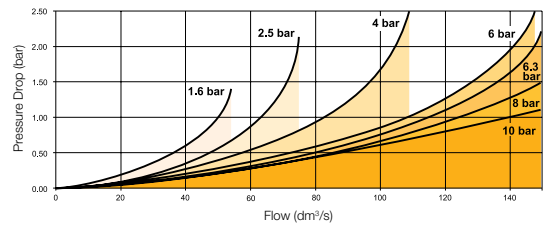

(3/4) Lubricator

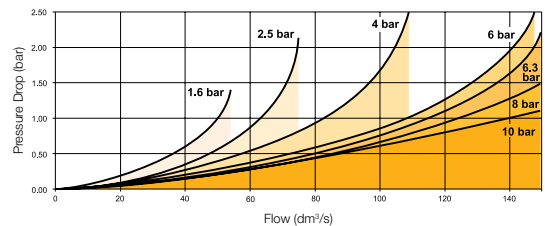

Service kits

Description	Order code
Bowl kit	P3XKA00BSN
Refill plug	P3XKA00PL
Oil VG15 - 100ml	P3XKA00PPA

Modular Slide Valve



Symbol

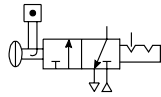

- Padlockable.
- When the inlet pressure is turned off the downstream vents through the exhaust port.

P3X Series Slide Valves provide shut off line pressure to prevent unauthorised adjustment.

Options:

P 3 X	VA			LSN
BSPP (G)	1	G1/2	4	
NPT *	9	G3/4	6	

* NPT ports on request (1/2" size only)

Technical Information

Operating Temperature:	-10°C to +60°C
Maximum Supply Pressure:	16 bar
Weight (g):	1/2 300g 3/4 300g

Material specification:

Body:	High tech polymer
Handle:	Polyamide
Seals:	Nitrile NBR
Exhaust muffler:	Sintered bronze

Dimensions (mm)

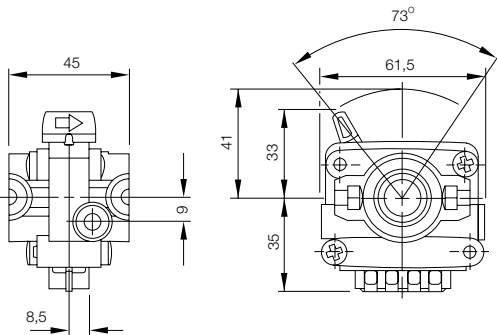

Modular Manifold



P3X Series Manifolds, provide up to 2 extra outlet ports, they may be assembled at any position in a combination e.g. before the lubricator to provide oil free take off or at the end of a combination to provide extra outlet ports.

Description	Order code BSPP	Order code NPT	Weight (g)
G1/2"	P3XMA1V0N	P3XMA9V0N	170

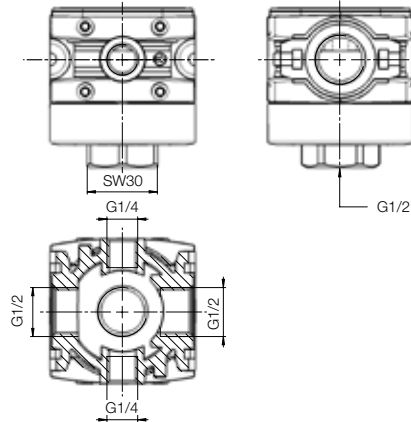

Inlet port	Bottom	Front and Back
1/2	1/2"	1/4"





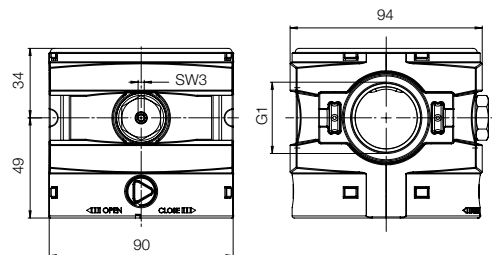

Material specification:

Body:	High tech polymer
Manifold Cover:	ABS

Dimensions (mm)



Accessories

Description	Connection	Weight (g)	Order code	
Panel mounting nut		10	P3XKA00MM	
Wall bracket kit		80	P3XKA00MW	
P3X connecting kit		10	P3XKA00CB	
Lubricator Oil	VG15 : ISO 3448 - 100ml	100	P3XKA00PPA	
Pressure gauge	0 to 10 bar 0 to 16 bar	1/4" 1/4"	KG8012 KG8013	
Connector O-ring kit	Qty: 5		P3XKA04CY	
Regulator & Filter/Regulator - Key Lock Kit		0.05	P3XKA00AS	



P3X Series Membrane Dryers

Advantages of the P3X Series Membrane Dryers

Dried compressed air is immediate



No electrical connection necessary

Suitable for hazardous areas



No CFC's/FC's

Compatible with the P3X series modular air preparation series



Low pressure drop

No moving parts

No drying medium required

Low purge air usage

Low operating costs



Dryer types with PDP reduction & flow values

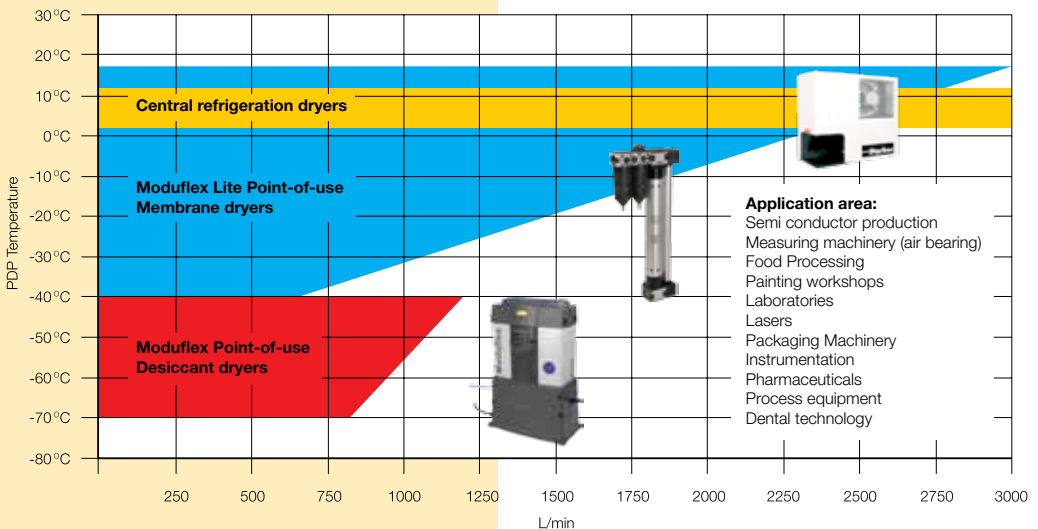

- Application area:**
- Semi conductor production
 - Measuring machinery (air bearing)
 - Food Processing
 - Painting workshops
 - Laboratories
 - Lasers
 - Packaging Machinery
 - Instrumentation
 - Pharmaceuticals
 - Process equipment
 - Dental technology

- Removes water vapour & lowers the PDP
- Compact design
- No electrical connections necessary
- Suitable for hazardous environments
- No moving parts
- Maintenance & wear free
- No change in air consumption
- Low pressure drop less than 0.1 bar
- Minimal purge air consumption
- Modular design - compatible with the P3X air prep series



Membrane dryer

Port size	Size	Description	Order Code
G1/2	10	Membrane dryer with return tube	P3XJA14CA1N
G1/2	15	Membrane dryer with return tube	P3XJA14CB1N
G1/2	20	Membrane dryer with return tube	P3XJA14CC1N
G1/2	25	Membrane dryer with return tube	P3XJA14CD1N
G1/2	35	Membrane dryer serial type	P3XJA14CE1N
G1/2	50	Membrane dryer serial type	P3XJA14CF1N



Note: For NPT threaded connections replace the 6th digit from 1 to 9 i.e. P3XJA94CA1N

Wall mounting bracket kit

Order Code	Description
P3XKA00MWD	Top & bottom wall mounting bracket

Note:

For optimum system performance and maintenance free conditions, Parker recommend the dryer is preceded with a 5 micron and 0.01 coalescer filter from the P3X series.

Complete Filter / Dryer System combinations available on request



F + Fc + MD



F + Fc + MD + R



F + Fc + MD + R + Fa

Technical Information

			Size 10	Size 15	Size 20	Size 25	Size 35	Size 50
Port size			G1/2	G1/2	G1/2	G1/2	G1/2	G1/2
Medium and Ambient temperature	ϑ_{min} °C	°C	+2	+2	+2	+2	+2	+2
	ϑ_{min} °C	°C	+60	+60	+60	+60	+60	+60
Weight (kg)			3.3	3.3	3.3	3.3	4.2	4.2
Operating pressure range	P_{min}	bar	5	5	5	5	5	5
Input	P_{max}	bar	16	16	16	16	16	16
Maximum flow	Q_{max}	l/min	560	840	1120	1400	1960	2800
		m ³ /h	33.6	50.4	67.2	84	117.5	168
Nominal flow	Q_{max}	l/min	167	250	333	417	583	833
		m ³ /h	10	15	20	25	35	50
Purging air requirement	%		ca. 10	ca. 10	ca. 10	ca. 10	ca. 10	ca. 10
Pressured drop	Δp	bar	0.02-0.05	0.02-0.05	0.02-0.05	0.02-0.05	0.06	0.12

**P3XJA14CA1N
P3XJA14CB1N
P3XJA14CC1N
P3XJA14CD1N**

**P3XJA14CE1N
P3XJA14CF1N**

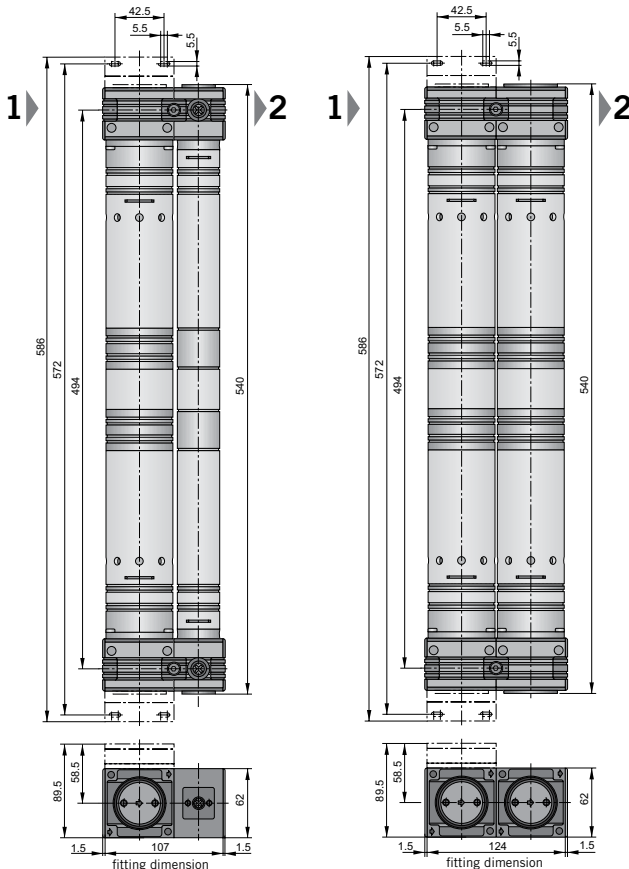

- Compact
- Immediate dry air delivery
- No electric power supply required
- Minimal purge air consumption
- Low pressure drop
- No change in air composition

Mounting Instructions

Recommended mounting sequence

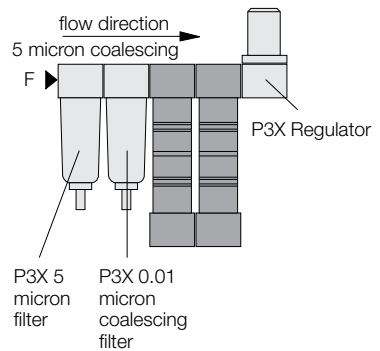

Dimensions in mm

Selection Criteria

To correctly select the dryer best suited for your application, the following information is required to ensure optimum performance and trouble free operation.

- Maximum inlet pressure dew point (°C)
- Outlet PDP (°C)
- Working pressure (bar)
- Maximum inlet flow rate (m³/h)

Conversion factor for calculation of corrected flow rate

Operating pressure range p (bar)	5	6	7	8	9	10	11	12	13	14	15	16
Conversion factor f _p	0.57	0.78	1.0	1.21	1.42	1.64	1.85	2.06	2.28	2.49	2.70	2.92

Working Example:

Selecting a dryer with an inlet pressure dew point of 35°C, a PDP reduction of 35K with a working / operating pressure of 6 bar and an inlet flow of 11 m³/h.

Step 1

From the correction factor table select the required pressure (6 bar) and read below the corrected factor value (0.78)

Step 2

To adjust the flow for your application, divide the required flow by the 0.78 correction factor

$$\text{Sizing capacity} = \frac{\text{Actual flow}}{\text{Correction factor}} = \frac{11 \text{ m}^3/\text{h}}{0.78} = 14.1 \text{ m}^3/\text{h}$$

Step 3

Plot the values on the selection graph (below). Where the dew point reduction value of 35K intersects with the corrected flow value of 14.1 m³/h, select the dryer flow curve which is equal or above the intersection point. For example: the optimum dryer would be

size 25 (P3XJA14CD1N)

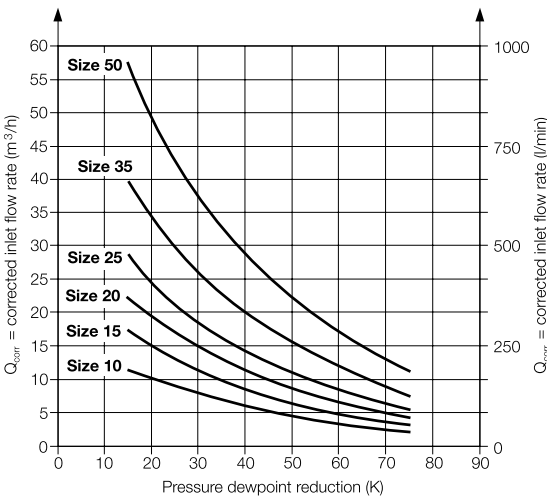

Membrane dryers

P3X Series - G1/2

Flow rate in relation to pressure dewpoint reduction and inlet pressure.

P3XJA14CA1N (Size 10)

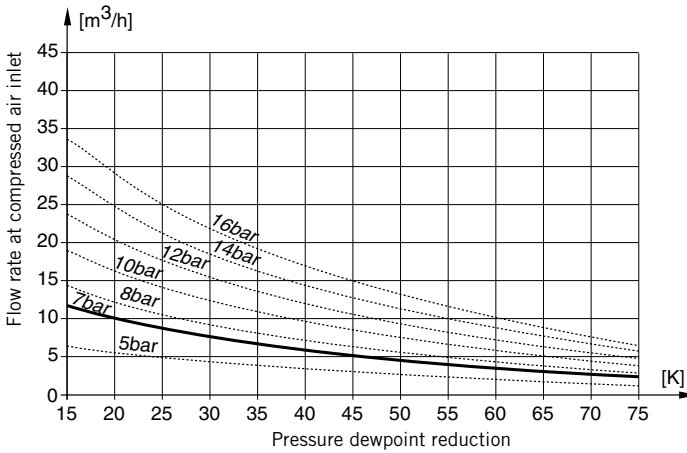

P3XJA14CB1N (Size 15)

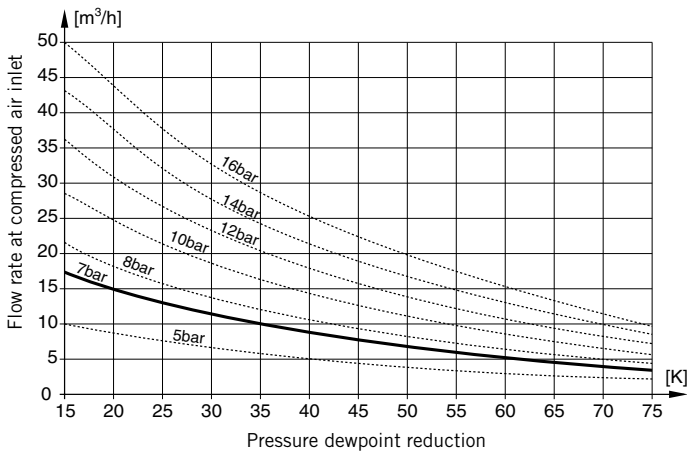

Membrane dryers

P3X Series - G1/2

Flow rate in relation to pressure dewpoint reduction and inlet pressure.

P3XJA14CC1N (Size 20)

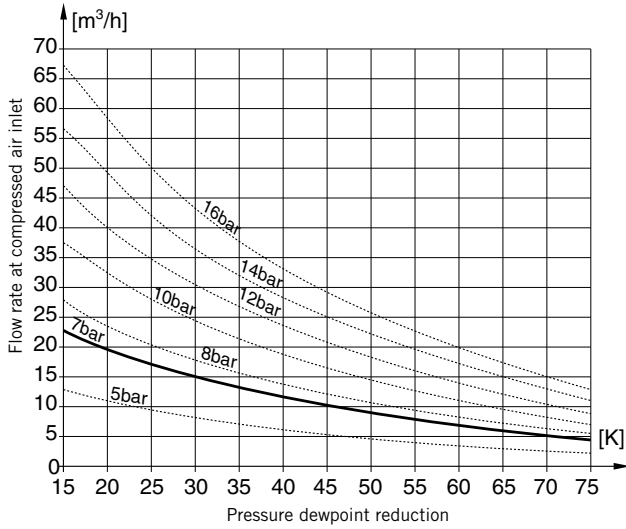

P3XJA14CD1N (Size 25)

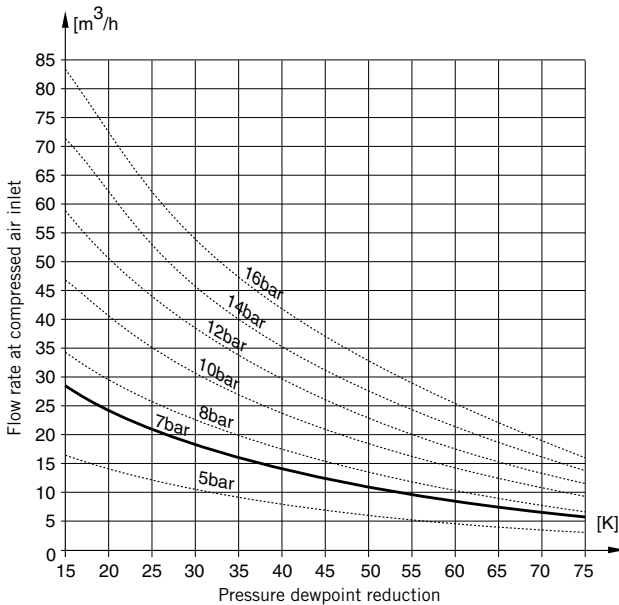

Membrane dryers

P3X Series - G1/2

Flow rate in relation to pressure
 dewpoint reduction and inlet
 pressure.

P3XJA14CE1N (Size 35)

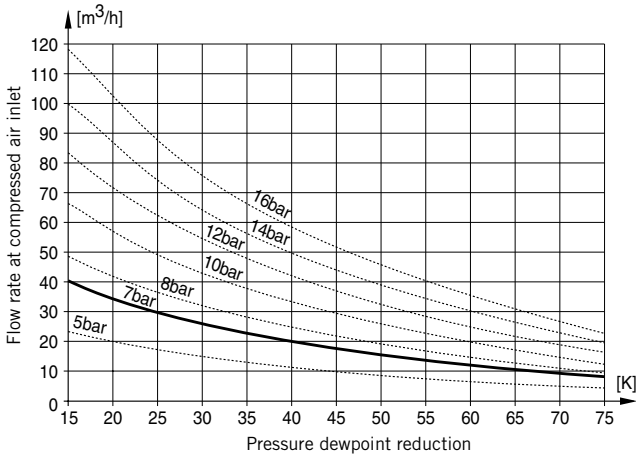

P3XJA14CF1N (Size 50)

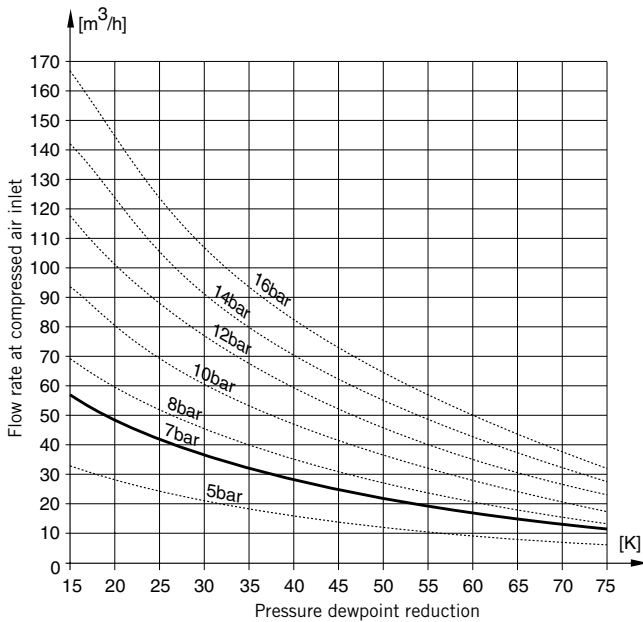



P3Y Series Air Preparation System

3/4" & 1" Body Ported

Recommended Wall Mounting Configurations

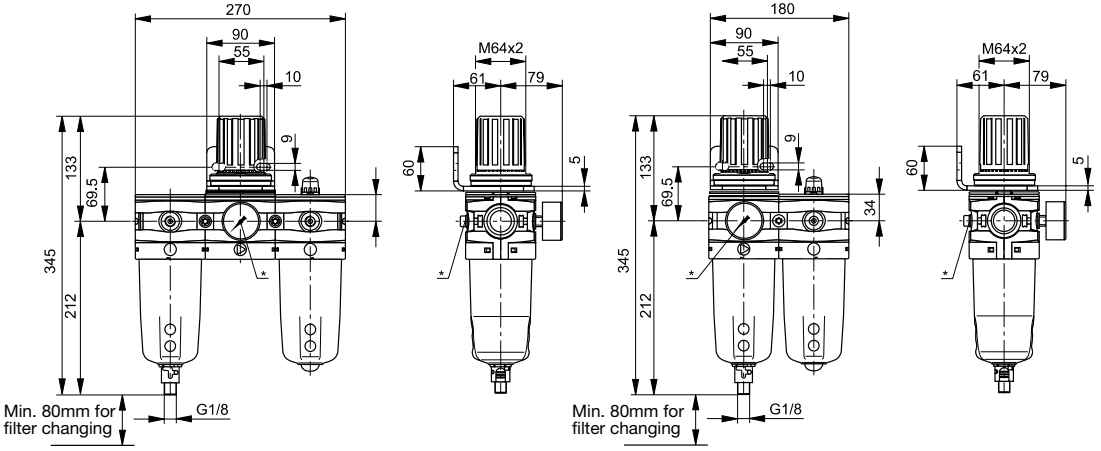

* Gauge port 1/4"

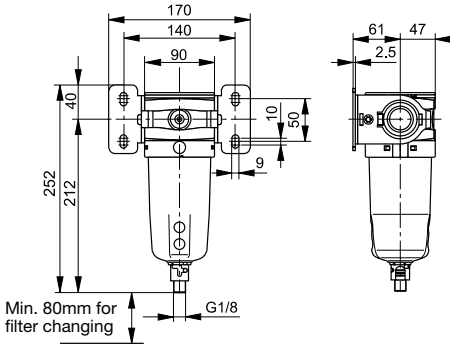

Popular Combinations

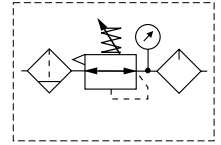

Filter + Regulator + Lubricator Combinations
40 micron element, 12 bar Regulator + Gauge and Wall Mounting Bracket

Port size	Combined Manual/Semi-Auto Drain	Flow dm ³ /s	Weight (kg)	Auto Drain	Flow dm ³ /s	Weight (kg)
G ³ / ₄	P3YCB16SGCNFLNF	91	3.3	P3YCB16SGANFLNF	91	3.3
G1	P3YCB18SGCNFLNF	174	3.3	P3YCB18SGANFLNF	174	3.3

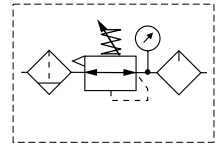

Filter/Regulator + Lubricator Combinations
40 micron element, 12 bar Regulator + Gauge and Wall Mounting Bracket

Port size	Combined Manual/Semi-Auto Drain	Flow dm ³ /s	Weight (kg)	Auto Drain	Flow dm ³ /s	Weight (kg)
G ³ / ₄	P3YCA16SGCNFLNF	101	2.8	P3YCA16SGANFLNF	101	2.8
G1	P3YCA18SGCNFLNF	168	2.8	P3YCA18SGANFLNF	168	2.8

* Flow measured with 10 bar inlet pressure, 6.3 bar set pressure, 1 bar pressure drop.

Options:

P 3 Y	C				SG		N	LNF	
Filter/Regulator + Lub	A	BSPP (G)	1	3/4	6	Combined Manual/Semi Auto Drain	C	0 - 12 bar with gauge	F
Filter + Regulator + Lub	B	NPT	9	1	8	Auto Drain	A	0 - 16 bar with gauge	J

Filter



Symbols

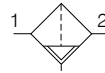

Manual / Semi auto drain

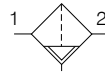

Auto drain

- Integral 3/4 or 1" ports (BSPP & NPT)
- High efficiency particulate element as standard
- Excellent water removal efficiency
- Robust but lightweight aluminium construction

Options:

P 3 Y F A													N
BSPP (G)	1	3/4	6	40 Micron Element Standard	G	Combined Manual/Semi Auto Drain		SC					
NPT	9	1"	8	5 Micron Element Optional	E	Auto Drain		SA					

Port size	Description	Order Code	Flow dm ³ /s*	Max bar	Min temp °C	Max temp °C	Bowl capacity cm ³	Height mm	Width mm	Depth mm	Weight kg
3/4	Combined manual/semi auto drain	P3YFA16GSCN	116	17.5	-10	60	130	244	90	94	0.9
3/4	Auto drain	P3YFA16GSAN	116	17.5	-10	60	130	244	90	94	0.9
1"	Combined manual/semi auto drain	P3YFA18GSCN	119	17.5	-10	60	130	244	90	94	0.9
1"	Auto drain	P3YFA18GSAN	119	17.5	-10	60	130	244	90	94	0.9

* flow with 6,3 bar inlet pressure and 0,5 pressure drop.

Technical Information

Fluid:	Compressed air
Maximum inlet pressure*:	17.5 bar
Temperature range*:	-10°C to +60°C
Particle removal:	5 & 40 micron
Air quality:	Within ISO 8573-1 : 1991 Class 3 and 5 (particulates) Within ISO 8573-1 : 2001 Class 6 and 7 (particulates)
Typical flow with 40µm element 6,3 bar inlet pressure and 0.5 bar pressure drop:	119 dm ³ /s
Manual/Semi-auto drain:	Closed at 0,8 bar G1/8 thread
Auto drain: bowl pressure to close drain Operating range manual override facility (depress pin)	0.8 bar 0.8 to 17.5 bar Ø 10mm brass connection
Bowl sump capacity:	130 cm ³

* Air supply must be dry enough to avoid ice formation at temperatures below +2°C

Material Specification

Body:	Aluminium
Sight glass:	Polypropylene
Body cover:	ABS
Element:	Sintered P.E.
Seals:	Nitrile NBR
Drains:	Manual / Semi-auto: Acetal Automatic: PA / Brass connection

Dimensions (mm)

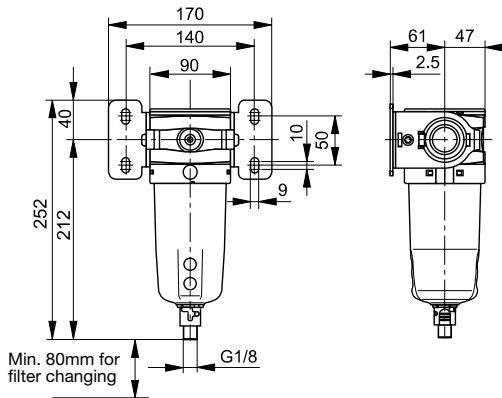

Service kits

Description	Order code
5 micron element kit	P3YKA00ESE
40 micron element kit	P3YKA00ESG
Bowl kit with combined manual/semi auto drain	P3YKA00BSC
Bowl kit with auto drain	P3YKA00BSA

Flow characteristics

(3/4) 40 Micron Filter

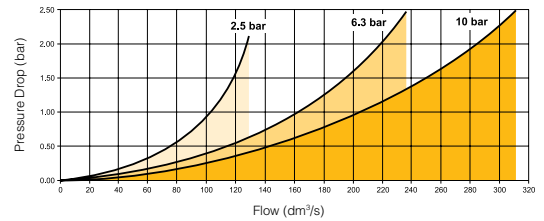

(1") 40 Micron Filter

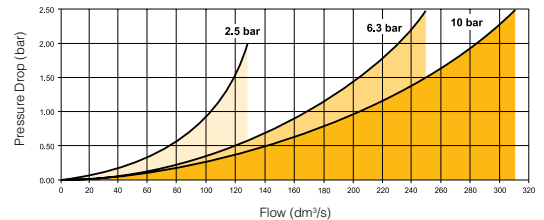

Dust Filter



- Extended dust filter element provides greater filtration surface area.
- Integral 3/4 or 1" ports (BSPP & NPT)
- Removes dust particles
- Dust free air for critical applications, such as air gauging, pneumatic instrumentation and control

Note: To optimise the life of the dust 1µm element, it is advisable to install a P3YFA pre-filter with a 5 or 40 micron element upstream of the coalescing filter.

Options:

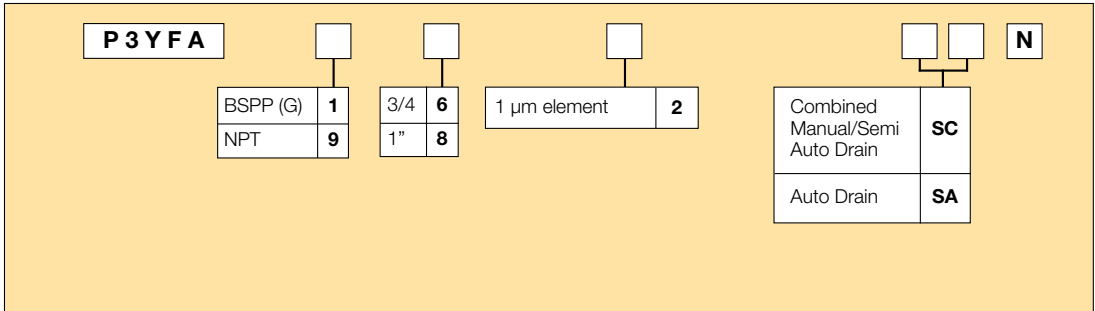

Port size	Description	Order Code	Flow dm ³ /s *	Max bar	Min temp °C	Max temp °C	Bowl capacity cm ³	Height mm	Width mm	Depth mm	Weight kg
3/4	Dust Filter 1µm, Combined manual/semi auto drain	P3YFA162SCN	137	17.5	-10	60	130	360	90	94	1.6
3/4	Dust Filter 1µm, auto drain	P3YFA162SAN	137	17.5	-10	60	130	360	90	94	1.6
1"	Dust Filter 1µm, Combined manual/semi auto drain	P3YFA182SCN	145	17.5	-10	60	130	360	90	94	1.6
1"	Dust Filter 1µm, auto drain	P3YFA182SAN	145	17.5	-10	60	130	360	90	94	1.6

* flow with 6,3 bar inlet pressure and 0,5 pressure drop

Technical Information

Fluid:	Compressed air
Maximum inlet pressure*:	17.5 bar
Temperature range*:	-10°C to +60°C
Typical flow element @ 6,3 bar inlet pressure and 5 bar pressure drop:	145 dm ³ /s
Manual/Semi-auto drain:	Bowl pressure to close drain 0.8 bar G1/8" thread
Auto drain:	bowl pressure to close drain 0.8 bar Operating range 0.8 to 17.5 bar manual override facility (depress pin) Ø 10mm brass connection
Bowl sump capacity:	130 cm ³

* Air supply must be dry enough to avoid ice formation at temperatures below +2°C

Material Specification

Body:	Aluminium
Sight glass:	Polypropylene
Filter cover:	ABS
Seals:	Nitrile NBR
Drains:	Manual / Semi-auto: Acetal Automatic: PA / Brass connection
Coalescing element:	Borosilicate & Nano fibres
Top & bottom end cap:	Aluminium
Support cylinders:	Grade 430 stainless steel
Support media:	Polypropylene
Ensupulate:	Epoxy resin / Hardener

Dimensions (mm)

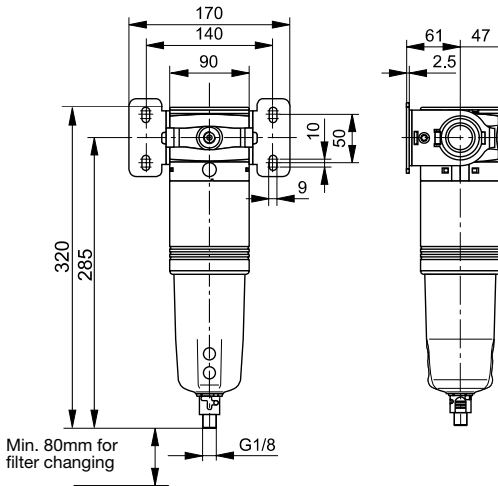

Flow characteristics

(1") 1µm Dust Filter Saturated

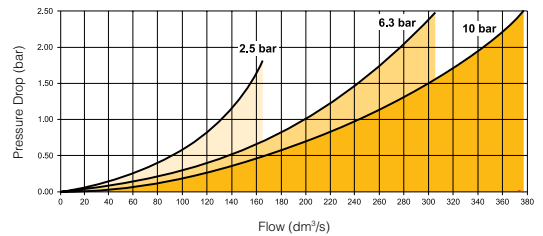

Service kits

Description	Order code
1 micron coalescing element kit	P3YKA00ES9
Bowl kit with combined manual/semi auto drain	P3YKA00BSC
Bowl kit with auto drain	P3YKA00BSA

Coalescing Filter



- Extended high efficiency filter element provides greater filtration surface area.
- Integral 3/4 or 1" ports (BSPP & NPT)
- Removes liquid aerosols and sub micron particles
- Oil free air for critical applications, such as air gauging, pneumatic instrumentation and control

Note: To optimise the life of the coalescing element, it is advisable to install a P3YFA pre-filter with a 5 micron element upstream of the coalescing filter.

Options:

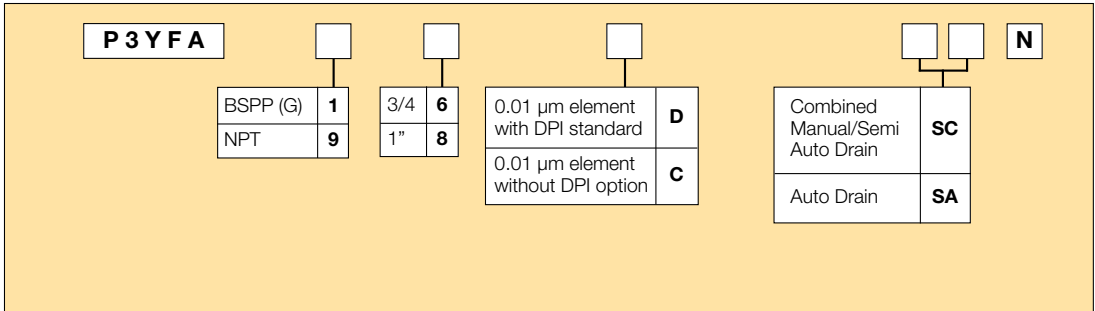

Port size	Description	Order Code	Flow dm ³ /s *	Max bar	Min temp °C	Max temp °C	Bowl capacity cm ³	Height mm	Width mm	Depth mm	Weight kg
3/4	Coalescing Filter 0.01µm, Combined manual/semi auto drain	P3YFA16DSCN	49	17.5	-10	60	130	340	90	94	1.6
3/4	Coalescing Filter 0.01µm, auto drain	P3YFA16DSAN	49	17.5	-10	60	130	340	90	94	1.6
1"	Coalescing Filter 0.01µm, Combined manual/semi auto drain	P3YFA18DSCN	59	17.5	-10	60	130	340	90	94	1.6
1"	Coalescing Filter 0.01µm, auto drain	P3YFA18DSAN	59	17.5	-10	60	130	340	90	94	1.6

* flow with 6,3 bar inlet pressure and 0,2 pressure drop

Technical Information

Fluid:	Compressed air
Maximum inlet pressure*:	17.5 bar
Temperature range*:	-10°C to +60°C
Media specifications:	
Coalescing efficiency	(0.3 to 0.6 micron particles): 99.97%
Max. oil carryover (PPM w/w):	0.008 mg/m ³
Typical flow element @	
6,3 bar inlet pressure	Dry element
and 0.2 bar pressure drop:	0.01µm @ 59dm ³ /s
Manual/Semi-auto drain:	Bowl pressure to close drain 0.8 bar G1/8" thread
Auto drain:	
bowl pressure to close drain	0.8 bar
Operating range	0.8 to 17.5 bar
manual override facility (depress pin)	Ø 10mm brass connection
Bowl sump capacity:	130 cm ³

* Air supply must be dry enough to avoid ice formation at temperatures below +2°C

Material Specification

Body:	Aluminium
Sight glass:	Polypropylene
Filter cover:	ABS
Coalescing element:	Borosilicate & Nano fibres
Top & bottom end cap:	Aluminium
Support cylinders:	Grade 430 stainless steel
Support media:	Polypropylene
Anti re-entrainment barrier:	Polyester
Enapsulate:	Epoxy resin / Hardener
Seals:	Nitrile NBR
Drains:	Manual / Semi-auto: Acetal
	Automatic: PA / Brass connection
Differential pressure indicator materials:	
Body:	Acetal
Internal parts:	Acetal
Spring:	Stainless steel
Seals:	Nitrile NBR
Support plate	ABS
Screws	Steel / zinc plated

Dimensions (mm)

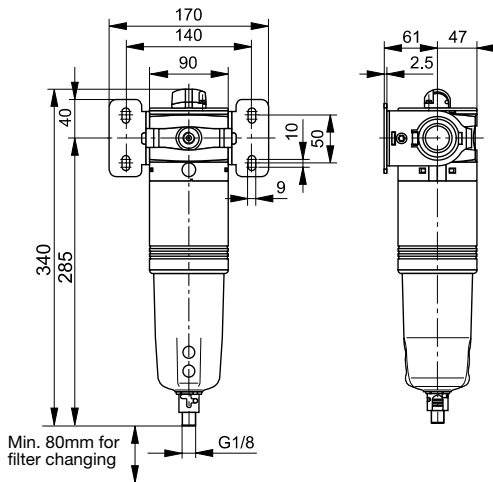

Service kits

Description	Order code
0.01 micron coalescing element kit	P3YKA00ESC
Bowl kit with combined manual/semi auto drain	P3YKA00BSC
Bowl kit with auto drain	P3YKA00BSA
Differential pressure indicator kit	P3YKA00RQ

Flow characteristics

(3/4) 0.01µm Coalescing Filter Saturated

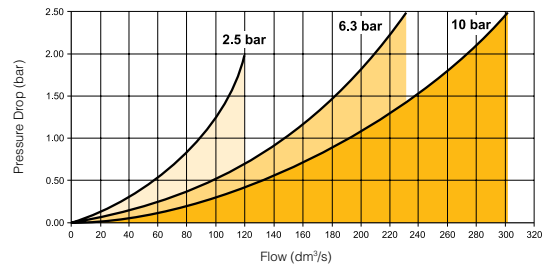

(1") 0.01µm Coalescing Filter Saturated

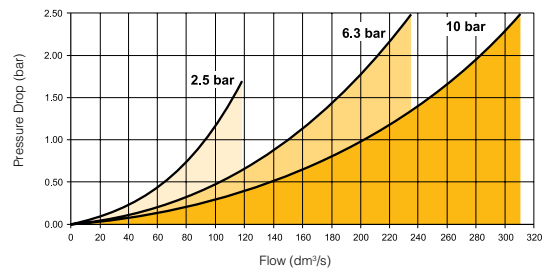

Adsorber Filter



- Integral 3/4 or 1" ports (BSPP & NPT)
- Adsorber activated carbon element removes oil vapours and most hydrocarbons

Note: To optimise the life of the adsorber element, it is advisable to install a P3Y coalescing 0.01 µm filter upstream of the adsorber filter.

Options:

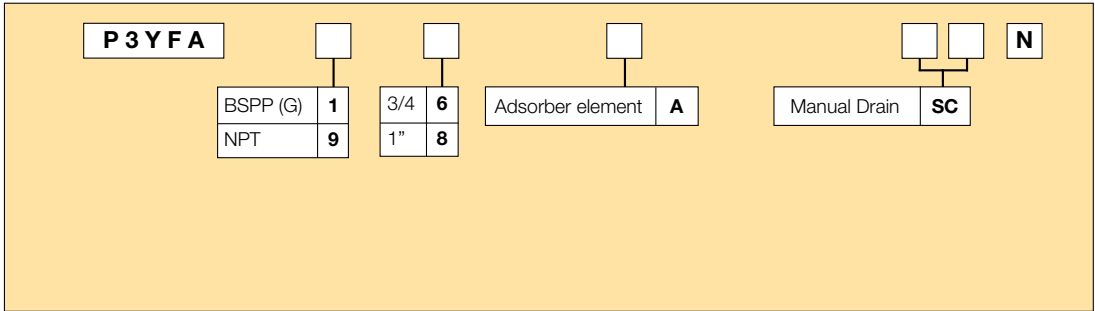

Port size	Description	Order Code	Flow dm ³ /s *	Max bar	Min temp °C	Max temp °C	Bowl capacity cm ³	Height mm	Width mm	Depth mm	Weight kg
3/4	Adsorber Filter, Manual drain	P3YFA16ASCN	47	17.5	-10	60	130	340	90	94	1.5
1"	Adsorber Filter, Manual drain	P3YFA18ASCN	50	17.5	-10	60	130	340	90	94	1.5

* flow with 6,3 bar inlet pressure and 0,2 pressure drop

Technical Information

Fluid:	Compressed air	
Maximum inlet pressure*:	17.5 bar	
Temperature range*:	-10°C to +60°C	
Media specifications:		
Max. oil carryover (PPM w/w):	0.008 mg/m ³	
Typical flow at 6,3 bar inlet pressure and 0.2 bar pressure drop:	1" Adsorber	50 dm ³ /s
Manual drain / Semi-auto drain:	G1/8" thread	
Bowl sump capacity:	130 cm ³	

* Air supply must be dry enough to avoid ice formation at temperatures below +2°C

Material Specification

Body:	Aluminium
Sight glass:	Polypropylene
Filter cover:	ABS
Adsorber element:	Activated carbon
Top & bottom endcap:	Glass filled nylon
Seals:	Nitrile NBR
Bayonet support:	Nylon
Drain: Manual / Semi-auto:	Acetal

Dimensions (mm)

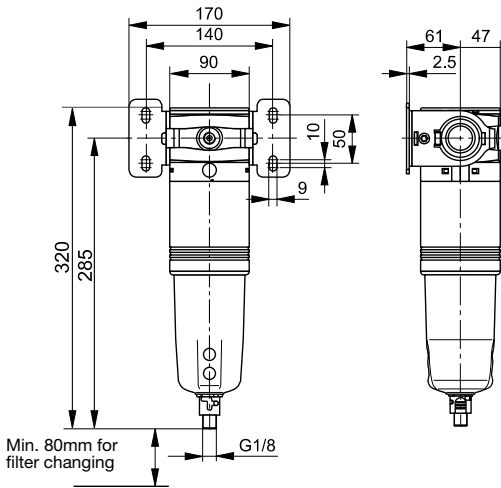

Service kits

Description	Order code
Adsorber element kit	P3YKA00ESA
Bowl kit with manual / semi-auto drain	P3YKA00BSC

Flow characteristics

(3/4) Adsorber Filter

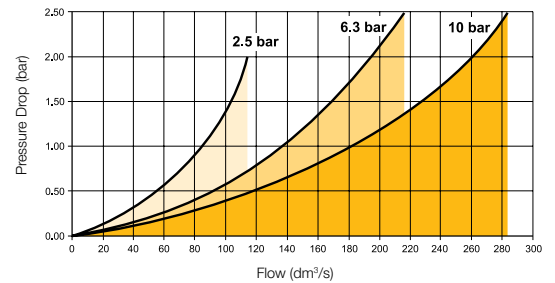

(1") Adsorber Filter

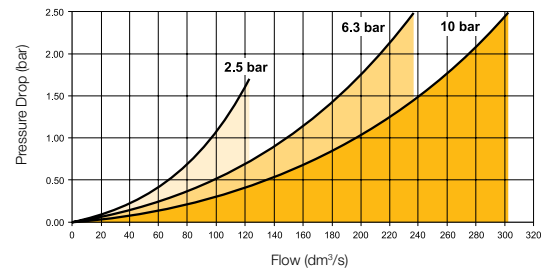

Regulator



Symbols

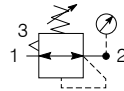

Self relieving regulator with gauge

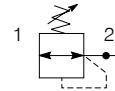

Non relieving regulator

- Integral 3/4 or 1" ports (BSPP & NPT)
- Robust but lightweight aluminium construction
- Secondary pressure ranges 12 & 16 bar
- Rolling diaphragm for extended life
- Secondary aspiration plus rolling diaphragm provides quick response and accurate pressure regulation.
- Optional tamperproof regulator padlock
- Relieving & Non-relieving types

Options:

P3YRA						N			
BSPP (G)	1	3/4	6	Relieving	B	Standard	N	0 - 12 bar No Gauge	E
NPT	9	1"	8	Non-relieving	N	Lockable type	A	0 - 16 bar No Gauge	H
								0 - 12 bar Gauge	F
								0 - 16 bar Gauge	J

Port size	Description	Order Code	Flow dm ³ /s *	Max bar	Min temp °C	Max temp °C	Height mm	Width mm	Depth mm	Weight kg
3/4	12 bar relieving	P3YRA16BNEN	155	17.5	-10	60	182	90	94	1.08
3/4	12 bar relieving + pressure gauge	P3YRA16BNFN	155	17.5	-10	60	182	90	94	1.13
1"	12 bar relieving	P3YRA18BNEN	321	17.5	-10	60	182	90	94	1.08
1"	12 bar relieving + pressure gauge	P3YRA18BNFN	321	17.5	-10	60	182	90	94	1.19
3/4	12 bar relieving, lockable	P3YRA16BAEN	155	17.5	-10	60	182	90	94	1.08
3/4	12 bar relieving lockable, + pressure gauge	P3YRA16BAFN	155	17.5	-10	60	182	90	94	1.13
1"	12 bar relieving, lockable	P3YRA18BAEN	321	17.5	-10	60	182	90	94	1.08
1"	12 bar relieving, lockable + pressure gauge	P3YRA18BAFN	321	17.5	-10	60	182	90	94	1.19

* Flow with 10 bar inlet pressure, 6,3 bar set pressure and 1 bar pressure drop.

Lockable regulators will require key lock kit (opposite page).

Technical Information

Fluid:	Compressed air
Maximum inlet pressure*:	17.5 bar
Temperature range*:	-10°C to +60°C
Typical flow with 10 bar inlet pressure, 6.3 bar set pressure and 1 bar pressure drop:	1" size 321 dm ³ /s
Gauge port (x 2):	1/4"

* Air supply must be dry enough to avoid ice formation at temperatures below +2°C

Material Specification

Body:	Aluminium
Bonnet:	Glass filled polyamide
Regulator cover:	ABS
Control Knob:	Glass filled polyamide
Valve:	Brass / NBR
Seals:	Nitrile NBR
Screws:	Steel / zinc plated

Dimensions (mm)

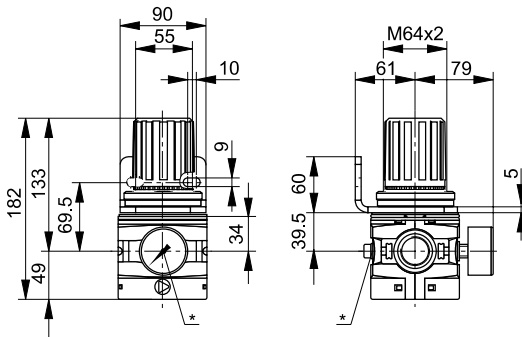

* 1/4" gauge port

Service kits

Description	Order code
Angle bracket + metal lock ring	P3YKA00MS
Panel mounting nut	P3YKA00MM
Key lock	P3XKA00AS
Diaphragm kit (relieving type)	P3YKA00RR
Diaphragm kit (non-relieving type)	P3YKA00RN

Key Lock Kit

This facilitates the tamperproofing of the lockable Regulators and Filter-Regulator units on request.



Order code

P3XKA00AS

Flow characteristics

Regulation characteristics: (3/4")

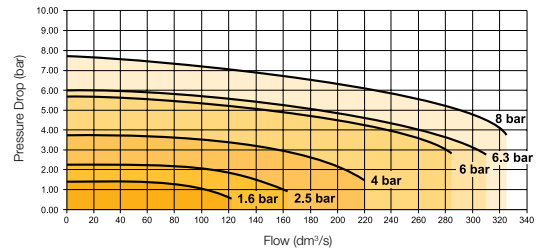

Regulation characteristics: (1")

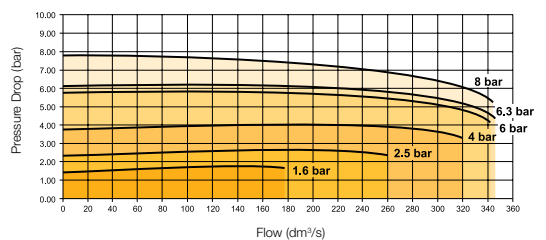

Filter-Regulator



Symbols

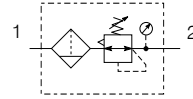

- Integral 3/4 or 1" ports (BSPP or NPT)
- High efficiency element as standard
- Excellent water removal efficiency
- Robust but lightweight aluminium construction
- Secondary pressure ranges 12 and 16 bar
- Rolling diaphragm for extended life
- Secondary aspiration plus balanced poppet provides quick response and accurate pressure regulation.

Options:

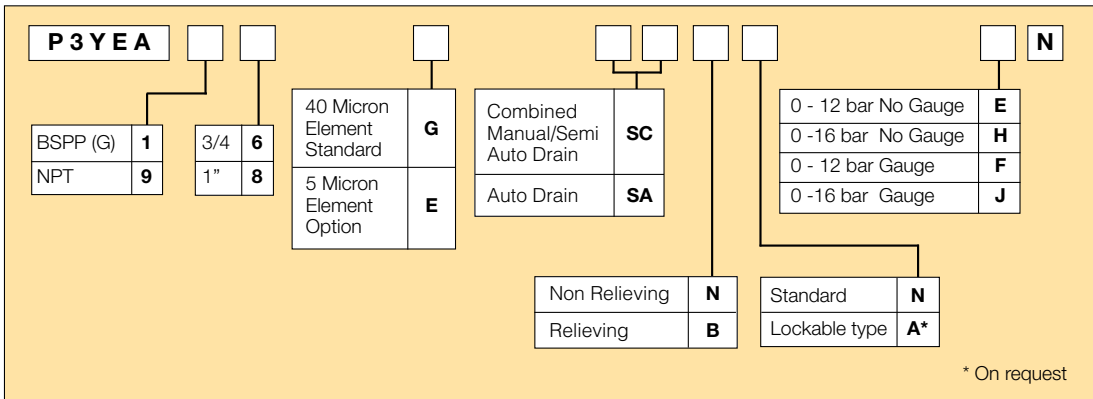

Port size	Description	Order Code	Flow dm ³ /s *	Max bar	Min temp °C	Max temp °C	Bowl capacity cm ³	Height mm	Width mm	Depth mm	Weight kg
3/4	12 bar, relieving, Combined manual/semi auto drain	P3YEA16GSCBNEN	190	17.5	-10	60	130	345	90	94	1.5
3/4	12 bar relieving, auto drain	P3YEA16GSABNEN	190	17.5	-10	60	130	345	90	94	1.5
3/4	12 bar, relieving, gauge Combined manual/semi auto drain	P3YEA16GSCBNFN	190	17.5	-10	60	130	345	90	94	1.5
3/4	12 bar relieving, gauge, auto drain	P3YEA16GSABNFN	190	17.5	-10	60	130	345	90	94	1.5
1"	12 bar, relieving, Combined manual/semi auto drain	P3YEA18GSCBNEN	237	17.5	-10	60	130	345	90	94	1.5
1"	12 bar relieving, auto drain	P3YEA18GSABNEN	237	17.5	-10	60	130	345	90	94	1.5
1"	12 bar, relieving, gauge Combined manual/semi auto drain	P3YEA18GSCBNFN	237	17.5	-10	60	130	345	90	94	1.5
1"	12 bar relieving, gauge, auto drain	P3YEA18GSABNFN	237	17.5	-10	60	130	345	90	94	1.5

* flow with 10 bar inlet pressure, 6,3 bar set pressure and 1 bar pressure drop.

Technical Information

Fluid:	Compressed air
Maximum inlet pressure*:	17.5 bar
Temperature range*:	-10°C to +60°C
Particle removal:	5 micron and 40 micron
Air quality:	Within ISO 8573-1 : 1991 Class 3 and 5 (particulates) Within ISO 8573-1 : 2001 Class 6 and 7 (particulates)
Typical flow with 10 bar inlet pressure 6,3 bar set pressure and 1 bar pressure drop 1" size	237 dm ³ /s
Manual/Semi-auto drain:	0,8 bar bowl pressure to close drain G1/8" thread
Auto drain:	bowl pressure to close drain 0.8 bar Operating range 0.8 to 17.5 bar manual override facility (depress pin) Ø 10mm brass connection
Bowl sump capacity:	130 cm ³
Gauge ports (x 2):	1/4"

* Air supply must be dry enough to avoid ice formation at temperatures below +2°C

Material Specification

Body:	Aluminium
Sight glass:	Polypropylene
Body cover:	ABS
Element:	Sintered polypropylene
Seals:	Nitrile NBR
Drains:	Manual / Semi-auto: Acetal Automatic: PA / Brass connection
Bonnet:	Glass filled polyamide
Control knob:	Glass filled polyamide
Valve:	Brass / NBR
Screws:	Steel/ zinc plated

Dimensions (mm)

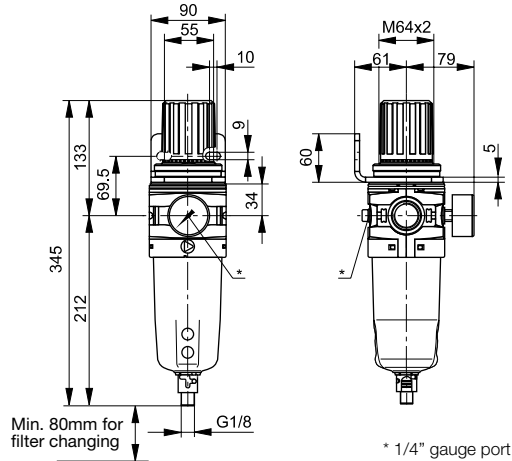

Service kits

Description	Order code
5 micron element kit	P3YKA00ESE
40 micron element kit	P3YKA00ESG
Bowl kit with combined manual/semi auto drain	P3YKA00BSC
Bowl kit with auto drain	P3YKA00BSA
Key Lock Kit	P3XKA00AS
Diaphragm kit (relieving type)	P3YKA00RR
Diaphragm kit (non-relieving type)	P3YKA00RN
Angle bracket + metal lock ring	P3YKA00MS
Panel mount nut	P3YKA00MM

Flow characteristics

(3/4) 40 Micron Filter/Regulator

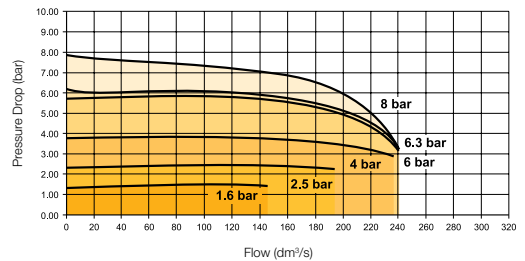

(1") 40 Micron Filter/Regulator

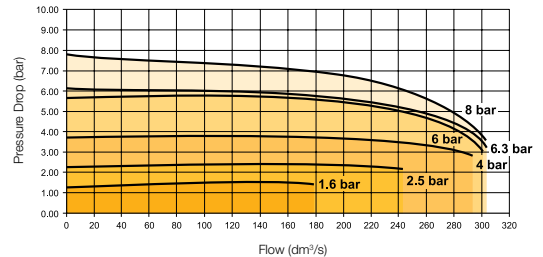

Lubricator



Symbols

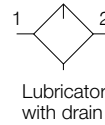

- Integral 3/4 or 1" ports (BSPP & NPT)
- Robust but lightweight aluminium construction
- Proportional oil delivery over a wide range of air flows.
- Possible to fill under system pressure eliminating down time
- Large oil reservoir

Options:

P 3 Y L A			L S N N
	1	6	
	9	8	

Port size	Description	Order Code	Flow dm ³ /s *	Max bar	Min temp °C	Max temp °C	Bowl capacity cm ³	Height mm	Width mm	Depth mm	Weight kg
3/4	Oil mist, fill under pressure	P3YLA16LSNN	162	17.5	-10	60	500	247	90	94	0.8
1"	Oil mist, fill under pressure	P3YLA18LSNN	184	17.5	-10	60	500	247	90	94	0.8

* flow with 6,3 bar inlet pressure and 0,5 pressure drop.

Technical Information

Fluid:	Compressed air
Maximum inlet pressure*:	17.5 bar
Temperature range*:	-10°C to +60°C

* Air supply must be dry enough to avoid ice formation at temperatures below +2° C
 Low flow start point (lubrication pick-up): at 6.3bar inlet pressure 0.5 dm³/s
 Typical flow with 6.3bar inlet pressure and 0.7 bar pressure drop: 184 dm³/s

Material Specification

Body:	Aluminium
Bowl sight glass:	Polypropylene
Sight dome:	Polyamide
Lubricator cover:	ABS
Bayonet support:	Nylon
Seals:	Nitrile NBR

Dimensions (mm)

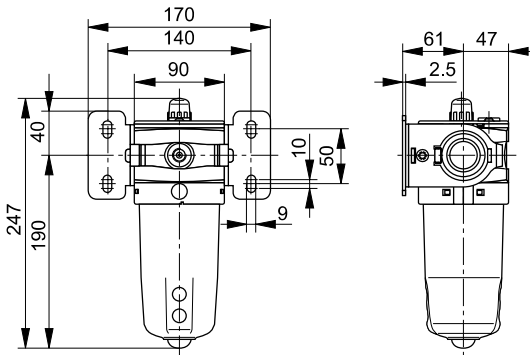

Flow characteristics

(3/4) Lubricator

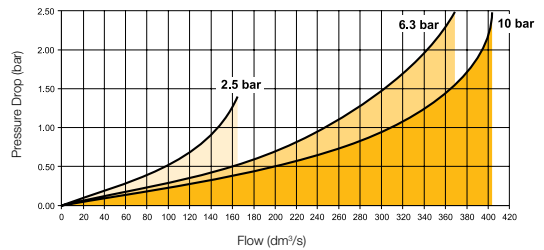

(1") Lubricator

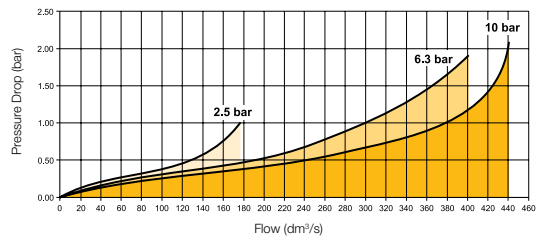

Service kits

Description	Order code
Bowl kit	P3YKA00BSN
Refill plug	P3YKA00PL
Lubricator Oil	P3YKA00PPBB

Proportional Pressure Regulator



- Integral 3/4 or 1" ports (BSPP & NPT)
- Accurate output pressure
- Very fast response times
- Robust but lightweight design.

Options:

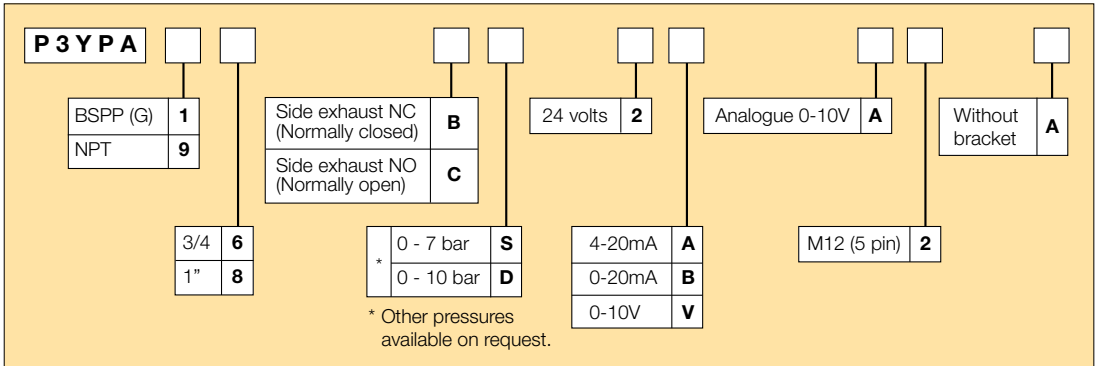

Popular options:

Port size	Description	Order Code	Control signal	Output signal	Output pressure	Weight kg
3/4	Normally closed	P3YPA16BD2VA2A	0 - 10 V	0 - 10 V	0 - 10 bar	1.2
1"	Normally closed	P3YPA18BD2VA2A	0 - 10 V	0 - 10 V	0 - 10 bar	1.2

Technical Information

Operating pressure range	P ¹ min	1 bar
Inlet pressure ¹⁾	P ¹ max	16 bar
Operating pressure range	P ² min	0.2 bar
Outlet pressure	P ² max	10 bar
Operating Temperature	0°C to +50°C	
Maximum Flow	Qn	l/min 20000
		m ³ /h 1200
Hysteresis	P ² max	< 1%
Repeatability	P ² max	< 0.5%
Sensitivity	P ² max	< 0.5%
Linearity	P ² max	< 1%
Nominal voltage	U _n	V DC 24V = ±10%
Residual ripple	10%	
Power consumption	I _{Bmax}	0.15 A
Set value input	U _w	V 0 - 10
	I	mA 0 - 20
		mA 4 - 20
Input resistance	R _E	243 K Ω
Actual valve output	U _x	0 - 10 V
Output current	I _{Amax}	10 mA
Degree of protection	IP65 to DIN 40050, EN 60529	

- ¹⁾ p₁ > p₂ + 10% p₂
- ²⁾ at p₁ - 10 bar to p₂ - 6.3 bar

Dimensions (mm)

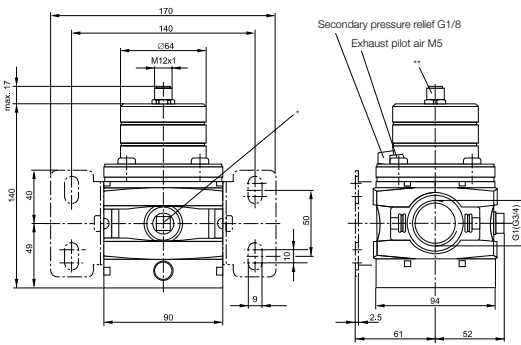

* Two opposite gauge ports G1/4, plug screw mounted
 ** Connection for 5-pin plug M12 x 1

Material Specification

Housing:	Aluminium
Pilot valve booster:	Brass / NBR composite aluminium
Standard seals:	NBR
Body cover screws:	Steel / zinc plated

Connection diagram

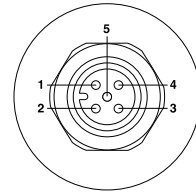

Connector M12 x 1

- Pin 1:** Power supply Plus +24 V DC ± 10% 0.15 A Residual ripple 10%
- Pin 2:** Power supply 0 V Reference and mass capacity for set value and actual value
- Pin 3:** Set value input 0 - 10 V
- Pin 4:** 0 V set signal (connected on board with pin 2 as standard)
- Pin 5:** Analogue actual value output 0 - 10 V Tolerance ± 0.15 V

Flow characteristics

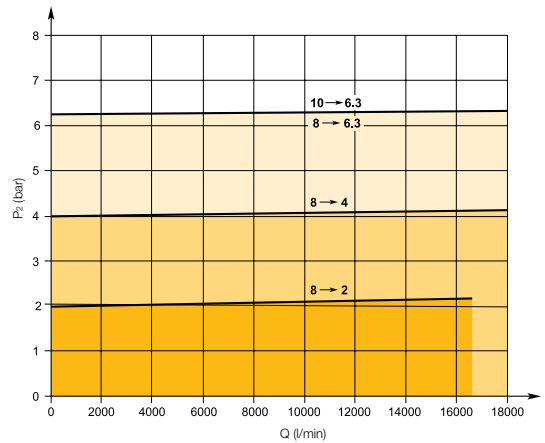

Combined Soft Start Dump Valve and Remote Operated Dump Valve



Symbols

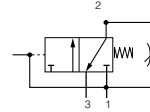

- Modular design with 3/4 & 1" integral ports (BSPP or NPT)
- Provides for the safe introduction of pressure
- Automatically dumps downstream pressure on the loss of pilot signal
- Adjustable slow start
- Solenoid or air pilot options
- High flow & exhaust capability

P3Y Series Combined Soft Start/Dump Valves, provide for the safe introduction of pressure to machines or systems. Soft Start/Dump Valves when set, allow the pressure to gradually build to the set point before fully opening to deliver full flow at line pressure.

The controlled introduction of pressure can be an important safety factor and prevent damage to tooling when air pressure is introduced at machine or system start up.

Options:

P3YTA <input type="checkbox"/>		<input type="checkbox"/>	<input type="checkbox"/>	<input type="checkbox"/>	<input type="checkbox"/>	N	Solenoid type only	
BSPP (G)	1	External air pilot		P	None (operator is fitted to valve)		<input type="checkbox"/>	<input type="checkbox"/>
NPT	9	Solenoid pilot		S	30mm CNOMO coil (Form connection)		<input type="checkbox"/>	000
		3/4	6	30mm operator	C	22mm coil (Form connection)	Solenoid / coil not fitted	
		1"	8	Threaded air pilot	P	30mm CNOMO coil (M12 connection)	24V DC	
						22mm coil (M12 connection)	2CN	
For ATEX Order:								
P3YTA <input type="checkbox"/>				PPNX <input type="checkbox"/>				

Combined soft start dump valve

Port size	Description	Order Code	Flow dm ³ /s	Max bar	Min temp °C	Max temp °C	Height mm	Width mm	Depth mm	Weight kg
3/4	Solenoid operated (not included)	P3YTA16SCN0000	175	16	-10	60	130	90	104	1.5
3/4	24VDC 22mm coil	P3YTA16SCNB2CN	175	16	-10	60	191	90	104	1.6
3/4	Air pilot operated	P3YTA16PPN	175	17.5	-10	60	145	90	104	1.4
1"	Solenoid operated (not included)	P3YTA18SCN0000	200	16	-10	60	130	90	104	1.5
1"	24VDC 22mm coil	P3YTA18SCNB2CN	200	16	-10	60	191	90	104	1.6
1"	Air pilot operated	P3YTA18PPN	200	17.5	-10	60	130	90	104	1.4

Technical Information

Fluid:	Compressed air
Maximum pressure Solenoid operated:	16 bar
Maximum pressure Air Pilot operated:	17.5 bar
Minimum operating pressure:	2 bar
Temperature range* Solenoid operated:	-10° to + 60° C
Temperature range* Air Pilot operated:	-10° to + 60° C
Air Pilot port:	1/8"
Exhaust port:	1"
Gauge port:	1/4"
Typical flow with 6.3bar inlet pressure and 1 bar pressure drop:	3/4" 175 dm ³ /s 1" 200 dm ³ /s

* Air supply must be dry enough to avoid ice formation at temperatures below +2°C
Snap pressure: Full flow when downstream pressure reaches 50% of the inlet pressure

Dimensions (mm)

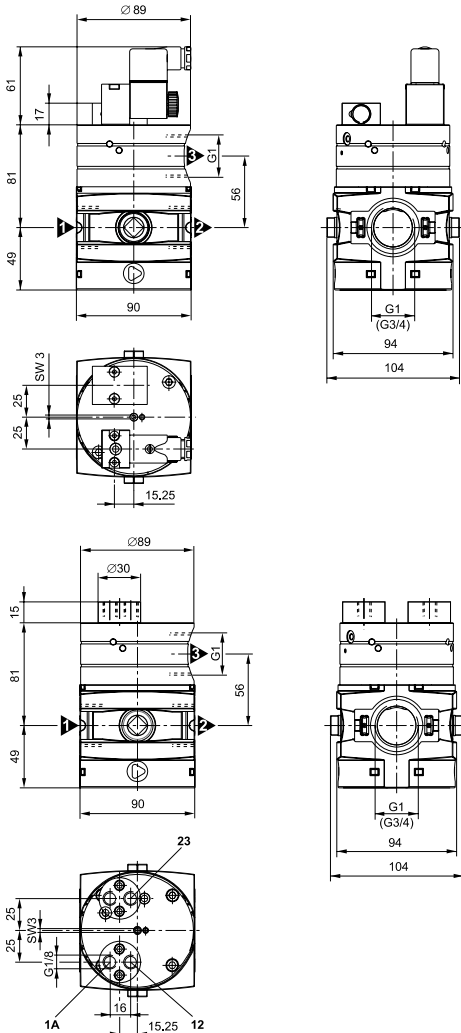

Material Specification

Body:	Aluminium
Body cover:	ABS
Valve:	Brass / NBR composite
Pilot valve booster:	Aluminium
Seals:	Nitrile NBR

Flow characteristics

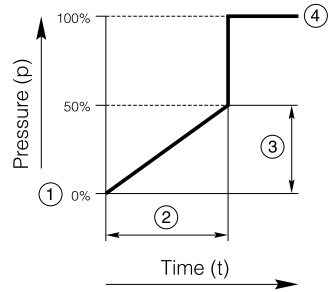

- ① Start signal
- ② Switching time delay
- ③ Gradual pressure build up
- ④ Operating pressure $p_2 (=p_1)$

Combined start/stop function

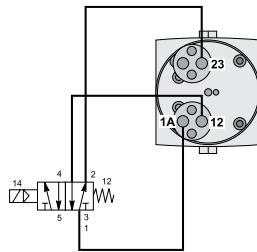

Combined start/stop function with acknowledgement

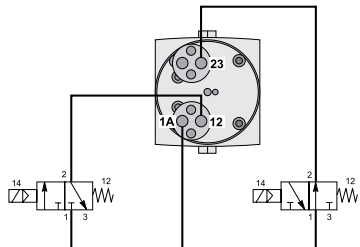

Soft Start Valve



Symbols

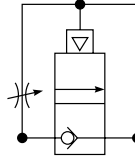

- Integral 3/4" or 1" ports
- Smooth start-up of pneumatic system
- Air pilot operation
- Adjustable slow start
- High flow

Options:

P 3 Y S A	<input type="checkbox"/>	<input type="checkbox"/>	Y	O	N
BSPP (G)	1				
NPT	9				
		3/4	6		
		1"	8		
For ATEX Order:					
P 3 Y S A	<input type="checkbox"/>	<input type="checkbox"/>	Y O N X		

Soft start valve

Port size	Description	Order Code	Flow dm ³ /s	Max bar	Min temp °C	Max temp °C	Height mm	Width mm	Depth mm	Weight kg
3/4	Soft start valve	P3YSA16Y0N	153	175	-10	60	85	90	97	0.8
1"	Soft start valve	P3YSA18Y0N	180	175	-10	60	85	90	97	0.8

Technical Information

Fluid:	Compressed air
Maximum pressure Air Pilot operated:	17.5 bar
Minimum operating pressure:	2 bar
Temperature range* Solenoid operated:	-10° to + 60° C
Temperature range* Air Pilot operated:	-10° to + 60° C
Typical flow with 6.3bar inlet pressure and 1 bar pressure drop:	180 dm ³ /s

* Air supply must be dry enough to avoid ice formation at temperatures below +2°C
 Snap pressure: Full flow when downstream pressure reaches 50% of the inlet pressure

Material Specification

Body:	Aluminium
Body cover:	ABS
Valve:	Brass / NBR composite
Pilot valve booster:	Aluminium
Seals:	Nitrile NBR

Dimensions (mm)

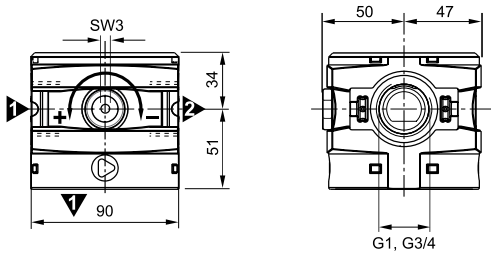

Flow characteristics

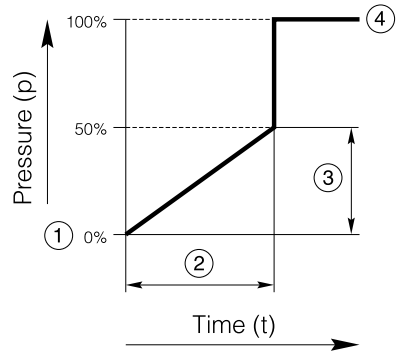

- ① Start signal
- ② Switching time delay
- ③ Gradual pressure build up
- ④ Operating pressure $p^2 (=p^1)$

Pilot Operated Regulator



Symbol

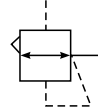

- Integral 3/4 or 1" ports (BSPP & NPT)
- Pilot controlled regulators can be mounted 'out of reach' with pilot regulator installed in a convenient location
- Constant pilot bleed control for accurate pressure control
- Balanced poppet provides quick response
- High flow

Options:

P 3 Y	R A			B P P N
		BSPP (G) 1	G3/4 6	
		NPT 9	G1 8	

Pilot Operated Regulator

Port size	Description	Order Code	Flow dm ³ /s	Max bar	Min temp °C	Max temp °C	Height mm	Width mm	Depth mm	Weight kg
3/4	Pilot operated regulator	P3YRA16BPPN	333	17.5	-10	60	105.5	90	90	1.2
1"	Pilot operated regulator	P3YRA18BPPN	340	17.5	-10	60	105.5	90	90	1.2

* Flow with 10 bar inlet pressure, 6.3 bar set pressure and 1 bar pressure drop.

Technical Information

Flow Capacity:	3/4	333 dm ³ /s
	1"	340 dm ³ /s
Operating Temperature:	-10°C to +60°C	
Maximum Supply Pressure:	17.5 bar	
Weight (g):	3/4	1.2 kg
	1"	1.2 kg

Material specification:

Body:	Aluminium
Body cover:	ABS
Seals:	Nitrile NBR
Screws:	Zinc plated steel
Valve:	Brass / NBR composite
Pilot valve booster:	Aluminium

Dimensions (mm)

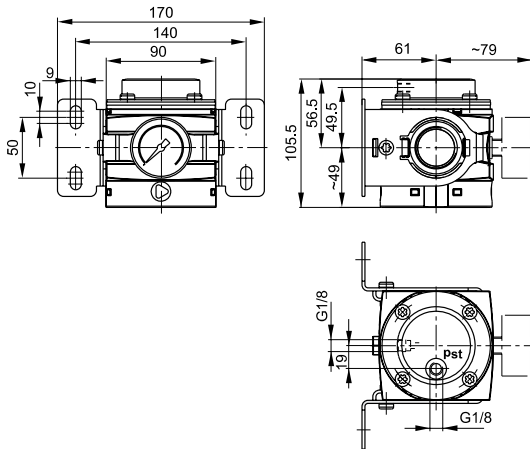

Flow characteristics

Pilot Operated Regulator

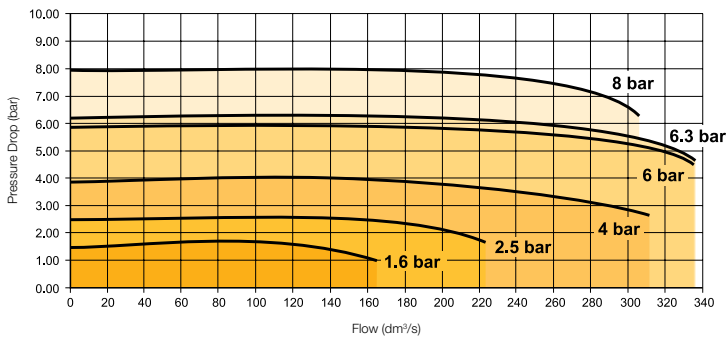

Modular Ball Valve



P3Y Series Ball Valves provide shut off line pressure with a non-sticking 90° turn handle to prevent unauthorised adjustment. When the inlet pressure is turned off the downstream vents through the exhaust port.

Symbols

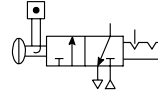

- Positive bubble tight shut-off.
- 90° turn handle to prevent unauthorised adjustment.
- Padlockable (up to 6 times).
- When the inlet pressure is turned off the downstream vents through the exhaust port.

Options:

P 3 Y	VA			LB N
		BSPP (G) 1	3/4" 6	
		NPT 9	1" 8	

Technical Information

Flow Capacity:	3/4	333 dm ³ /s
	1"	333 dm ³ /s
Operating Temperature:	-10°C to +60°C	
Maximum Supply Pressure:	17.5 bar	
Weight (kg):	3/4	1.1
	1"	1.1

Dimensions (mm)

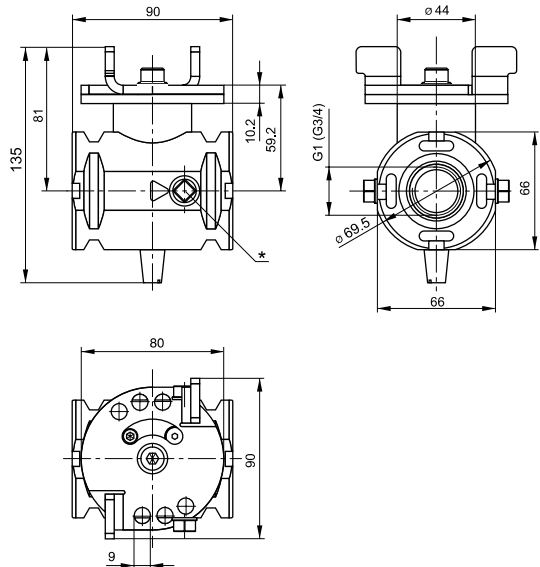

Material specification:

Body:	Aluminium
Valve ball:	Brass / Nickle plated
Handle:	Aluminium
Seals:	Nitrile NBR
Exhaust silencer:	Sintered bronze

Modular Manifold



P3Y Series Manifolds, provide up to 4 extra outlet ports, they may be assembled at any position in a combination e.g. before the lubricator to provide oil free take off or at the end of a combination to provide extra outlet ports.

Thread type	Order code
BSPP	P3YMA1V0N
NPT	P3YMA9V0N

Inlet port	Top	Bottom	Front and Back
3/4"	1/8"	1"	1/4"
1"	1/8"	1"	1/4"

Material specification:

Body:	Aluminium
Weight (kg):	0.7

Dimensions (mm)

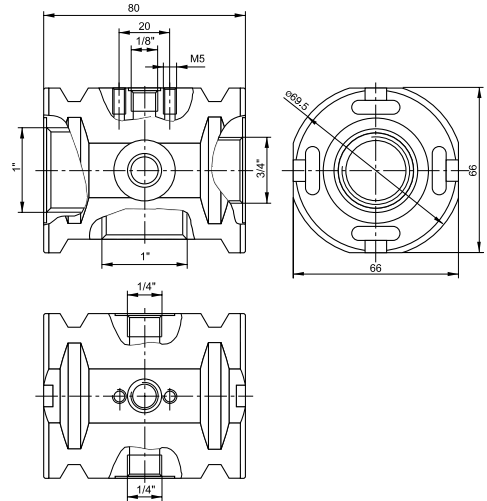

Optional Port Block Kits



- To change port sizes Port Block Kits are available, they are attached to any unit utilising the connecting kit.
- Allows assemblies to be removed from a hard piped system.

Options:

P 3 Y K A	<input type="checkbox"/>	<input type="checkbox"/>	C P
BSPP (G)	1	1 1/4"	A
NPT	9	1 1/2"	B

Material specification:

Body:	Aluminium
Weight (kg):	0.65

Solenoid coils with Din A or Industrial B connection

Voltage	30mm x 30mm Order code DIN A Standard	Weight (Kg)	22mm x 30mm Order code Industrial B standard	Weight (Kg)
Direct current				
12V DC	P2FCA445	0.105	P2FCB445	0.093
24V DC	P2FCA449	0.105	P2FCB449	0.093
48V DC	P2FCA453*	0.105	P2FCB451	0.093
Alternative current				
12V 50/60Hz	P2FCA440	0.105	P2FCB440	0.093
24V 50/60Hz	P2FCA442	0.105	P2FCB442	0.093
48V 50/60Hz	P2FCA469#	0.105		
110V 50Hz, 120V 60Hz	P2FCA453	0.105	P2FCB453	0.093
230V 50Hz, 230V 60Hz	P2FCA457	0.105	P2FCB457	0.093

* P2FCA453 is compatible with 110 V AC and 48 V DC

P2FCA469 is 24 V DC 6.8W or 48 V 50Hz 9.9 VA

Solenoid coils with M12 connection

Voltage	Order code Form A 30 x 30	Weight (Kg)	Order code Form B 22 x 30	Weight (Kg)
Direct current				
24V DC	P2FC6419	0.065	P2FC7419	0.065

Accessories

Description	Connection	Weight (kg)	Order code	
Panel mounting nut (Aluminium)		0.70	P3YKA00MM	
Neck mounting bracket kit		3.75	P3YKA00MS	
Wall mounting brackets		0.2	P3YKA00CW	
P3Y connecting kit		0.05	P3YKA00CB	
Regulator & Filter/Regulator - Key Lock Kit		0.05	P3XKA00AS	
Pressure gauge	0 to 10 bar 0 to 16 bar	1/4" 1/4"	KG8012-00 KG8013-00	
Lubricator Oil	VG32 - 1 litre	0.92	P3YKA00PPBB	
Connector O-ring kit	Qty: 5		P3YKA08CY	



P3Z Series Air Preparation System

1 1/2" & 2" Ported

Filter / Dust Filter

Symbols

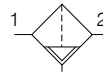

Auto drain

- Flanged 1-1/2" or 2" (BSPP & NPT)
- High efficiency particulate element as standard
- Excellent water removal efficiency
- Robust die-cast aluminium construction
- Standard DPI for monitoring (0.5 - 0.8 bar)

Note: To optimise the life of the dust 1µm element, it is advisable to install a P3ZFA pre-filter with a 5 micron element upstream of the coalescing filter.

Options:

P3ZFA					MA	N
SAE Mtg - No thread	0	None	0	40 Micron Element + DPI Standard	H	Auto Drain
BSPP flange	1	1-1/2"	B	5 Micron Element + DPI Optional	F	MA
NPT flange	9	2"	C	1 Micron Element + DPI	M	

Port size	Description	Order Code	Flow dm ³ /s *	Max bar	Min temp °C	Max temp °C	Bowl capacity cm ³	Height mm	Width mm	Depth mm	Weight kg
-	40 micron, auto drain	P3ZFA00HMAN	>666	17.5	0	60	600	445	200	182	6.3
1-1/2"	40 micron, auto drain	P3ZFA1BHMAN	>666	17.5	0	60	600	445	200	182	6.3
2"	40 micron, auto drain	P3ZFA1CHMAN	>666	17.5	0	60	600	445	200	182	6.3
-	1 micron, auto drain	P3ZFA00MMAN	>666	17.5	0	60	600	445	200	182	6.3
1-1/2"	1 micron, auto drain	P3ZFA1BMMAN	>666	17.5	0	60	600	445	200	182	6.3
2"	1 micron, auto drain	P3ZFA1CMMAN	>666	17.5	0	60	600	445	200	182	6.3

* flow with 6,3 bar inlet pressure and 0,5 pressure drop.

Technical Information

Fluid:	Compressed air
Maximum inlet pressure*:	17.5 bar
Temperature range*:	0°C to +60°C
Particle removal:	40 & 5 micron
Air quality:	Within ISO 8573-1 : 1991 Class 3 and 5 (particulates) Within ISO 8573-1 : 2001 Class 6 and 7 (particulates)
Typical flow with 40µm element 6,3 bar inlet pressure and 0.5 bar pressure drop:	666 dm ³ /s
Auto drain: bowl pressure to close drain Operating range manual override facility (depress pin)	0.8 bar 0.8 to 17.5 bar Ø 10mm brass connection
Bowl sump capacity:	600 cm ³

* Air supply must be dry enough to avoid ice formation at temperatures below +2°C

Material Specification

Body:	Aluminium
Element:	Sintered P.E.
Seals:	Nitrile NBR
Drains: Automatic:	PA / Brass connection
Differential pressure indicator materials:	
Body:	Acetal
Internal parts:	Acetal
Spring:	Stainless steel
Seals:	Nitrile NBR
Support plate	ABS
Screws	Steel / zinc plated

Dimensions (mm)

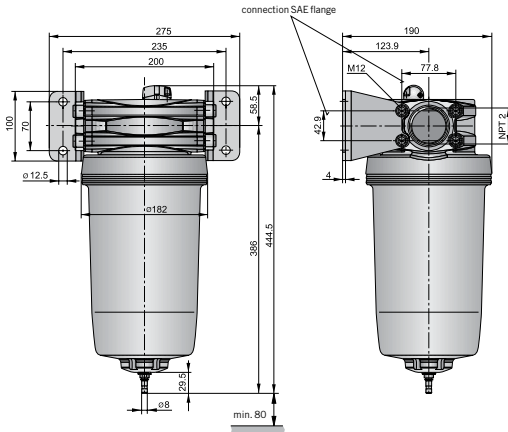

Flow characteristics

(2") 40 Micron Filter

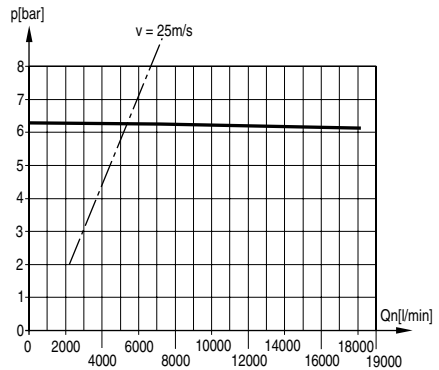

Service kits

Description	Order code
5 micron element kit	P3ZKA00ESE
40 micron element kit	P3ZKA00ESG
1 micron element kit	P3ZKA00ES9

Coalescing Filter / Adsorber Filter



- Extended high efficiency filter element provides greater filtration surface area.
- Flanged 1-1/2" or 2" (BSPP & NPT)
- Removes liquid aerosols and sub micron particles
- Oil free air for critical applications, such as air gauging, pneumatic instrumentation and control

Note: To optimise the life of the coalescing element, it is advisable to install a P3ZFA pre-filter with a 5µm filter upstream of the coalescing filter.

Note: To optimise the life of the adsorber element, it is advisable to install a P3ZFA coalescing 0.01µm filter upstream of the adsorber filter.

Options:

P 3 Z F A					M A		N
SAE Mtg - No thread	0	None	0	0.01 µm Coalescing element + DPI	D	Auto Drain	MA
BSPP flange	1	1-1/2"	B	Adsorber element	B		
NPT flange	9	2"	C				

Port size	Description	Order Code	Flow dm ³ /s *	Max bar	Min temp °C	Max temp °C	Bowl capacity cm ³	Height mm	Width mm	Depth mm	Weight kg
-	Coalescing filter 0.01 µm auto drain	P3ZFA00DMAN	>167	17.5	0	60	600	445	200	182	6.4
1-1/2"	Coalescing filter 0.01 µm auto drain	P3ZFA1BDMAN	>167	17.5	0	60	600	445	200	182	6.4
2"	Coalescing filter 0.01 µm auto drain	P3ZFA1CDMAN	>167	17.5	0	60	600	445	200	182	6.4
-	Adsorber filter	P3ZFA00BMAN	>167	17.5	0	60	600	445	200	182	6.4
1-1/2"	Adsorber filter	P3ZFA1BBMAN	>167	17.5	0	60	600	445	200	182	6.4
2"	Adsorber filter	P3ZFA1CBMAN	>167	17.5	0	60	600	445	200	182	6.4

* flow with 6,3 bar inlet pressure and 0,5 pressure drop.

Technical Information

Fluid:	Compressed air
Maximum inlet pressure*:	17.5 bar
Temperature range*:	0°C to +60°C
Media specifications:	
Coalescing efficiency	(0.3 to 0.6 micron particles): 99.97%
Max. oil carryover (PPM w/w):	0.008 mg/m ³
Typical flow element @ 6,3 bar inlet pressure and 0.2 bar pressure drop:	
	Dry element
	0.01µm @ dm ³ /s
Auto drain:	
bowl pressure to close drain	0.8 bar
Operating range	0.8 to 17.5 bar
manual override facility (depress pin)	Ø 10mm brass connection
Bowl sump capacity:	600 cm ³

* Air supply must be dry enough to avoid ice formation at temperatures below +2°C

Material Specification

Body:	Aluminium
Filter cover:	ABS
Coalescing element:	Borosilicate & Nano fibres
Top & bottom end cap:	Aluminium
Support cylinders:	Grade 430 stainless steel
Support media:	Polypropylene
Anti re-entrainment barrier:	Polyester
Ensapulate:	Epoxy resin / Hardener
Seals:	Nitrile NBR
Drains: Automatic:	PA / Brass connection
Differential pressure indicator materials:	
Body:	Acetal
Internal parts:	Acetal
Spring:	Stainless steel
Seals:	Nitrile NBR
Support plate	ABS
Screws	Steel / zinc plated

Dimensions (mm)

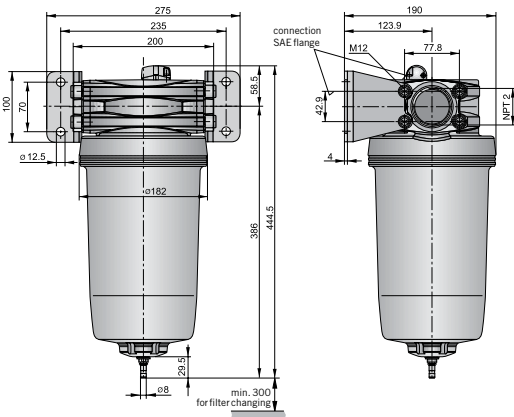

Flow characteristics

(2") 0.01µm Coalescing Filter Saturated

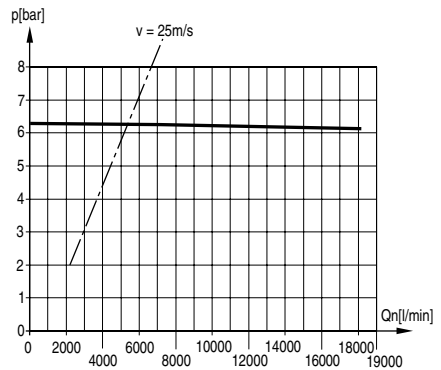

Service kits

Description	Order code
0.01 micron coalescing element kit	P3ZKA00ESC
Adsorber element kit	P3ZKA00ESA
Differential pressure indicator kit	P3ZKA00RQ

Regulator / Pilot Regulator

Symbols

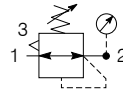

Self relieving regulator with gauge



Air pilot

- Flanged 1-1/2" or 2" ports (BSPP & NPT)
- Robust die-cast aluminium construction
- Secondary pressure ranges 8 & 16 bar
- Rolling diaphragm for extended life
- Secondary aspiration plus rolling diaphragm provides quick response and accurate pressure regulation
- Air pilot regulator permanent bleed

Options:

P 3 Z R A			B	N		N	
SAE Mtg - No thread	0	None	0	Relieving	B	0 - 8 bar No Gauge	N
BSPP flange	1	1-1/2"	B			0 - 16 bar No Gauge	H
NPT flange	9	2"	C			0 - 8 bar Gauge	G
						0 - 16 bar Gauge	J
P 3 Z R A			B P P N				
For Air Pilot Regulator option							

Port size	Description	Order Code	Flow dm ³ /s *	Max bar	Min temp °C	Max temp °C	Height mm	Width mm	Depth mm	Weight kg
-	8 bar relieving + gauge	P3ZRA00BNGN	>666	17.5	0	60	230	180	132	3.5
-	8 bar relieving	P3ZRA00BNNN	>666	17.5	0	60	230	180	132	3.5
1-1/2"	8 bar relieving + gauge	P3ZRA1BBNGN	>666	17.5	0	60	230	180	132	3.5
1-1/2"	8 bar relieving	P3ZRA1BBNNN	>666	17.5	0	60	230	180	132	3.5
2"	8 bar relieving + gauge	P3ZRA1CBNGN	>666	17.5	0	60	230	180	132	3.5
2"	8 bar relieving	P3ZRA1CBNNN	>666	17.5	0	60	230	180	132	3.5
-	16 bar relieving + gauge	P3ZRA00BNJN	>666	17.5	0	60	230	180	132	3.5
-	16 bar relieving	P3ZRA00BNHN	>666	17.5	0	60	230	180	132	3.5
1-1/2"	16 bar relieving + gauge	P3ZRA1BBNJN	>666	17.5	0	60	230	180	132	3.5
1-1/2"	16 bar relieving	P3ZRA1BBNHN	>666	17.5	0	60	230	180	132	3.5
2"	16 bar relieving + gauge	P3ZRA1CBNJN	>666	17.5	0	60	230	180	132	3.5
2"	16 bar relieving	P3ZRA1CBNHN	>666	17.5	0	60	230	180	132	3.5
-	Pilot Regulator + gauge	P3ZRA00BPPN	>666	17.5	0	60	182	180	132	3.4
1-1/2"	Pilot Regulator + gauge	P3ZRA1BBPPN	>666	17.5	0	60	182	180	132	3.4
2"	Pilot Regulator + gauge	P3ZRA1CBPPN	>666	17.5	0	60	182	180	132	3.4

* flow with 10 bar inlet 6,3 bar set pressure and 1 bar pressure drop.

Technical Information

Fluid:	Compressed air
Maximum inlet pressure*:	17.5 bar
Temperature range*:	0°C to +60°C
Typical flow with 10 bar inlet pressure, 8 bar set pressure and 1 bar pressure drop:	2" size >666 dm ³ /s
Gauge port (x 2):	1/4"

* Air supply must be dry enough to avoid ice formation at temperatures below +2°C

Dimensions (mm)

Pressure regulating valve, pilot operated with integrated pilot pressure regulating valve

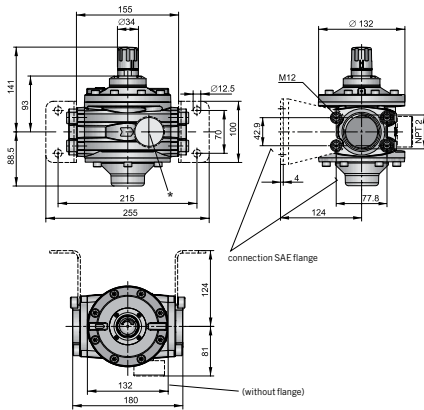

Pressure regulating valve, pilot operated

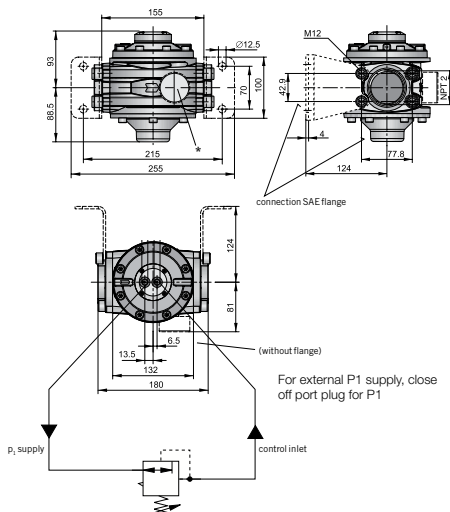

Service kits

Description	Order code
Diaphragm kit (relieving type)	P3ZKA00RR

Material Specification

Body:	Aluminium
Bonnet:	Glass filled polyamide
Control Knob:	Glass filled polyamide
Valve:	Brass / NBR
Seals:	Nitrile NBR
Screws:	Steel / zinc plated

Flow characteristics

Pressure regulating valve characteristics - (2") Pilot operated

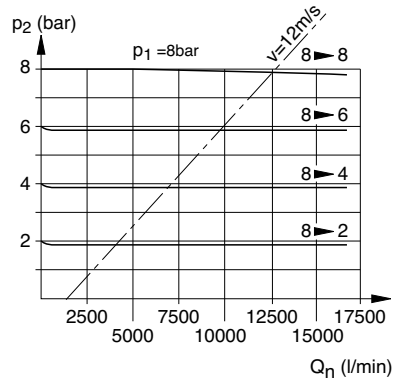

Lubricator



Symbols

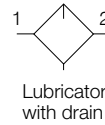

- Flanged 1-1/2" or 2" ports (BSPP & NPT)
- Robust die-cast aluminium construction
- Proportional oil delivery over a wide range of air flows.
- Large oil reservoir

Options:

P 3 Z L A				L S M N	
SAE Mtg - No thread	0	None	0	1-1/2"	B
BSPP flange	1	2"	C		
NPT flange	9				

Port size	Description	Order Code	Flow dm ³ /s *	Max bar	Min temp °C	Max temp °C	Bowl capacity cm ³	Height mm	Width mm	Depth mm	Weight kg
-	Lubricator	P3ZLA00LSMN	>666	17.5	0	60	600	460	200	182	6.5
1-1/2"	Lubricator	P3ZLA1BLSMN	>666	17.5	0	60	600	460	200	182	6.5
2"	Lubricator	P3ZLA1CLSMN	>666	17.5	0	60	600	460	200	182	6.5
2"	Central airline lubricator with electrical oil level control	P3ZLA1CEMMW	>666	10	5	60	5000	608	250	237	18
2"	Central airline lubricator with aluminium bowl	P3ZLA1CMMMWW	>666	10	5	60	5000	608	250	237	18

* flow with 6,3 bar inlet pressure and 0,5 bar pressure drop.

Technical Information

Fluid:	Compressed air
Maximum inlet pressure*:	10 bar
Temperature range*:	5°C to +60°C

* Air supply must be dry enough to avoid ice formation at temperatures below +2° C
 Low flow start point (lubrication pick-up): at 6.3bar inlet pressure 0.5 dm³/s
 Typical flow with 6.3bar inlet pressure and 0.7 bar pressure drop: 184 dm³/s

Material Specification

Body:	Aluminium
Sight dome:	Polyamide
Seals:	Nitrile NBR

Dimensions (mm)

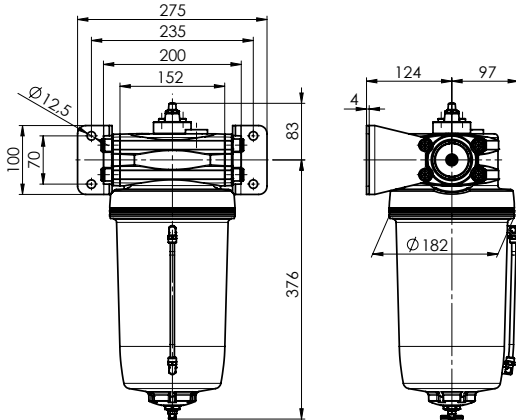

Flow characteristics

(2") Lubricator

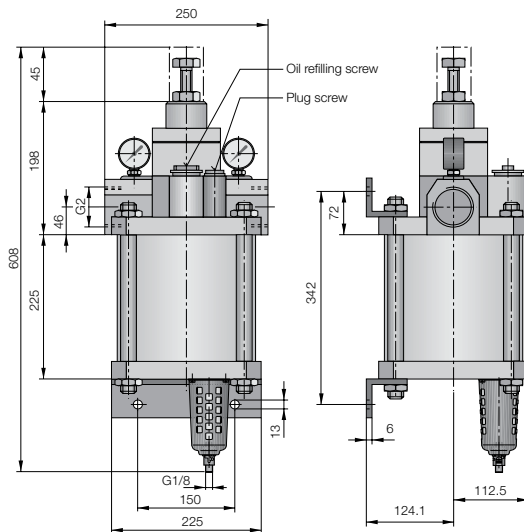
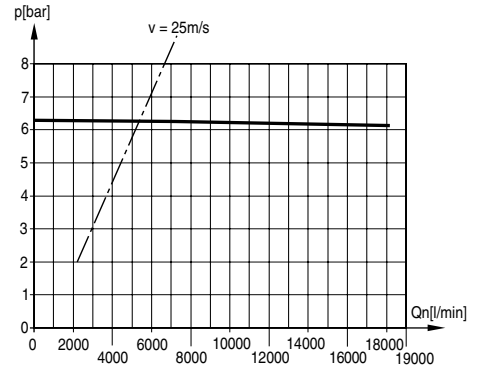

(2") Central Airline Lubricator

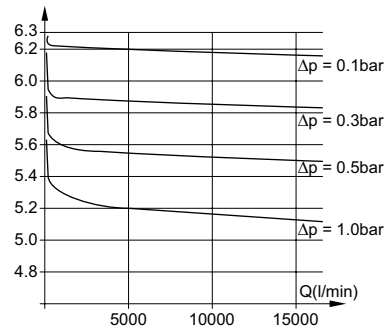

Service kits

Description	Order code
Drip control housing	P3ZKA00PG

Modular Manifold



P3Z Series Manifolds, provide up to 4 extra outlet ports, they may be assembled at any position in a combination e.g. before the lubricator to provide oil free take off or at the end of a combination to provide extra outlet ports.

Thread type	Order code
BSPP	P3ZMA1V0N
NPT	P3ZMA9V0N

Inlet port	Top	Bottom	Front and Back
-	1/8"	1"	1/4"

Dimensions (mm)

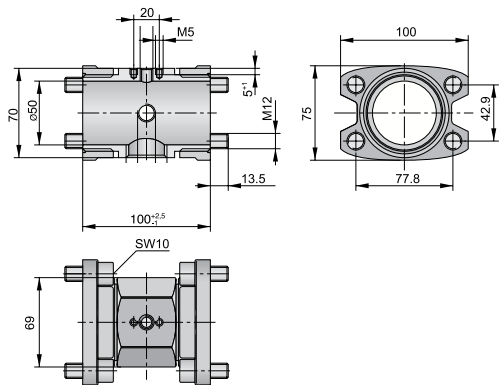

Material specification:

Body:	Aluminium
Weight (kg):	1.1

Connection Flange Kits



- To change port sizes connection flange kits are available, they are attached to any unit utilising the connecting kit.
- Allows assemblies to be removed from a hard piped system.





Options:

P 3 Z K A	<input type="checkbox"/>	<input type="checkbox"/>	C P
BSPP (G)	1	1 1/2"	B
NPT	9	2"	C

Material specification:

Body:	Aluminium
Weight (kg):	0.6

Accessories

Description	Connection	Weight (kg)	Order code	
Modular wall mounting kit		0.2	P3ZKA00MW	
Modular coupling kit		0.8	P3ZKA00CB	
Pressure gauge	0 to 10 bar 0 to 16 bar	1/4" 1/4"	KG8012-00 KG8013-00	
Lubricator Oil	VG32 - 1 litre	0.92	P3YKA00PPBB	
Modular coupling 'O' ring kit	Qty: 5		P3ZKA0CCY	



Moduflex Proportional Regulator

1/4" and 1/2" ported

Man-machine interface

High visibility LED display
Easy to read characters
All controls on the same face

Total flexibility

User friendly and easily accessible software
One basic unit suits all customer requirements

Special applications

Clean line design
Forced exhaust
Side exhaust

Compact & light weight

Small envelope
Light weight

Flexible mounting options

Stand-alone
Foot bracket mounting
DIN-rail mounting
Modular mounting to Moduflex Air Prep

Energy Saving

Low Watt Power Consumption
No Unnecessary Loss of Air in Steady State



Outstanding performance

Very fast response times
Full flow exhaust
Excellent linearity

Generic Industries



The Moduflex Proportional Regulators are designed to quickly and accurately adjust and maintain a set output pressure.

The unit will operate regardless of flow, in response to an electronic control signal. The medium can be compressed air or an inert gas.

Applications for this technology are virtually unlimited; from paint spray control, paper manufacture and printing to weaving and laser cutting control; in fact anywhere that requires accurate remote pressure control.

Automation

In the field of general automation, the need to control processes or movement via electronic signals is of paramount importance. This new unit provides the facility to incorporate pressure control into a fully integrated control system.



Packaging and Food



The Packaging and Food industry provides another ideal area for application of the Electronic Proportional Regulator, where fine control of tension on wrapping foils and paper is required. The degree of control and the ability to manually change parameters makes this unit ideally suited to the varying requirements of this industry.

Automotive

Applications for this innovative product in the Automotive industry can be seen in major manufacturers 'body-in-white' lines.

The control of clamping and welding forces during panel assembly is an ideal application, also accurate control in paint dipping and spraying can be achieved



Why proportional technology ?

The difference between open or closed circuit control

Standard pressure regulators, designed as part of our FRL series go a long way towards meeting our customers needs. In most cases these regulators work well in general pneumatic and automation applications. However, sometimes the application calls for more precise pressure control. The effects of time, cycling, input, back pressure or pressure and flow variation can all cause inconsistencies in pneumatic systems. Our new Proportional Regulators are designed to eliminate those inconsistencies.

Open Control Circuit

In a normal pressure regulated control system, the inlet pressure (p_1) is converted into the output pressure (p_2) by the regulator. The set pressure (set value) is usually manually set by adjusting the control knob and in normal circumstances the regulator maintains the output pressure (actual value). No facility for monitoring the output pressure is provided and there is consequently no way of checking that the set value and the actual value are the same. Also, no account is taken of external influences such as air consumption by the system, which can drastically alter the actual value.

Typical application in automotive body in white welding pressure control

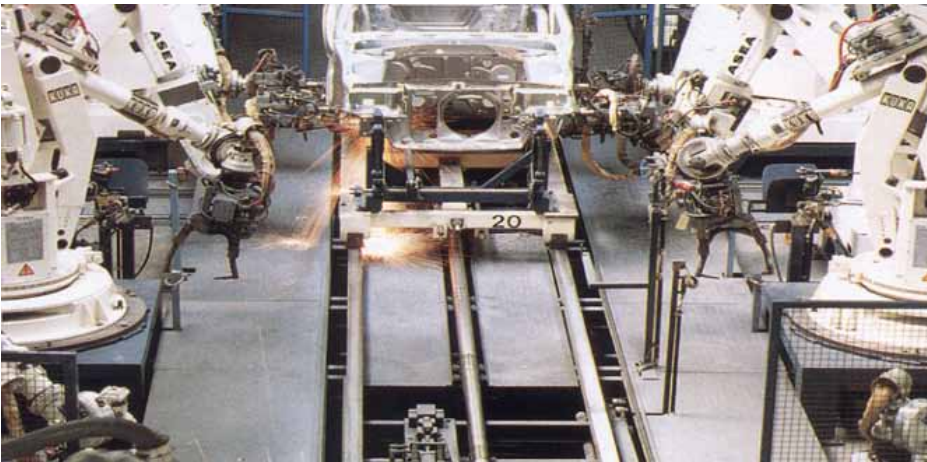

Closed Loop Control Circuit

The input signal (set value) is converted into the output value (actual value) - as in control systems but this output value is continuously measured and compared with the input signal. If they are different, the regulation unit intervenes and adjusts the output value to correspond to the set value.

Proportional Pressure Regulators

The unit provides all the advantages of a closed circuit regulated system. When a set value is defined via the input signal (e.g. 0-10V), the pressure regulator sets the corresponding output pressure (e.g. 0-10 bar). At the same time the integrated pressure sensor measures the actual pressure at the unit's outlet (actual value).

If the electronic regulation system finds that the actual value has deviated from the set value, it immediately corrects the actual value. This is a continuous process ensuring fast, accurate pressure regulation.

- Very fast response times
- Accurate output pressure
- Micro parameter settings
- Selectable I/O parameters
- Quick, full flow exhaust
- LED display indicates output pressure
- No air consumption in steady state
- Multiple mounting options
- Protection to IP65



Order Key

P	3	N	A	1	A	2	1	A
----------	----------	----------	----------	----------	----------	----------	----------	----------

Series
H Moduflex 40 (1/4")
K Moduflex 60 (1/2")

Port type
1 G Thread (BSP)
9 NPT Thread

Port size
2 1/4
4 1/2

Version
A Bottom exhaust
B Side exhaust
E Forced exhaust *

Pressure Range
Z 0 - 2 bar
S 0 - 7 bar
D 0 - 10 bar

Power supply
2 24 volts

Control Signal
A 4-20mA
V 0-10 V

Output Signal
D Digital, PNP (1)
P PNP or 0-10V (2)
N NPN or 0-10V (3)
M 4-20mA fixed (4)

Input connector
1 M12 (4 pin)

On request

* When the supply voltage is lost the unit will automatically exhaust the regulated pressure to 0 bar (atmospheric pressure)

- 1) Digital PNP output only, no analogue output selectable
- 2) Digital PNP and analogue 0-10V outputs selectable, by means of parameter 6. (Factory default 0-10V)
- 3) Digital NPN and analogue 0-10 V outputs selectable by means of parameter 6. (Factory default 0-10V)
- 4) Analogue 4-20mA output only.

Note: On all analogue outputs the F.S. value can be adjusted by means of parameter 8

P3HNA Mounting brackets

Order Code	Description
P3HKA00ML	L-Bracket mounting kit
P3HKA00MC	Foot bracket mounting kit

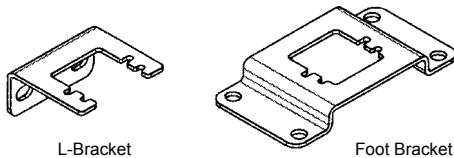

P3KNA Mounting brackets

Order Code	Description
P3KKA00ML	L-Bracket mounting kit
P3KKA00MC	Foot bracket mounting kit

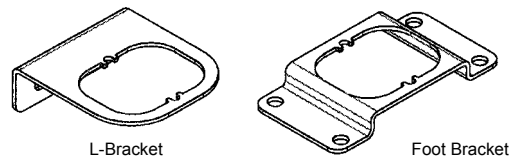

Cables

Order Code	Description
P8L-MC04A2A-M12	2 mtr. cable with moulded straight M12x1 connector
P8L-MC04R2A-M12	2 mtr. cable with moulded 90 degree M12x1 connector.

Popular Options

Port Size	Order Code	Control Signal	Output Signal	Output Pressure
G1/4	P3HNA12AS2VD1A	0-10 V	Digital, PNP only	0 - 7 bar
G1/4	P3HNA12AZ2VD1A	0-10 V	Digital, PNP only	0 - 2 bar
G1/4	P3HNA12AD2VD1A	0-10 V	Digital, PNP only	0 -10 bar
G1/4	P3HNA12AS2AD1A	4-20Ma	Digital, PNP only	0 - 7 bar
G1/4	P3HNA12AZ2AD1A	4-20Ma	Digital, PNP only	0 - 2 bar
G1/4	P3HNA12AD2AD1A	4-20Ma	Digital, PNP only	0 -10 bar
G1/4	P3HNA12AS2AP1A	4-20Ma	Digital, PNP or 0-10V	0 - 7 bar
G1/4	P3HNA12AZ2AP1A	4-20Ma	Digital, PNP or 0-10V	0 - 2 bar
G1/4	P3HNA12AD2AP1A	4-20Ma	Digital, PNP or 0-10V	0 -10 bar
G1/4	P3HNA12AS2AN1A	4-20Ma	Digital, NPN or 0-10V	0 - 7 bar
G1/4	P3HNA12AZ2AN1A	4-20Ma	Digital, NPN or 0-10V	0 - 2 bar
G1/4	P3HNA12AD2AN1A	4-20Ma	Digital, NPN or 0-10V	0 -10 bar
G1/4	P3HNA12AS2AM1A	4-20Ma	4-20mA, analogue only	0 - 7 bar
G1/4	P3HNA12AZ2AM1A	4-20Ma	4-20mA, analogue only	0 - 2 bar
G1/4	P3HNA12AD2AM1A	4-20Ma	4-20mA, analogue only	0 - 10 bar
G1/4	P3HNA12AS2VP1A	0-10 V	Digital, PNP or 0-10V	0 - 7 bar
G1/4	P3HNA12AZ2VP1A	0-10 V	Digital, PNP or 0-10V	0 - 2 bar
G1/4	P3HNA12AD2VP1A	0-10 V	Digital, PNP or 0-10V	0 -10 bar
G1/4	P3HNA12AS2VN1A	0-10 V	Digital, NPN or 0-10V	0 - 7 bar
G1/4	P3HNA12AZ2VN1A	0-10 V	Digital, NPN or 0-10V	0 - 2 bar
G1/4	P3HNA12AD2VN1A	0-10 V	Digital, NPN or 0-10V	0 -10 bar
G1/4	P3HNA12AS2VM1A	0-10 V	4-20mA, analogue only	0 - 7 bar
G1/4	P3HNA12AZ2VM1A	0-10 V	4-20mA, analogue only	0 - 2 bar
G1/4	P3HNA12AD2VM1A	0-10 V	4-20mA, analogue only	0 - 10 bar
G1/2	P3KNA14AS2VD1A	0-10 V	Digital, PNP only	0 - 7 bar
G1/2	P3KNA14AZ2VD1A	0-10 V	Digital, PNP only	0 - 2 bar
G1/2	P3KNA14AD2VD1A	0-10 V	Digital, PNP only	0 -10 bar
G1/2	P3KNA14AS2AD1A	4-20Ma	Digital, PNP only	0 - 7 bar
G1/2	P3KNA14AZ2AD1A	4-20Ma	Digital, PNP only	0 - 2 bar
G1/2	P3KNA14AD2AD1A	4-20Ma	Digital, PNP only	0 -10 bar
G1/2	P3KNA14AS2AP1A	4-20Ma	Digital, PNP or 0-10V	0 - 7 bar
G1/2	P3KNA14AZ2AP1A	4-20Ma	Digital, PNP or 0-10V	0 - 2 bar
G1/2	P3KNA14AD2AP1A	4-20Ma	Digital, PNP or 0-10V	0 -10 bar
G1/2	P3KNA14AS2AN1A	4-20Ma	Digital, NPN or 0-10V	0 - 7 bar
G1/2	P3KNA14AZ2AN1A	4-20Ma	Digital, NPN or 0-10V	0 - 2 bar
G1/2	P3KNA14AD2AN1A	4-20Ma	Digital, NPN or 0-10V	0 -10 bar
G1/2	P3KNA14AS2AM1A	4-20Ma	4-20mA, analogue only	0 - 7 bar
G1/2	P3KNA14AZ2AM1A	4-20Ma	4-20mA, analogue only	0 - 2 bar
G1/2	P3KNA14AD2AM1A	4-20Ma	4-20mA, analogue only	0 - 10 bar
G1/2	P3KNA14AS2VP1A	0-10 V	Digital, PNP or 0-10V	0 - 7 bar
G1/2	P3KNA14AZ2VP1A	0-10 V	Digital, PNP or 0-10V	0 - 2 bar
G1/2	P3KNA14AD2VP1A	0-10 V	Digital, PNP or 0-10V	0 -10 bar
G1/2	P3KNA14AS2VN1A	0-10 V	Digital, NPN or 0-10V	0 - 7 bar
G1/2	P3KNA14AZ2VN1A	0-10 V	Digital, NPN or 0-10V	0 - 2 bar
G1/2	P3KNA14AD2VN1A	0-10 V	Digital, NPN or 0-10V	0 -10 bar
G1/2	P3KNA14AS2VM1A	0-10 V	4-20mA, analogue only	0 - 7 bar
G1/2	P3KNA14AZ2VM1A	0-10 V	4-20mA, analogue only	0 - 2 bar
G1/2	P3KNA14AD2VM1A	0-10 V	4-20mA, analogue only	0 - 10 bar

- Very fast response times
- Accurate output pressure
- Micro parameter settings
- Selectable I/O parameters
- Quick, full flow exhaust
- LED display indicates output pressure
- No air consumption in steady state
- Multiple mounting options



Order Key

P	3	H	P	A	1		A			2				1	A
----------	----------	----------	----------	----------	----------	--	----------	--	--	----------	--	--	--	----------	----------

Port type	
1	G Thread (BSP) Female
9	NPT Thread Female

Port size	
1	1/8
2	1/4

Version	
A	Bottom exhaust
B	Side exhaust
E	Forced exhaust *

Pressure Range	
Z	0 - 2 bar
S	0 - 7 bar
D	0 - 10 bar

Power supply	
2	24 volts

Control Signal	
A	4-20mA
V	0-10 V

Output Signal	
D	Digital, PNP (1)
P	PNP or 0-10V (2)
N	NPN or 0-10V (3)
M	4-20mA fixed (4)

Input connector	
1	M12 (4 pin)

On request

* When the supply voltage is lost the unit will automatically exhaust the regulated pressure to 0 bar (atmospheric pressure)

- 1) Digital PNP output only, no analogue output selectable
- 2) Digital PNP and analogue 0-10V outputs selectable, by means of parameter 6. (Factory default 0-10V)
- 3) Digital NPN and analogue 0-10 V outputs selectable by means of parameter 6. (Factory default 0-10V)
- 4) Analogue 4-20mA output only.

Note: On all analogue outputs the F.S. value can be adjusted by means of parameter 8

P3HKA Mounting brackets

Order Code	Description
P3HKA00MK	DIN rail mounting kit
P3HKA00MF	Foot bracket mounting kit

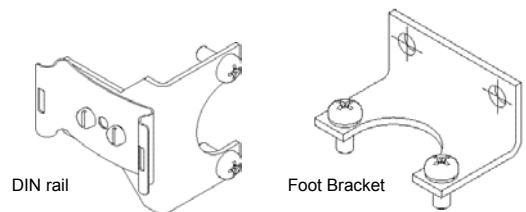

Cables

Order Code	Description
P8L-MC04A2A-M12	2 mtr. cable with moulded straight M12x1 connector
P8L-MC04R2A-M12	2 mtr. cable with moulded 90 degree M12x1 connector.

Popular Options

Port Size	Order Code	Control Signal	Output Signal	Output Pressure
G1/4	P3HPA12AZ2VD1A	0-10 V	Digital, PNP only	0 - 2 bar
G1/4	P3HPA12AS2VD1A	0-10 V	Digital, PNP only	0 - 7 bar
G1/4	P3HPA12AD2VD1A	0-10 V	Digital, PNP only	0 -10 bar
G1/4	P3HPA12AZ2VP1A	0 - 10 V	Digital, PNP or 0-10V	0 - 2 bar
G1/4	P3HPA12AS2VP1A	0 - 10 V	Digital, PNP or 0-10V	0 - 7 bar
G1/4	P3HPA12AD2VP1A	0 - 10 V	Digital, PNP or 0-10V	0 - 10 bar
G1/4	P3HPA12AZ2VN1A	0 - 10 V	Digital, NPN or 0-10V	0 - 2 bar
G1/4	P3HPA12AS2VN1A	0 - 10 V	Digital, NPN or 0-10V	0 - 7 bar
G1/4	P3HPA12AD2VN1A	0 - 10 V	Digital, NPN or 0-10V	0 -10 bar
G1/4	P3HPA12AZ2VM1A	0 - 10 V	4-20mA, analogue only	0 - 2 bar
G1/4	P3HPA12AS2VM1A	0 - 10 V	4-20mA, analogue only	0 - 7 bar
G1/4	P3HPA12AD2VM1A	0 - 10 V	4-20mA, analogue only	0 - 10 bar
G1/4	P3HPA12AZ2AD1A	4-20mA	Digital, PNP only	0 - 2 bar
G1/4	P3HPA12AS2AD1A	4-20mA	Digital, PNP only	0 - 7 bar
G1/4	P3HPA12AD2AD1A	4-20mA	Digital, PNP only	0 -10 bar
G1/4	P3HPA12AZ2AP1A	4-20mA	Digital, PNP or 0-10V	0 - 2 bar
G1/4	P3HPA12AS2AP1A	4-20mA	Digital, PNP or 0-10V	0 - 7 bar
G1/4	P3HPA12AD2AP1A	4-20mA	Digital, PNP or 0-10V	0 - 10 bar
G1/4	P3HPA12AZ2AN1A	4-20mA	Digital, NPN or 0-10V	0 - 2 bar
G1/4	P3HPA12AS2AN1A	4-20mA	Digital, NPN or 0-10V	0 - 7 bar
G1/4	P3HPA12AD2AN1A	4-20mA	Digital, NPN or 0-10V	0 -10 bar
G1/4	P3HPA12AZ2AM1A	4-20mA	4-20mA, analogue only	0 - 2 bar
G1/4	P3HPA12AS2AM1A	4-20mA	4-20mA, analogue only	0 - 7 bar
G1/4	P3HPA12AD2AM1A	4-20mA	4-20mA, analogue only	0 - 10 bar

Technical information

Pneumatics

Working medium

Compressed air or inert gasses, filtered to min. 40µ, lubricated or non-lubricated, dried or un-dried, pressure dewpoint 3-5°C.

Supply pressure

Max. Operating Pressure:
 2 bar unit: 3 bar (43.5 PSI)
 7 bar unit: 10.5 bar (152 PSI)
 10 bar unit: 10.5 bar (152 PSI)
 Min. Operating Pressure P2 Pressure + 0,5 bar (7.3 PSI)

Pressure control range

Available in three pressure ranges, 0-2 bar, 0-7 bar or 0-10 bar. Pressure range can be changed through the software at all times. (parameter 19)

Temperature range

0°C up to +50°C (32°F up to 122°F)

Weights:

P3HP = 285 g
 P3HN = 291 g
 P3KN = 645 g

Air consumption

No consumption in stable regulated situation.

Display

The regulator is provided with a digital display, indicating the output pressure, either in BAR or PSI. The factory setting is as indicated on the label, can be changed through to software at all times (parameter 14).

Electronics

Supply voltage

24 VDC +/- 10%

Power consumption

Max. 1.1W with unloaded signal outputs

Control signals

The electronic pressure regulator can be externally controlled through an analogue control signal of either 0-10V or 4-20mA.(parameter 4).

Output signals

As soon as the output pressure is within the signal band a signal is given of 24V DC, PNP Ri = 1 kOhm. Outside the signal band this connection is 0V.

Connections

(In case of output signal (option D))

Central M12 connector 4-pole

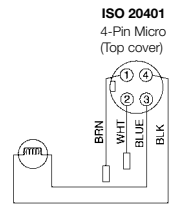

The electrical connections are as follows:

Pin no.	Function	Colour
1	24V supply	brown
2*	0-10V* control signal Ri = 100 kOhm	white
3	0V (GND) supply	blue
4	24V alarm output signal	black

* In case of 4-20 mA the Ri will be 500 Ohm.

Schematic

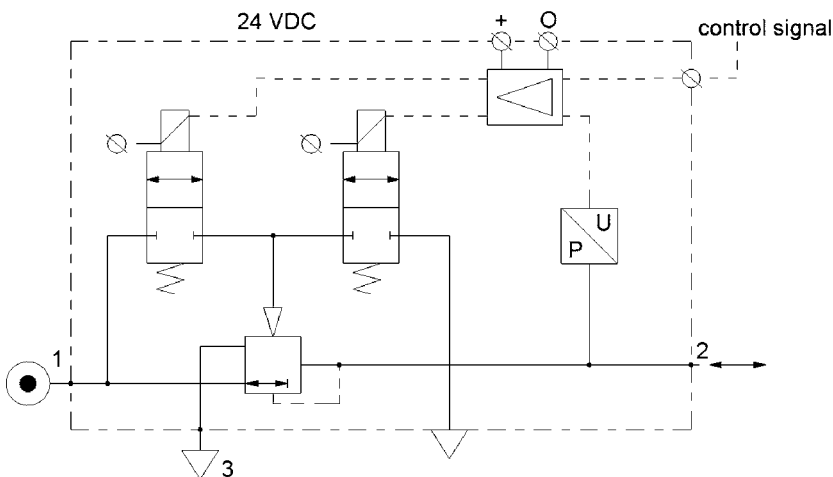

Technical information

Dead band

The dead band is preset at 1,3% F.S.
(parameter 13).

Accuracy

Linearity: = < 0,3% F.S.

Proportional band

The proportional band is preset at 10% F.S.

Fail safe operation

After interrupting the **power supply** the present output pressure is maintained at approximately the same level. After switching on the power supply again the pressure can be adjusted immediately by giving a new control signal.

Full exhaust

Complete exhaust of the regulator is defined as $P2 \leq 1\% \text{ F.S.}$

Full scale (F.S.)

For 2 bar versions this will 2 bar, for the 7 and 10 bar version full scale will be 10 bar.

EU conformity

CE: standard
EMC: according to directive 89/336/EEC
The new pressure regulator is in accordance with:

- EN 61000-6-1:2001**
- EN 61000-6-2:2001**
- EN 61000-6-3:2001**
- EN 61000-6-4:2001**

These standards ensure that this unit meets the highest level of EMC protection.

Mounting position

Preferably vertically, with the cable gland on top.

Materials: P3HN & P3KN Versions

- Magnet CoreSteel
- Solenoid Valve Poppet FPM
- Solenoid Valve Housing Techno Polymer
- Regulator Body (P3HN & P3KN versions) Aluminium
- Regulator Top Housing Nylon
- Valve headBrass & NBR
- Remaining Seals NBR

Materials: P3HP Versions

- Magnet CoreSteel
- Solenoid Valve Poppet FPM
- Solenoid Valve Housing Techno Polymer
- Valve Polyurethane
- Seats and Auxilliary Piston Delrin, Brass
- Remaining Seals NBR
- Port Connections Brass
- Regulator Top HousingABS

Advanced functionality

Pilot valve protection

When the required output pressure can not be achieved because of a lack of input pressure the unit will open fully and will display NoP. Approximately every 10 seconds the unit will retry. The output pressure will then be approximately equal to the inlet pressure. As soon as the input pressure is back on the required level, the normal control function follows.

Safety exhaust

Should the **control signal** fall below 0,1 volts the valve will automatically dump downstream system pressure .

Fail safe

When the supply voltage drops, the electronic control reverts to the fail safe mode. The last known output pressure is maintained at approximately the same level depending upon air consumption. The digital display indicates the last known pressure setting.

When the supply voltage is reinstated to the correct level, the valve moves from the fail safe mode and the output pressure immediately follows the control signal requirement. The display indicates the actual output pressure.

Input protection

The unit has built-in protection against failure and burnout resulting from incorrect input value, typically:

The 24v DC supply is incorrectly connected to the setpoint input, the display will show 'OL', as an overload indication. The unit will need to be rewired and when correctly connected will operate normally.

The overload indicator 'OL' will also appear should the wrong input value be applied or the wrong input value be programmed: 4 - 20m instead of 0 - 10V. To correct this a different set point value should be input or the unit reprogrammed to correct the set point value acceptance. (via parameter 4).

	P3HP Plastic body	P3HN Aluminium body	P3KN Aluminium body
2 to 4 bar	30 msecs	25 msecs	35 msecs
1 to 6 bar	120 msecs	55 msecs	135 msecs
4 to 2 bar	60 msecs	70 msecs	85 msecs
6 to 1 bar	160 msecs	80 msecs	225 msecs

To fill volume of:
100cm³ - P3HP & P3HN
330cm³ - P3KN
connected to the outlet of the regulator.

Flow characteristics

Flow characteristics supply pressure 10 bar (150 PSI)

P3HPA Regulator 1/4" Ports

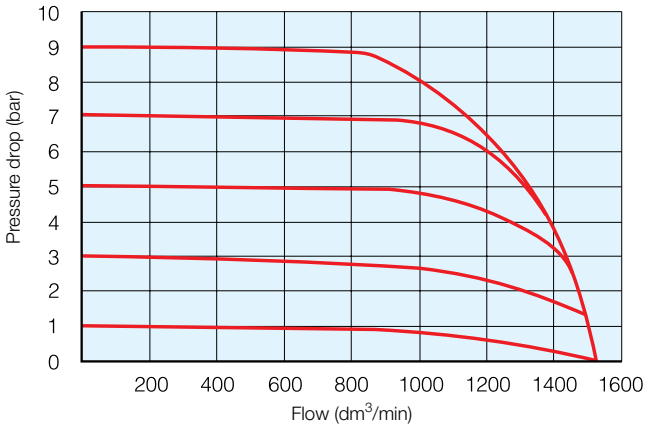

P3HNA Regulator 1/4" Ports

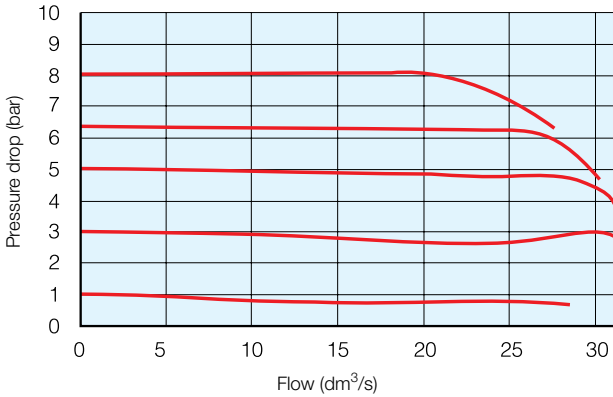

P3KNA Regulator 1/2" Ports

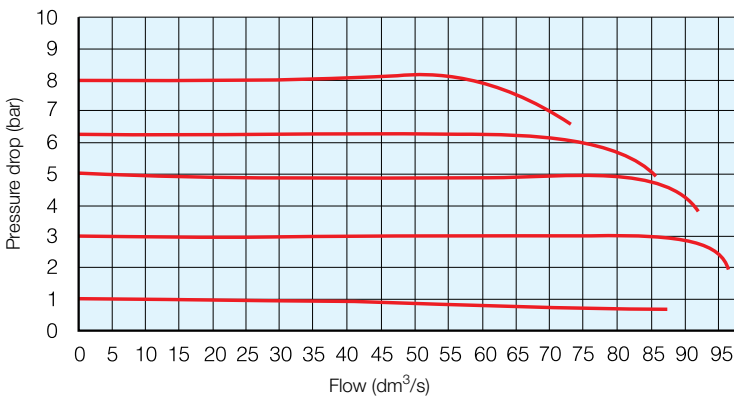

How to change parameters

Pressing the Accept key "acc" for more than 3 seconds, will activate parameter change mode. The user can then select the parameters by pressing up or down key. (display will show Pxx). When parameter number is correct, pressing accept again will enter parameter number.(display will show parameter value).

Pressing the up or down key will change the parameter itself. (display will flash indicating parameter editing mode). Pressing the accept key will accept the new parameter value. (all digits will flash whilst being accepted).

After releasing all keys , the next parameter number will be presented on the display. (you may step to the next parameter). When no key is pressed, after 3 seconds the display will show the actual output pressure.

When the unit is initially powered up allow approximately 10 seconds for the unit to "boot-up" before changing parameter settings.

Only parameter numbers 0, 4, 6, 8, 9, 14, 18, 19, 20, 12, 13 and 21 are accessible to edit. All other parameters are fixed.

Manual mode











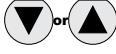

When keys DOWN and UP are pressed during startup, (connecting to the 24V power supply) manual mode is activated. This means that the user is able to in/decrease the output pressure of the P3HP, by pressing the UP or DOWN key. During this action the display will blink, indicating that the manual mode is activated. After powering up again, the unit will revert back to normal mode.

Back to Factory Setting

After start up. (Power is on)

Entering this value in parameter 0 will store the calibrated factory data into the working parameters. (Default calibration data is used)













Parameter Number 0 – Reset Back to Factory Settings

Step	1	2	3	4	5	
Press 	 3-6 seconds					
Until Display Reads			 Flashing Decimal	 Flashing Decimal	 Flashing	
Description	Accesses changeable parameters	Accesses parameter no. 0	Displays current parameter value.	Edits parameter. 3 = standard factory settings. If other than 3, use Up or Down Arrow and accept 3	Accepts and saves new parameter setting.	Sequences to next parameter.













Set Control Signal

The unit is factory set for 0-10 V control signal. If 4-20 mA control signal is required, change parameter 4.













Parameter Number 4 – Set Control Signal in Volts or Milliamps

Step	1	2	3	4	5	
Press 	 3-6 seconds					
Until Display Reads			 Flashing Decimal	 Flashing Decimal	 Flashing	
Description	Accesses changeable parameters	Accesses parameter no. 4	Displays current parameter value. 1 = V 0 = mA	Edits parameter	Accepts and saves new parameter setting.	Sequences to next parameter.

Parameter Number 6 – Set output signal

Step	1	2	3	4	5	
Press 	 3-6 seconds					
Until Display Reads			 Flashing Decimal	 Flashing Decimal (value 0, 1 or 2)	 Flashing	
Description	Accesses changeable parameters	Accesses parameter no. 06	Displays current parameter value. 1 = m factory default for P3H with analog options	Edits parameter 0 = digital (NPN or PNP) 1 = analog 0 .. 10 V 2 = analog 4...20 mA	Accepts and saves new parameter setting.	Sequences to next parameter.













Parameter Number 8 – Adjust span analogue output signal

Step	1	2	3	4	5	
Press 	 3-6 seconds					
Until Display Reads			 Flashing Decimal (for 2 bar versions value = 92)	 Flashing Decimal (value between 0 and 130)	 Flashing	
Description	Accesses changeable parameters	Accesses parameter no. 8	Displays current parameter value.	Edits parameter	Accepts and saves new parameter setting and implements the new analog signal span	Sequences to next parameter.

Adjust Digital Display

If necessary, adjustments can be made to the digital display readout in order to match to an external pressure gauge.













Parameter Number 9 – Adjust Displayed Pressure

Step	1	2	3	4	5	
Press 	 3-6 seconds					
Until Display Reads			 Flashing Decimal	 Flashing Decimal	 Flashing	
Description	Accesses changeable parameters	Accesses parameter no. 9	Displays current digital display.	Use up or down arrows and accept, to match the readout to an external pressure gauge.	Accepts and saves new parameter setting.	Sequences to next parameter.

Set Pressure Scale

Units with NPT port threads are supplied with a factory set PSI pressure scale. Use parameter 14 to change scale to bar.













Parameter Number 14 – Set Pressure Scale in PSI or bar

Step	1	2	3	4	5	
Press 	 3-6 seconds					
Until Display Reads			 Flashing Decimal	 Flashing Decimal	 Flashing	
Description	Accesses changeable parameters	Accesses parameter no. 14	Displays current parameter value. 1 = PSI 0 = bar	Edits parameter	Accepts and saves new parameter setting.	Sequences to next parameter.

Preset Minimum Pressure

If there is a need for a pre-set minimum pressure, use parameter 18. (Note: preset pressure is affected by % P19.)

Parameter Number 18 – Set Minimum Preset Pressure

Step	1	2	3	4	5	
Press 	 3-6 seconds					
Until Display Reads			 Flashing Decimal	 Flashing Decimal (value between 0 and 200)	 Flashing	
Description	Accesses changeable parameters	Accesses parameter no. 18	Displays current parameter value. Incremental value is: <u>2 bar unit:</u> x 2 mbar x % P19 <u>10 bar unit:</u> x 10 mbar x % P19	Edits parameter	Accepts and saves new parameter setting.	Sequences to next parameter.

Set Pressure Correction













Pressure correction allows the user to set a maximum pressure as a percentage of secondary pressure F.S.

Example: If F.S. is 10 bar, set parameter 19 to 50 for maximum preset pressure of 5 bar.

Pressure correction also affects the minimum preset pressure in parameter 18.

Example: If F.S. is 10 bar and parameter 18 is set to a value of 100 (1 bar), and parameter 19 is set to 50%, then the actual minimum preset pressure seen is 0.5 bar.

Parameter Number 19 – Set Maximum Preset Pressure













Step	1	2	3	4	5	
Press 	 3-6 seconds					
Until Display Reads			 Flashing Decimal	 Flashing Decimal (value between 0 and 100)	 Flashing	
Description	Accesses changeable parameters	Accesses parameter no. 19	Displays current parameter value. Incremental value is % of F.S.	Edits parameter	Accepts and saves new parameter setting.	Sequences to next parameter.

Behavior Control

The regulation speed of the pressure regulator can be modified by means of one parameter. (P 20)

The value in this parameter has a range from 0-5. A higher value indicates slower regulation speed, but will be more stable.

Parameter Number 20 – Set Behavior Control

Step	1	2	3	4	5	
Press 	 3-6 seconds					
Until Display Reads			 Flashing Decimal	 Flashing Decimal (value between 0 and 5)	 Flashing	
Description	Accesses changeable parameters	Accesses parameter no. 20	Displays current parameter value.	Edits parameter 0 = custom set* 1 = fastest (narrow proportional band) 2 = fast 3 = normal 4 = slow 5 = slowest (proportional band is broad)	Accepts and saves new parameter setting.	Sequences to next parameter.











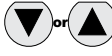

*When the value 0 is entered, you are able to create your own custom settings true parameters 12, 13 and 21.

Fine Settings

Set Proportional Band

Proportional band is used for setting the reaction sensitivity of the regulator. The displayed value is X 10 mbar and has a range between 50 (0.5 bar) and 250 (2.5 bar).













Parameter Number 12 – Set Proportional Band (P20 Must be Set to 0)

Step	1	2	3	4	5	
Press 	 3-6 seconds					
Until Display Reads			 Flashing Decimal	 Flashing Decimal (value between 50 and 250)	 Flashing	
Description	Accesses changeable parameters	Accesses parameter no. 12	Displays current parameter value. Incremental value is X 10 mbar.	Edits parameter	Accepts and saves new parameter setting.	Sequences to next parameter.

Set Deadband













Deadband is the minimum limit of accuracy at which the regulator is set for normal operation. The displayed value is X 10 mbar and has a range between 2 (20 mbar) and 40 (400 mbar).

Parameter Number 13 – Set Deadband (P20 Must be Set to 0)







Step	1	2	3	4	5	
Press 	 3-6 seconds					
Until Display Reads			 Flashing Decimal	 Flashing Decimal (value between 4 and 40)	 Flashing	
Description	Accesses changeable parameters	Accesses parameter no. 13	Displays current parameter value. Incremental value is X 10 mbar.	Edits parameter	Accepts and saves new parameter setting.	Sequences to next parameter.

Proportional Effect

Parameter Number 21 – Set Proportional Effect (P20 Must be Set to 0)

Step	1	2	3	4	5	
Press 	 3-6 seconds			 or 		
Until Display Reads			 Flashing Decimal	 Flashing Decimal (value between 5 and 100)	 Flashing	
Description	Accesses changeable parameters	Accesses parameter no. 21	Displays current parameter value.	Edits parameter 5 = fastest regulation 100 = slowest regulation	Accepts and saves new parameter setting.	Sequences to next parameter.

Parameter Number 39 – Displays Current Software Version

Step	1	2	3	
Press 	 3-6 seconds			
Until Display Reads			 Flashing Decimal	
Description	Accesses parameters	Accesses parameter no. 39	Displays current parameter value. XXX = current software version	

Troubleshooting guide

Problem	Possible Reason	Solution
Display will not light up	No 24 volts power supply	Check if the wiring is connected according to the schematic wiring diagram
Unit will not, or not correctly respond to given setpoint	Wrong current applied (I.e. Volt instead of mA or mA instead of Volt	Change setpoint current or re configure the setpoint current through the software by changing parameter 4 Check wiring if the setpoint signal lead is connected to the right pin within the male M12 connector (should be pin 2)
	Setpoint signal is not stable enough	Stabilize setpoint signal input
Display shows NoP.	Unit detects that required output pressure is higher than the supplied pressure	Adjust the inlet pressure to a higher value, preferably 0,5 bar higher than requested output pressure Give lower setpoint value which corresponds to a output pressure lower than the inlet pressure
	No inlet pressure at all	Connect port 1 to the supply pressure
Unit behaviour is not considered normal	Faulty settings made in the parameters	Reset the unit to factory settings by using the green key function under parameter 0
Desired pressure can not be reached	Setpoint value to low	Increase setpoint value
	Pre-set pressure limit has been changed to a lower max. outlet pressure	Change max. outlet pressure back to required pressure by changing parameter 19
	Supply pressure is to low	Increase supply pressure
Secondary side stays pressurized	Setpoint value is higher than 0,1 Volt	Lower your setpoint value, preferably to 0 Volts
	Pre-set pressure has been enabled to a certain pressure	Reset parameter 18 to 0
Display shows unrealistic value	Display maybe configured in the wrong value (bar instead of psi)	Check through parameter 14, if the display value is set on either psi or bar, if necessary change it to the required setting
Unit response time too slow or too quick	Volume behind the unit is either too big or too small	Adjust the regulating speed of the unit through parameter 20
Unit gives too much overshoot	Relation between volume and response time is out of balance	Adjust response time to a higher value through parameter 20, to acheive more accurate behaviour
Unit is adjusting/regulating constantly	Airleakage in the system behind the unit	Resolve leakage
	Constant changing volume behind the unit	Unit needs to regulate to keep required pressure at the same level Try to minimize the volume changes
	"Deadband "area is set too small	Enlarge deadband setting through parameter 13 in the software (parameter 20 has to be set to 0 before changing parameter 13)
Can not enter software through touchpad	Unit is currently working/processing	Make sure that the unit is in steady state while activating the software
	Activating time is too short	Hold the accept button for at least 3 seconds
Display indicates 'OL'	Wiring not according to diagram (24 volt connected on the setpoint connection pin)	Rewire so that on the setpoint connection pin will be either 0-10v or 4-20mA
	Wrong setpoint value given in relation to programmed setpoint value acceptance	Change over setpoint value to either V or mA or Reprogramme the unit to the correct setpoint value via parameter 4
Any other problem		Please consult factory

Dimensional drawings P3HPA (mm)

Bottom exhaust version

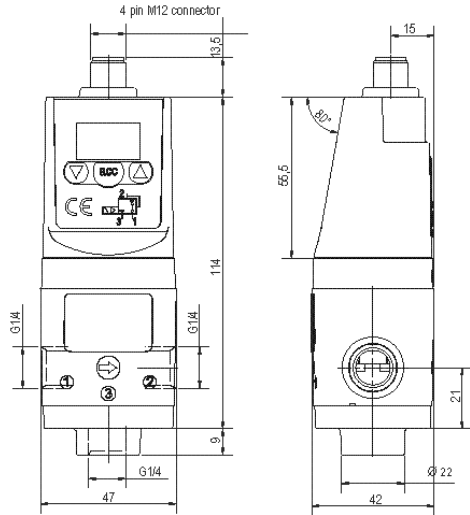

Side exhaust version

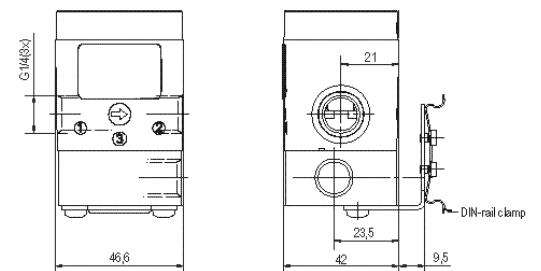
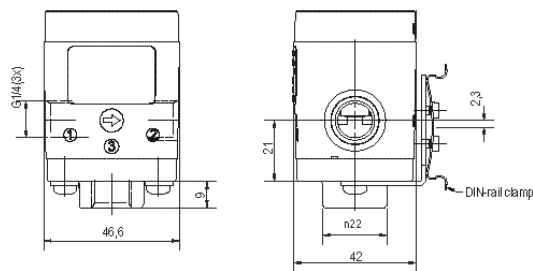
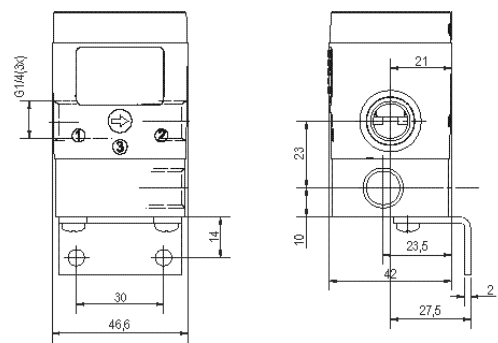
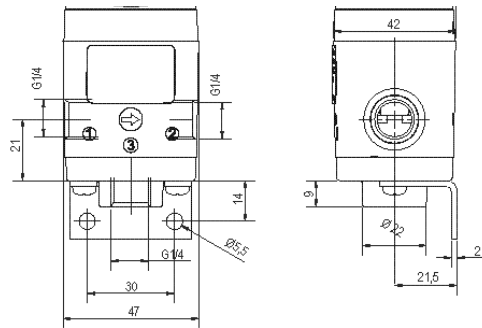
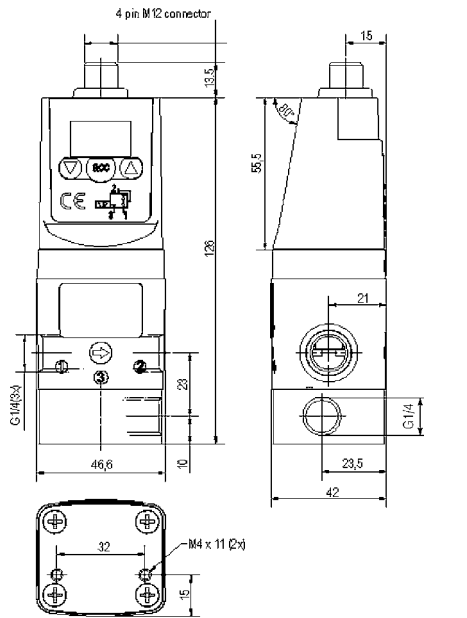

Dimensional drawings P3HNA (mm)

Bottom exhaust version

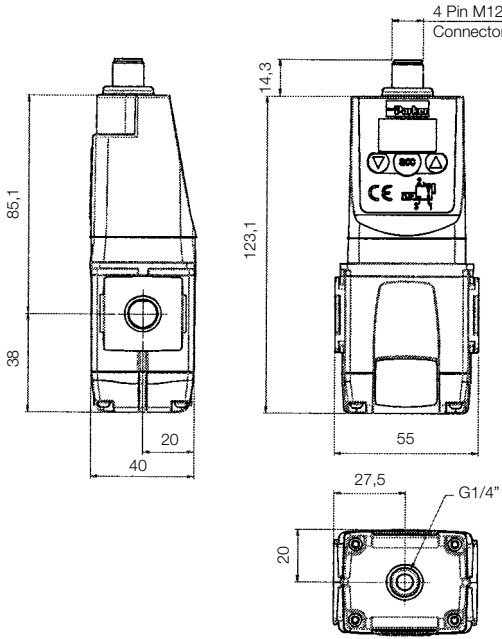

Side exhaust version

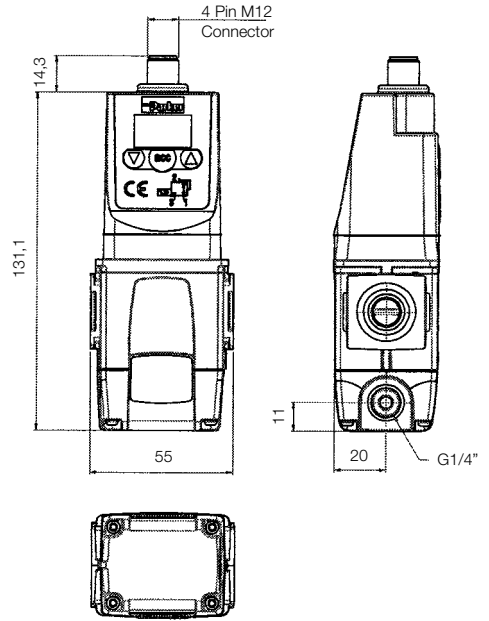

L-Bracket mounting

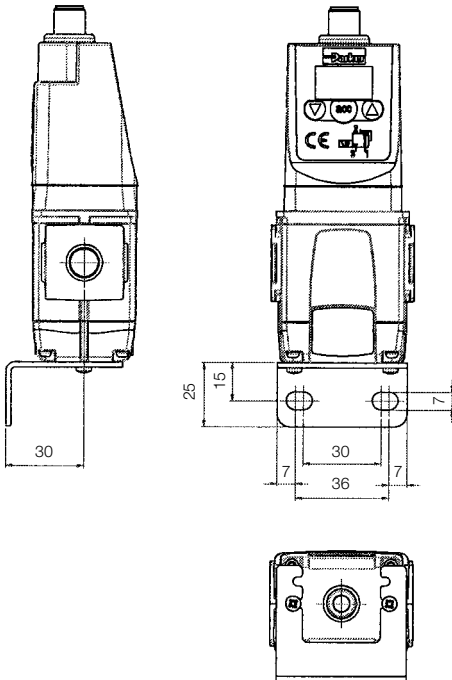

Foot bracket mounting

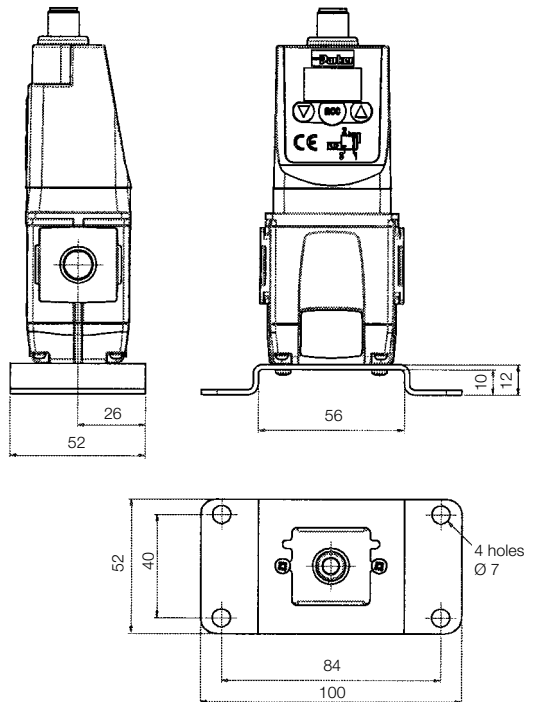

Dimensional drawings P3KNA (mm)

Bottom exhaust version

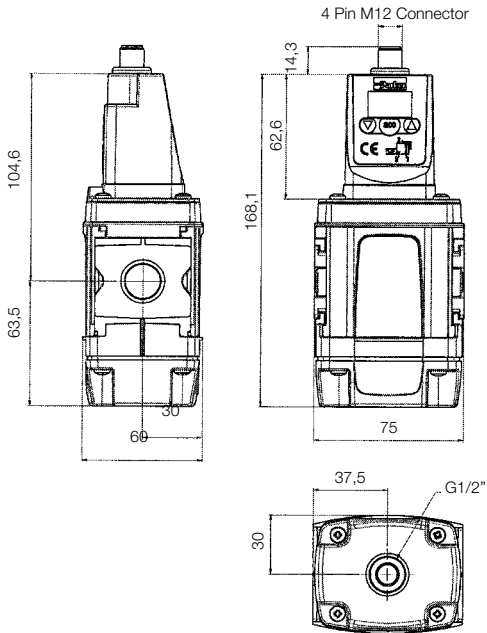

Side exhaust version

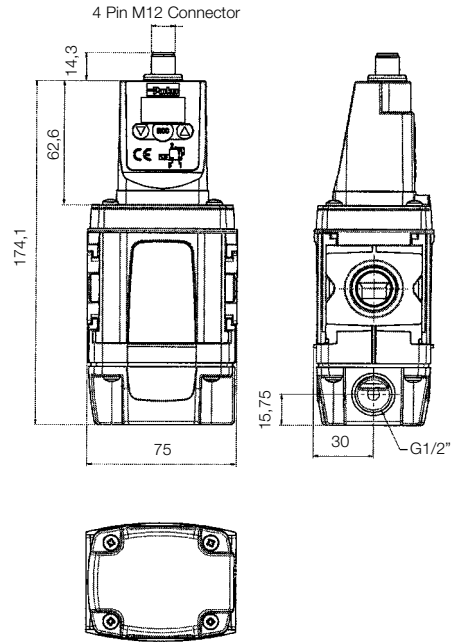

L-Bracket mounting

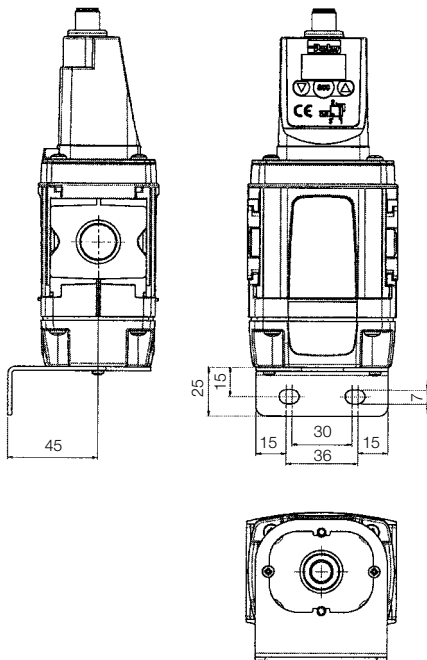

Foot bracket mounting

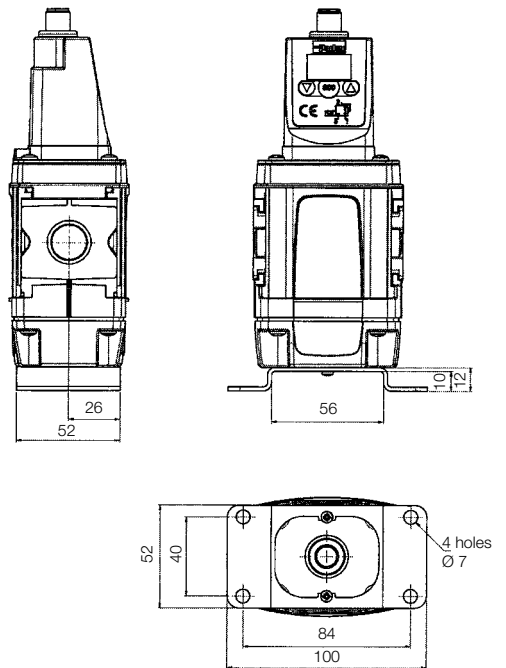

Glossary

Hysteresis - The mechanical limits of accuracy of the unit. The regulator cannot be adjusted within the inherent mechanical limits of the design.

Dead Band - The minimum limit of accuracy at which the regulator is set for normal operation. This band must be equal to, or exceed, the inherent design limits of the regulator or the hysteresis band.

Proportional Band - The band used for setting reaction sensitivity of the regulator. The regulator senses the excursion from the set pressure and adjusts response in relation to the degree of excursion beyond the dead band. This band must exceed the dead band of the unit.

Proportional Effect - The speed at which the unit approaches P2 (secondary pressure).

Sensitivity - The smallest change in the control signal, or feedback signal, to cause a change in regulated output pressure.

Repeatability - A measurement of how consistently the unit can reproduce an output pressure in relation to a specific set pressure.

Linearity - A measure of how closely the relationship of output pressure vs. the control signal deviates from a straight line function.

PNP Output - Referred to as a "Sourcing" open collector transistor output where the voltage sources towards 24VDC when activated.

NPN Output - Referred to as a "Sinking" open collector transistor output. The output sinks towards 0VDC when activated.

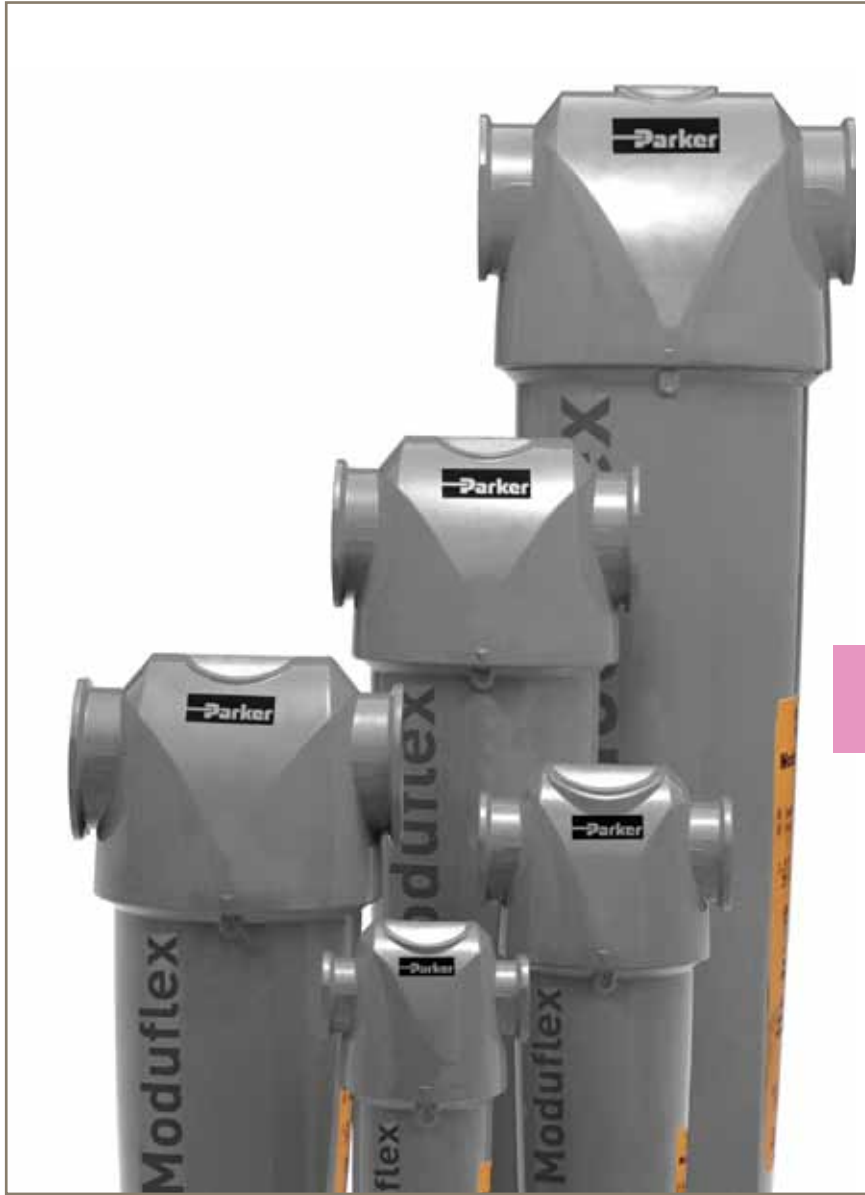
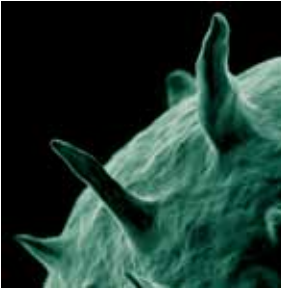

Moduflex Compressed Air Filters

The most energy efficient compressed air filters in the world

Compressed Air - The 4th Utility

Compressed air is a safe and reliable power source that is widely used throughout industry. approximately 90% of all companies use compressed air in some aspect of their operations, however unlike gas, water and electricity, compressed air is generated on-site, giving the user responsibility for air quality and operational costs.

compressed air is not without it's problems, with all systems suffering from performance and reliability issues. almost all of these can be directly attributed to contamination, the main sources of which are :

- the ambient air being drawn into the compressor
- the type and operation of the air compressor
- compressed air storage vessels
- distribution pipework

There are 10 major contaminants found in a compressed air system, these are:

- Water Vapour
- Condensed Water
- Water Aerosols
- Atmospheric Dirt
- Rust
- Pipescale
- Liquid Oil
- Oil Aerosols
- Oil Vapour
- Micro-organisms



The largest quantity of contamination introduced into the compressed air system originates from the atmospheric air drawn into the compressor and not as often believed, introduced by the compressor itself. The most prolific and problematic of the contaminants is water which accounts for 99.9% of the total liquid contamination found in a compressed air system.

High efficiency compressed air filtration is not only used to remove particulate and oil, but more importantly it removes water aerosols and is key to operating an efficient and cost effective compressed air system.

Regardless of what type of compressor is installed, the same level of filtration is required.

Contaminant removal

Failure to remove this contamination can cause numerous problems in the compressed air system, such as:

- Corrosion within storage vessels and the distribution system
- Blocked or frozen valves, cylinders, air motors and tools
- Damaged production equipment
- Premature unplanned desiccant changes for adsorption dryers

In addition to problems associated with the compressed air system itself, allowing contamination such as water, particulate, oil and micro-organisms to exhaust from valves, cylinders, air motors and tools, can lead to an unhealthy working environment with the potential for personal injury, staff absences and financial compensation claims.

Compressed air contamination will ultimately lead to:

- Inefficient production processes
- Spoiled, damaged or reworked products
- Reduced production efficiency
- Increase manufacturing costs

Not all Compressed Air Filters are the same

Compressed air filtration is essential to all modern production facilities. It must deliver promising performance and reliability whilst providing the right balance of air quality with the lowest cost of operation. today,

many manufacturers offer products for the filtration and purification of contaminated compressed air, which are often selected only upon their initial purchase cost, with little or no regard for the air quality they provide

or the cost of operation throughout their life. when purchasing purification equipment, the delivered air quality, cost of operation and the overall cost of ownership must always be considered.

Air quality

Compressed air purification equipment is installed to deliver high quality, clean dry air, and to eliminate the problems and costs associated with contamination. When selecting this type of equipment, the delivered air quality and the verification of performance must always be the primary driver, otherwise why install it in the first place.

- **Moduflex Extras filters provide air quality in accordance with ISO 8573.1:2001, the international standard for compressed air quality**
- **Moduflex Extras adsorption filters are also tested in accordance with the test methods of the ISO 8573 series**
- **Moduflex Extras filter performance has been independently verified by Lloyds Register**
- **Moduflex Extras coalescing filters are covered by a one year compressed air quality guarantee**
- **The air quality guarantee is automatically renewed with annual maintenance**
- **Moduflex Extras coalescing filters are the first range of filters specifically designed to deliver air quality in accordance with ISO 8573.1 : 2001 when tested with the stringent requirements of the new ISO 12500-1 international standard for Compressed Air Filter Testing**

Energy efficiency

After air quality, the next consideration when selecting a compressed air filter is the cost of operation. Moduflex Extras filters not only provide air quality in accordance with the international standards, they are designed to do so with the lowest operational costs available.

- **Moduflex Extras filters use aerospace technology to keep pressure losses to a minimum**
- **Deep pleat element technology and specially treated filtration media provides a low pressure loss filter element with 450% more filtration surface area when compared to a conventional wrapped filter, and 200% greater area than typical pleated filter elements**
- **Overall pressure losses start low and stay low throughout the 12 month life of the filter element**
- **Can help to significantly reduce your carbon footprint**

Alternative Manufacturer Initial saturated differential pressure	Annual Savings with Moduflex Extras	
	Energy Savings Kw	Environmental Saving Kg/CO ₂
200	4,973	2,139
250	6,259	2,691
300	9,619	4,136
350	12,979	5,581
400	16,339	7,026
450	19,699	8,470
500	23,059	9,915

Example based upon :

- System pressure : 7 bar g
- Compressor Size : 120 Kw
- Duration of Operation : 8000 Hrs
- Moduflex Extras Coalescing Filter
0.01 micron (0.01mg/m³)
- Alternative Manufacturer's Coalescing Filter
0.01 micron (0.01mg/m³)

Low lifetime costs

Equipment with a low purchase price may turn out to be a more costly investment in the long term. By guaranteeing air quality and ensuring energy consumption is kept to a minimum, Parker Moduflex Extras filters can reduce the total cost of ownership and help improve your bottom line through improved manufacturing efficiencies.

Air Quality

The Moduflex Extras range of compressed air filters has been designed from the outset to meet the requirements of ISO 8573.1 : 2001,

the International standard for compressed air quality, when validated in accordance with the requirements of ISO 12500, the International standard

for filter testing and the test methods of ISO 8573.2, ISO 8573.4 and ISO 8573.5.

Correct selection of filtration media

Coalescing and dust removal filters use a high efficiency borosilicate glass nanofibre material which has a 96% voids volume, providing media with excellent filtration efficiency and a high dirt holding capacity.

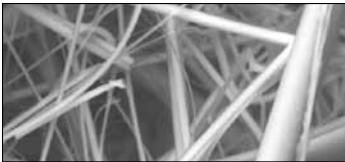

Moduflex Extras coalescing filters utilise four drainage methods to ensure high performance, whilst conventional filters only use one.

Drainage method 1

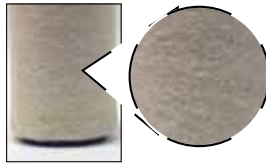

High efficiency drainage layer provides increased liquid drainage, improved chemical compatibility and higher operational temperatures when compared to conventional materials.

Construction of the filtration media into a filter element

Moduflex Extras filter elements use pleated not wrapped filter media, which is constructed using a unique deep bed pleating technique. This provides 450% more filtration surface area when compared to a traditional wrapped filter element and around 200% more surface area compared to a traditional pleated element.

Deep bed pleating also reduces the air flow velocity within the media, which further improves filtration performance.



Drainage method 2

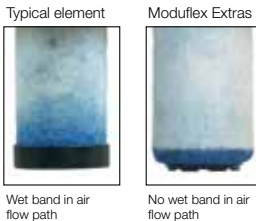

Traditional elements have a build up of liquid known as a "wet band" where the drainage layer is glued into the lower endcap.

The Moduflex Extras design wraps the drainage layer under lower endcap removing coalesced liquid from the air flow path, increasing liquid removal efficiency, and providing more usable filtration surface area.

Drainage method 3

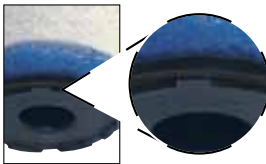

Surface tension breakers are moulded into the lower filter element endcap to prevent liquid from sticking, and to ensure fast and efficient drainage of coalesced liquid.

Drainage method 4

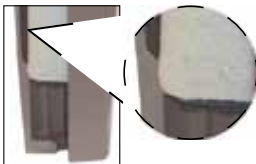

Drainage ribs cast into the filter bowl compress the lower part of the filter element, allowing bulk liquid to rapidly drain from the filter element through capillary action.

Energy Efficiency

Any restriction to airflow within a filter housing / element will reduce the system pressure, to generate compressed air, large amounts of electrical energy is required, therefore any pressure lost within the system can be directly converted into a cost for wasted energy. The higher the pressure loss, the higher the energy costs.

Pressure loss in a compressed air filter is a combination of fixed pressure losses and incremental pressure losses. Fixed pressure losses come from the filter housing and the interface between the filter housing and filter element. Incremental pressure losses come from the filter element as it blocks up with contamination during operation.

In most filters, high operational costs are generally due to a poorly designed airflow path within the filter housing and element and poorly selected filtration media. In addition to this, the high differential pressure change points recommended by many filter manufacturers increase operational costs even further.

Providing an optimal flow path for the compressed air is key to reducing system operating costs.

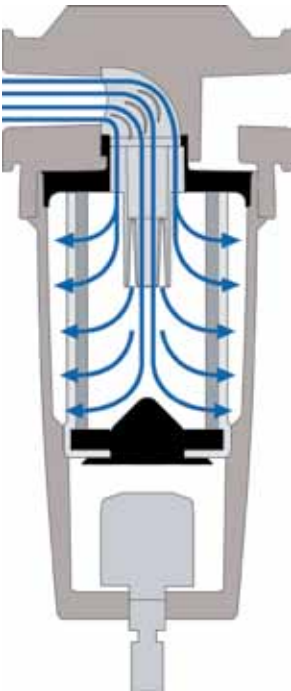

Aerospace Flow Management System

“Bell mouth” housing inlet & full flow inlet conduit



Moduflex Extras filter housings feature a “Bell Mouth” inlet to provide a smooth, turbulent free transition for the air as it enters into the filter element without restriction through the full flow element inlet conduit.

Smooth 90° elbow & aerospace turning vanes



In aerodynamic terms, a design which turns the air sharply through 90° is known as an inefficient corner. This typically has always been the method used to direct air into a compressed air filter element.

Moduflex Extras uses a smooth 90° elbow to direct air into the filter element, reducing turbulence and pressure losses significantly by turning the inefficient, sharp 90° corner into an efficient one.

As the diameter for the conduit increases, the benefits are reduced, therefore filter sizes 3/8” to 3” also include aerospace turning vanes which channels the air through a number of smaller, more efficient corners, reducing pressure loss and energy consumption even further.

Flow distributor



Filter sizes 3/8” to 3” include an upper flow distributor and all models include a lower conical flow diffuser.

The upper flow distributor provides turbulent free distribution of the air flow throughout the filter element ensuring full utilisation of all available filtration media, increasing filtration performance and reducing energy consumption.

Conical flow diffuser



The combination of conical flow diffuser and a drainage layer wrapped under the lower endcap allows airflow through the lowest section of the element, which is not possible on conventional filters due to the position of the “wet band”.

Advanced Filter housing

Moduflex Extras filter housings have been designed to provide simple installation, long housing life and reduced maintenance times.

The unique design of the Moduflex Extras filter provides more port sizes for flexibility and ensures service

technicians do not have to contact contaminated elements during maintenance.



No corrosion with Alocrom treatment.



Rapid corrosion of untreated aluminium.



Float drain

Filter connections

Port sizes are available to match both pipe size and system flow rate giving additional customer choice and reduced installation costs.

Compact and lightweight

Advanced element design provides a smaller, more compact filter.

Fully corrosion protected

All Moduflex Extras filters undergo cleaning, de-greasing and Alocrom treatment before painting. Alocrom treatment not only primes the aluminium surface for painting, it also provides corrosion protection. Additionally, all Moduflex Extras filter housings are also externally protected with a tough, durable dry powder epoxy coating.

Moduflex Extras filter housings are provided with a 10 year housing guarantee.

'Clean change' filter element

Element changes are now easy and do not require the user to touch the contaminated element during annual element change.

Minimal service clearance

Space saving design minimises service clearance and allows installation in confined spaces.

Choice of drains

Coalescing filters are fitted as standard with energy efficient, zero air loss float drains for the removal of coalesced liquids. Adsorption filters are fitted with a manual drain.

Optional accessories

Additional mounting and interconnecting hardware is available.



LRQ4003083



LRQ4001479

INTERNATIONAL APPROVALS



CRN



ASME VIII National Board

AS1210



BRITISH COMPRESSED AIR SOCIETY LIMITED



Maintaining air quality and energy efficiency through regular maintenance

It has long been the practice to change filter elements based upon the pressure drop measured across the filter as this is directly attributable to operational costs.

However, one must remember the reason for installing the filter in the first place, i.e. to remove contamination.

Filter elements must always be replaced in accordance with the manufacturers instructions to ensure the delivered air quality is never compromised.

'Why should I change my filter element?'

To achieve the stringent air quality levels required by both modern industry and ISO 8573.1 : 2001 the international standard for compressed air quality, highly specialised filtration materials are employed, which has both a finite life and a finite capacity to retain contamination.

It is important to remember that when the filter life has expired, the required air quality can no longer be maintained.

Filters are installed to provide contaminant removal to a specific air quality requirement, therefore the primary reason to change filter elements should always be to maintain air quality.

Filter elements should be changed based upon manufacturers recommendations to maintain air quality.

"My filter is fitted with a differential pressure gauge and the needle is in the green - why should I change my element ?"

Many filter housings are fitted with "Differential Pressure Gauges". Generally, these are indicators not precise gauges and offer no level of calibration. Typically these will show an area of green and red, indicating if the needle is in the green, that the element does not require changing.

Differential pressure gauges are not filter service indicators or air quality indicators, they are simply measuring differential pressure and offer an indication of premature blockage.

As the filter media in an element degrades, even a tiny hole can result in the filter media rupturing, allowing all contamination to be carried past the filter into the system. If this should happen, the needle on the gauge would always indicate in the green area and the element would never be serviced until the user spotted contamination downstream. If the element was replaced after such an incident, contamination will still be present downstream of the filter for some time.

What are the consequences of not changing filter elements?

What seems like a cost saving in the short term can turn out to be a very costly mistake. Having identified a contamination problem in the compressed air system and the need for purification equipment, what would be the cost to your business of poor air quality?

- **Damaged adsorption dryer beds requiring unplanned desiccant changes**
- **Corrosion within the compressed air storage and distribution system**
- **Blocked / frozen valves and air motors**
- **Damaged machinery**
- **Contamination exhausting from valves and cylinders leading to unhealthy working environments, risk of personal injury, staff absences and personal injury claims**
- **Inefficient production processes**
- **Spoiled, damaged products**
- **Re-worked products**
- **Increased manufacturing costs**
- **Increased production downtime**



What are the benefits of regularly changing filter elements?

- **High quality compressed air - Guaranteed**
- **Protection of adsorption dryer beds**
- **Protection of downstream equipment, personnel and processes**
- **Reduced operational costs**
- **Increased productivity & profitability**
- **Continued peace of mind**

High Efficiency 0.01 µm Filtration

Filtration Grade

Filtration type	Coalescing
Particle removal (inc water & oil aerosols)	Down to 0.01 micron
Max remaining oil content at 21°C	0.01 mg/m ³ 0.01 ppm(w)
Filter efficiency	99.9999%
Test methods used	ISO 8573.2 ISO 8573.4 ISO 12500-1
ISO 12500-1 Inlet Challenge concentration	10 mg/m ³
Initial dry differential pressure	<140 mbar (2psi)
Initial saturated differential pressure	<200 mbar (3psi)
Change element every	12 months
Precede with filtration grade	1 micron Moduflex Coalescer



Product selection

Stated flows are for operation at 7 bar (g) with reference to 20°C, 1 bar (a), 0% relative water vapour pressure. For flows at other pressures apply the correction factors shown.

Port Size	Part Number	dm ³ /s	m ³ /hr	cfm	0.01 µm Replacement Element Kit
1/4"	P3TFA22CAAN	10	36	21	P3TKA00ESCA
3/8"	P3TFA23CBAN	20	72	42	P3TKA00ESCB
1/2"	P3TFA24CCAN	30	108	64	P3TKA00ESCC
3/4"	P3TFA26CDAN	60	216	127	P3TKA00ESCD
1"	P3TFA28CEAN	110	396	233	P3TKA00ESCE
1.1/4"	P3TFA2ACEAN	110	396	233	P3TKA00ESCE
1.1/2"	P3TFA2BCFAN	160	576	339	P3TKA00ESCF
1.1/2"	P3TFA2BCGAN	220	792	466	P3TKA00ESCG
2"	P3TFA2CCHAN	330	1188	699	P3TKA00ESCH
2.1/2"	P3TFA2DCJAN	430	1548	911	P3TKA00ESCJ
3"	P3TFA2ECJAN	430	1548	911	P3TKA00ESCJ
2.1/2"	P3TFA2DCKAN	620	2232	1314	P3TKA00ESCK
3"	P3TFA2ECKAN	620	2232	1314	P3TKA00ESCK

Correction factors

Line pressure bar g	psi g	Correction factor
1	15	0.38
2	29	0.53
3	44	0.65
4	58	0.76
5	73	0.85
6	87	0.93
7	100	1.00
8	116	1.07
9	131	1.13
10	145	1.19
11	160	1.25
12	174	1.31
13	189	1.36
14	203	1.41
15	218	1.46
16	232	1.51

To find the correction factor for 8.5 bar g (122psi g) =

$$\sqrt{\frac{\text{System Operating Pressure}}{\text{Nominal Pressure}}} = \sqrt{\frac{8.5 \text{ bar g}}{7 \text{ bar g}}} = 1.10$$

Filter selection example

Selecting a filter model to match a system flow rate and pressure.

Example: System flow 1050 m³/hr at a pressure of 8.5 bar g

1. Obtain pressure correction factor from table or calculate factor using method shown. Correction factor for 8.5 bar g = 1.10
2. Divide system flow by correction factor to give equivalent flow rate at 7 bar g 1050m³/hr ÷ 1.10 = 955 m³/hr (at 7 bar g)
3. Select a filter model from the above table with a flow rate above or equal to 955 m³/hr. Filter model selected : P3TFA2CCHAN
4. Select pipe connection & Thread type System uses 2" piping and BSP threads: Model P3TFA2CCHAN

High Efficiency 0.01 µm Filtration

Technical data

Filter Grade	Drain type	Max operating pressure		Max recommended operating temp.		Min recommended operating temp.	
		bar g	psi g	°C	°F	°C	°F
0.01 micron	Auto	16	232	80°C	176°F	1.5°C	35°F

Weights and dimensions

Optional Accessories

Port Size	Part Number	A		B		C		D		E		F		G		Weight		Modular Connection Kit	Wall Mounting Bracket Kit
		mm	ins	mm	ins	mm	ins	mm	ins	mm	ins	mm	ins	mm	ins	kg	lbs		
1/4"	P3TFA22CAAN	76.0	3.0	181.5	7.2	153.0	6.0	18.0	0.71	24.5	0.96	30.0	1.18	52.0	2.05	0.4	0.9	P3TKA00CBA	P3TKA00MWA
3/8"	P3TFA23CBAN	97.5	3.8	235.0	9.3	201.0	7.9	20.5	0.81	25.5	1.00	40.0	1.57	60.0	2.36	1.0	2.2	P3TKA00CBB	P3TKA00MWB
1/2"	P3TFA24CCAN	97.5	3.8	235.0	9.3	201.0	7.9	20.5	0.81	25.5	1.00	40.0	1.57	60.0	2.36	1.0	2.2	P3TKA00CBB	P3TKA00MWB
3/4"	P3TFA26CDAN	129.0	5.1	275.0	10.8	232.5	9.2	23.0	0.91	28.0	1.10	60.0	2.36	68.0	2.68	2.2	4.8	P3TKA00CBD	P3TKA00MWD
1"	P3TFA28CEAN	129.0	5.1	364.5	14.3	322.0	12.7	23.0	0.91	28.0	1.10	60.0	2.36	68.0	2.68	2.6	5.7	P3TKA00CBD	P3TKA00MWD
1.1/4"	P3TFA2ACEAN	129.0	5.1	364.5	14.3	322.0	12.7	23.0	0.91	28.0	1.10	60.0	2.36	68.0	2.68	2.6	5.7	P3TKA00CBD	P3TKA00MWD
1.1/2"	P3TFA2BCFAN	170.0	6.7	432.5	17.0	382.5	15.1	32.0	1.26	39.0	1.54	84.0	3.31	92.0	3.62	4.5	9.9	P3TKA00CBF	P3TKA00MWF
1.1/2"	P3TFA2BCGAN	170.0	6.7	524.5	20.6	474.5	18.7	32.0	1.26	39.0	1.54	84.0	3.31	92.0	3.62	5.3	11.6	P3TKA00CBF	P3TKA00MWF
2"	P3TFA2CCHAN	170.0	6.7	524.5	20.6	474.5	18.7	32.0	1.26	39.0	1.54	84.0	3.31	92.0	3.62	5.3	11.6	P3TKA00CBF	P3TKA00MWF
2.1/2"	P3TFA2DCJAN	205.0	8.1	641.5	25.3	581.5	22.9	35.5	1.40	42.5	1.67	100.0	3.94	135.0	5.31	10.0	22.0	P3TKA00CBJ	P3TKA00MWJ
3"	P3TFA2ECJAN	205.0	8.1	641.5	25.3	581.5	22.9	35.5	1.40	42.5	1.67	100.0	3.94	135.0	5.31	10.0	22.0	P3TKA00CBJ	P3TKA00MWJ
2.1/2"	P3TFA2DCKAN	205.0	8.1	832.0	32.8	772.0	30.4	35.5	1.40	42.5	1.67	100.0	3.94	135.0	5.31	12.0	26.4	P3TKA00CBJ	P3TKA00MWJ
3"	P3TFA2ECKAN	205.0	8.1	832.0	32.8	772.0	30.4	35.5	1.40	42.5	1.67	100.0	3.94	135.0	5.31	12.0	26.4	P3TKA00CBJ	P3TKA00MWJ

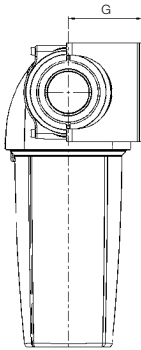
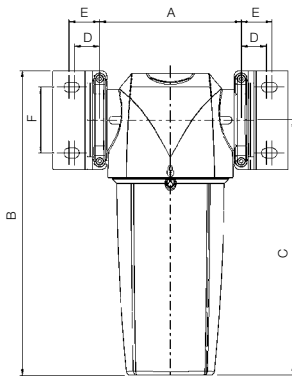

DPI Kit

P3TKA00RQ

Incident Monitor

Used to indicate premature high differential pressure. Indicator can be retrofitted to existing housings without depressurising the system.



Wall Mounting Bracket Kit

Mounting brackets provide additional support to filters installed in flexible piping systems or OEM equipment.



Modular Connection Kit

Fixing clamp allows quick and simple connection of multiple filter housings.

Drain Kits

Auto drain P3TKA00DA

Manual drain P3TKA00DM

1 µm Filtration

Filtration Grade

Filtration type	Coalescing
Particle removal (inc water & oil aerosols)	Down to 1 micron
Max remaining oil content at 21°C	0.06 mg/m ³ 0.05 ppm(w)
Filter efficiency	99.925%
Test methods used	ISO 8573.2 ISO 8573.4 ISO 12500-1
ISO 12500-1 Inlet Challenge concentration	40 mg/m ³
Initial dry differential pressure	<70 mbar (2psi)
Initial saturated differential pressure	<140 mbar (3psi)
Change element every	12 months
Precede with filtration grade	1 micron Moduflex Coalescer



Product selection

Stated flows are for operation at 7 bar (g) with reference to 20°C, 1 bar (a), 0% relative water vapour pressure. For flows at other pressures apply the correction factors shown.

Port Size	Part Number	dm ³ /s	m ³ /hr	cfm	1 µm Replacement Element Kit
1/4"	P3TFA229AAN	10	36	21	P3TKA00ES9A
3/8"	P3TFA239BAN	20	72	42	P3TKA00ES9B
1/2"	P3TFA249CAN	30	108	64	P3TKA00ES9C
3/4"	P3TFA269DAN	60	216	127	P3TKA00ES9D
1"	P3TFA289EAN	110	396	233	P3TKA00ES9E
1.1/4"	P3TFA2A9EAN	110	396	233	P3TKA00ES9E
1.1/2"	P3TFA2B9FAN	160	576	339	P3TKA00ES9F
1.1/2"	P3TFA2B9GAN	220	792	466	P3TKA00ES9G
2"	P3TFA2C9HAN	330	1188	699	P3TKA00ES9H
2.1/2"	P3TFA2D9JAN	430	1548	911	P3TKA00ES9J
3"	P3TFA2E9KAN	430	1548	911	P3TKA00ES9J
2.1/2"	P3TFA2D9KAN	620	2232	1314	P3TKA00ES9K
3"	P3TFA2E9KAN	620	2232	1314	P3TKA00ES9K

Correction factors

Line pressure bar g	psi g	Correction factor
1	15	0.38
2	29	0.53
3	44	0.65
4	58	0.76
5	73	0.85
6	87	0.93
7	100	1.00
8	116	1.07
9	131	1.13
10	145	1.19
11	160	1.25
12	174	1.31
13	189	1.36
14	203	1.41
15	218	1.46
16	232	1.51

Filter selection example

To find the correction factor for 8.5 bar g (122psi g) =

$$\sqrt{\frac{\text{System Operating Pressure}}{\text{Nominal Pressure}}} = \sqrt{\frac{8.5 \text{ bar g}}{7 \text{ bar g}}} = 1.10$$

Selecting a filter model to match a system flow rate and pressure.

Example: System flow 1050 m³/hr at a pressure of 8.5 bar g

1. Obtain pressure correction factor from table or calculate factor using method shown. Correction factor for 8.5 bar g = 1.10
2. Divide system flow by correction factor to give equivalent flow rate at 7 bar g
1050m³/hr ÷ 1.10 = 955 m³/hr (at 7 bar g)
3. Select a filter model from the above table with a flow rate above or equal to 955 m³/hr. Filter model selected : P3TFA2C9HAN
4. Select pipe connection & Thread type System uses 2" piping and BSP threads: Model P3TFA2C9HAN

1 µm Filtration

Technical data

Filter Grade	Drain type	Max operating pressure		Max recommended operating temp.		Min recommended operating temp.	
		bar g	psi g	°C	°F	°C	°F
1 micron	Auto	16	232	80°C	176°F	1.5°C	35°F

Weights and dimensions

Optional Accessories

Port Size	Part Number	A		B		C		D		E		F		G		Weight		Modular Connection Kit	Wall Mounting Bracket Kit
		mm	ins	mm	ins	mm	ins	mm	ins	mm	ins	mm	ins	mm	ins	kg	lbs		
1/4"	P3TFA229AAN	76.0	3.0	181.5	7.2	153.0	6.0	18.0	0.71	24.5	0.96	30.0	1.18	52.0	2.05	0.4	0.9	P3TKA00CBA	P3TKA00MWA
3/8"	P3TFA239BAN	97.5	3.8	235.0	9.3	201.0	7.9	20.5	0.81	25.5	1.00	40.0	1.57	60.0	2.36	1.0	2.2	P3TKA00CBB	P3TKA00MWB
1/2"	P3TFA249CAN	97.5	3.8	235.0	9.3	201.0	7.9	20.5	0.81	25.5	1.00	40.0	1.57	60.0	2.36	1.0	2.2	P3TKA00CBB	P3TKA00MWB
3/4"	P3TFA269DAN	129.0	5.1	275.0	10.8	232.5	9.2	23.0	0.91	28.0	1.10	60.0	2.36	68.0	2.68	2.2	4.8	P3TKA00CBD	P3TKA00MWD
1"	P3TFA289EAN	129.0	5.1	364.5	14.3	322.0	12.7	23.0	0.91	28.0	1.10	60.0	2.36	68.0	2.68	2.6	5.7	P3TKA00CBD	P3TKA00MWD
1.1/4"	P3TFA2A9EAN	129.0	5.1	364.5	14.3	322.0	12.7	23.0	0.91	28.0	1.10	60.0	2.36	68.0	2.68	2.6	5.7	P3TKA00CBD	P3TKA00MWD
1.1/2"	P3TFA2B9FAN	170.0	6.7	432.5	17.0	382.5	15.1	32.0	1.26	39.0	1.54	84.0	3.31	92.0	3.62	4.5	9.9	P3TKA00CBF	P3TKA00MWF
1.1/2"	P3TFA2B9GAN	170.0	6.7	524.5	20.6	474.5	18.7	32.0	1.26	39.0	1.54	84.0	3.31	92.0	3.62	5.3	11.6	P3TKA00CBF	P3TKA00MWF
2"	P3TFA2C9HAN	170.0	6.7	524.5	20.6	474.5	18.7	32.0	1.26	39.0	1.54	84.0	3.31	92.0	3.62	5.3	11.6	P3TKA00CBF	P3TKA00MWF
2.1/2"	P3TFA2D9JAN	205.0	8.1	641.5	25.3	581.5	22.9	35.5	1.40	42.5	1.67	100.0	3.94	135.0	5.31	10.0	22.0	P3TKA00CBJ	P3TKA00MWJ
3"	P3TFA2E9JAN	205.0	8.1	641.5	25.3	581.5	22.9	35.5	1.40	42.5	1.67	100.0	3.94	135.0	5.31	10.0	22.0	P3TKA00CBJ	P3TKA00MWJ
2.1/2"	P3TFA2D9KAN	205.0	8.1	832.0	32.8	772.0	30.4	35.5	1.40	42.5	1.67	100.0	3.94	135.0	5.31	12.0	26.4	P3TKA00CBJ	P3TKA00MWJ
3"	P3TFA2E9KAN	205.0	8.1	832.0	32.8	772.0	30.4	35.5	1.40	42.5	1.67	100.0	3.94	135.0	5.31	12.0	26.4	P3TKA00CBJ	P3TKA00MWJ

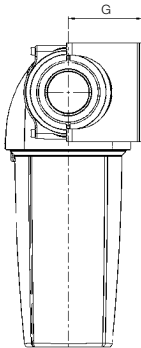
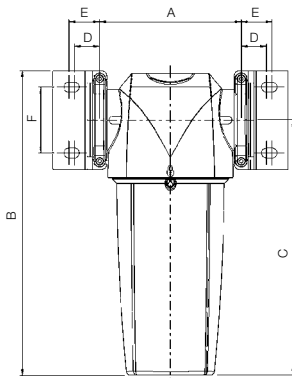

DPI Kit

P3TKA00RQ

Incident Monitor

Used to indicate premature high differential pressure. Indicator can be retrofitted to existing housings without depressurising the system.



Wall Mounting Bracket Kit

Mounting brackets provide additional support to filters installed in flexible piping systems or OEM equipment.



Modular Connection Kit

Fixing clamp allows quick and simple connection of multiple filter housings.

Drain Kits

Auto drain P3TKA00DA

Manual drain P3TKA00DM

Oil Vapour Removal Filter

Filtration Grade

Filtration type	Oil vapour removal
Particle removal (inc water & oil aerosols)	N/A
Max remaining oil content at 21°C	0.003 mg/m ³ 0.003 ppm(w)
Filter efficiency	N/A
Test methods used	ISO 8573.5
ISO 12500-1 Inlet Challenge concentration	N/A
Initial dry differential pressure	<200 mbar (3psi)
Initial saturated differential pressure	N/A
Change element every	When oil vapour is detected
Precede with filtration grade	0.01 micron Moduflex Coalescer filter



Product selection

Stated flows are for operation at 7 bar (g) with reference to 20°C, 1 bar (a), 0% relative water vapour pressure. For flows at other pressures apply the correction factors shown.

Port Size	Part Number	dm ³ /s	m ³ /hr	cfm	Oil vapour removal Replacement Element Kit
1/4"	P3TFA22AAMN	10	36	21	P3TKA00ESAA
3/8"	P3TFA23ABMN	20	72	42	P3TKA00ESAB
1/2"	P3TFA24ACMN	30	108	64	P3TKA00ESAC
3/4"	P3TFA26ADMN	60	216	127	P3TKA00ESAD
1"	P3TFA28AEMN	110	396	233	P3TKA00ESAE
1.1/4"	P3TFA2AAEMN	110	396	233	P3TKA00ESAE
1.1/2"	P3TFA2BAFMN	160	576	339	P3TKA00ESAF
1.1/2"	P3TFA2BAGMN	220	792	466	P3TKA00ESAG
2"	P3TFA2CAHMN	330	1188	699	P3TKA00ESAH
2.1/2"	P3TFA2DAJMN	430	1548	911	P3TKA00ESAJ
3"	P3TFA2EAJMN	430	1548	911	P3TKA00ESAJ
2.1/2"	P3TFA2DAKMN	620	2232	1314	P3TKA00ESAK
3"	P3TFA2EAKMN	620	2232	1314	P3TKA00ESAK

Correction factors

Line pressure bar g	psi g	Correction factor
1	15	0.38
2	29	0.53
3	44	0.65
4	58	0.76
5	73	0.85
6	87	0.93
7	100	1.00
8	116	1.07
9	131	1.13
10	145	1.19
11	160	1.25
12	174	1.31
13	189	1.36
14	203	1.41
15	218	1.46
16	232	1.51
17	247	1.56
18	261	1.60
19	275	1.65
20	290	1.70

To find the correction factor for 8.5 bar g (122psi g) =

$$= \sqrt{\frac{\text{System Operating Pressure}}{\text{Nominal Pressure}}} = \sqrt{\frac{8.5 \text{ bar g}}{7 \text{ bar g}}} = 1.10$$

Filter selection example

Selecting a filter model to match a system flow rate and pressure.

Example: System flow 1050 m³/hr at a pressure of 8.5 bar g

1. Obtain pressure correction factor from table or calculate factor using method shown. Correction factor for 8.5 bar g = 1.10
2. Divide system flow by correction factor to give equivalent flow rate at 7 bar g
1050m³/hr ÷ 1.10 = 955 m³/hr (at 7 bar g)
3. Select a filter model from the above table with a flow rate above or equal to 955 m³/hr. Filter model selected : P3TFA2CAHMN
4. Select pipe connection & Thread type System uses 2" piping and BSP threads: Model P3TFA2CAHMN

Oil Vapour Removal Filter

Technical data

Filter Grade	Drain type	Max operating pressure		Max recommended operating temp.		Min recommended operating temp.	
		bar g	psi g				
Oil vapour removal	Manual	20	290	100°C	212°F	1.5°C	35°F

Weights and dimensions

Optional Accessories

Port Size	Part Number	A		B		C		D		E		F		G		Weight		Modular Connection Kit	Wall Mounting Bracket Kit
		mm	ins	mm	ins	mm	ins	mm	ins	mm	ins	mm	ins	mm	ins	kg	lbs		
1/4"	P3TFA22AAMN	76.0	3.0	181.5	7.2	153.0	6.0	18.0	0.71	24.5	0.96	30.0	1.18	52.0	2.05	0.4	0.9	P3TKA00CBA	P3TKA00MWA
3/8"	P3TFA23ABMN	97.5	3.8	235.0	9.3	201.0	7.9	20.5	0.81	25.5	1.00	40.0	1.57	60.0	2.36	1.0	2.2	P3TKA00CBB	P3TKA00MWB
1/2"	P3TFA24ACMN	97.5	3.8	235.0	9.3	201.0	7.9	20.5	0.81	25.5	1.00	40.0	1.57	60.0	2.36	1.0	2.2	P3TKA00CBB	P3TKA00MWB
3/4"	P3TFA26ADMN	129.0	5.1	275.0	10.8	232.5	9.2	23.0	0.91	28.0	1.10	60.0	2.36	68.0	2.68	2.2	4.8	P3TKA00CBD	P3TKA00MWD
1"	P3TFA28AEMN	129.0	5.1	364.5	14.3	322.0	12.7	23.0	0.91	28.0	1.10	60.0	2.36	68.0	2.68	2.6	5.7	P3TKA00CBD	P3TKA00MWD
1.1/4"	P3TFA2AAEMN	129.0	5.1	364.5	14.3	322.0	12.7	23.0	0.91	28.0	1.10	60.0	2.36	68.0	2.68	2.6	5.7	P3TKA00CBD	P3TKA00MWD
1.1/2"	P3TFA2BAFMN	170.0	6.7	432.5	17.0	382.5	15.1	32.0	1.26	39.0	1.54	84.0	3.31	92.0	3.62	4.5	9.9	P3TKA00CBF	P3TKA00MWF
1.1/2"	P3TFA2BAGMN	170.0	6.7	524.5	20.6	474.5	18.7	32.0	1.26	39.0	1.54	84.0	3.31	92.0	3.62	5.3	11.6	P3TKA00CBF	P3TKA00MWF
2"	P3TFA2CAHMN	170.0	6.7	524.5	20.6	474.5	18.7	32.0	1.26	39.0	1.54	84.0	3.31	92.0	3.62	5.3	11.6	P3TKA00CBF	P3TKA00MWF
2.1/2"	P3TFA2DAJMN	205.0	8.1	641.5	25.3	581.5	22.9	35.5	1.40	42.5	1.67	100.0	3.94	135.0	5.31	10.0	22.0	P3TKA00CBJ	P3TKA00MWJ
3"	P3TFA2EAJMN	205.0	8.1	641.5	25.3	581.5	22.9	35.5	1.40	42.5	1.67	100.0	3.94	135.0	5.31	10.0	22.0	P3TKA00CBJ	P3TKA00MWJ
2.1/2"	P3TFA2DAKMN	205.0	8.1	832.0	32.8	772.0	30.4	35.5	1.40	42.5	1.67	100.0	3.94	135.0	5.31	12.0	26.4	P3TKA00CBJ	P3TKA00MWJ
3"	P3TFA2EAKMN	205.0	8.1	832.0	32.8	772.0	30.4	35.5	1.40	42.5	1.67	100.0	3.94	135.0	5.31	12.0	26.4	P3TKA00CBJ	P3TKA00MWJ

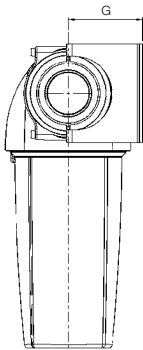
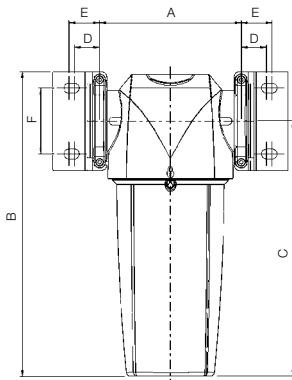

Modular Connection Kit

Fixing clamp allows quick and simple connection of multiple filter housings.



Wall Mounting Bracket Kit

Mounting brackets provide additional support to filters installed in flexible piping systems or OEM equipment.

Drain Kits

Auto drain **P3TKA00DA**

Manual drain **P3TKA00DM**

High Efficiency Bulk Liquid Removal

- Tested in accordance with ISO 8573.9
- Performance independently verified by Lloyds Register
- High liquid removal efficiencies at all flow conditions
- Low pressure losses for low operational costs
- Multiple port sizes for a given flow rate provides increased flexibility during installation
- Suitable for variable flow compressors
- Works with all types of compressor and compressor condensate
- Low maintenance
- 10 Year Housing Guarantee



Typical Applications

- Bulk liquid removal at any point in a compressed air system
- Protection of refrigeration and adsorption dryer pre-filtration
- Liquid removal from compressor inter-coolers / after-coolers
- Liquid separation within refrigeration dryers

Product selection

Stated flows are for operation at 7 bar (g) with reference to 20°C, 1 bar (a), 0% relative water vapour pressure.

Port Size	Part Number	dm³/s	m³/hr	cfm	Max operating pressure		Max Operating temperature		Min Operating temperature		Line pressure		Correction factor
					bar g	psi g			bar g	psi g			
1/4"	P3TFA22WAAN	10	36	21	16	232	80 C	176 F	1.5 C	35 F	1	15	0.25
3/8"	P3TFA23WBAN	40	144	85	16	232	80 C	176 F	1.5 C	35 F	2	29	0.38
1/2"	P3TFA24WCAN	40	144	85	16	232	80 C	176 F	1.5 C	35 F	3	44	0.50
3/4"	P3TFA26WDAN	110	396	233	16	232	80 C	176 F	1.5 C	35 F	4	58	0.63
1"	P3TFA28WEAN	110	396	233	16	232	80 C	176 F	1.5 C	35 F	5	73	0.75
1.1/4"	P3TFA2AWFAN	350	1260	742	16	232	80 C	176 F	1.5 C	35 F	6	87	0.88
1.1/2"	P3TFA2BWWGAN	350	1260	742	16	232	80 C	176 F	1.5 C	35 F	7	100	1.00
2"	P3TFA2CWHAN	350	1260	742	16	232	80 C	176 F	1.5 C	35 F	8	116	1.06
2.1/2"	P3TFA2DWWKAN	800	2880	1695	16	232	80 C	176 F	1.5 C	35 F	9	131	1.12
3"	P3TFA2EWWKAN	800	2880	1695	16	232	80 C	176 F	1.5 C	35 F	10	145	1.17
											11	160	1.22
											12	174	1.27
											13	189	1.32
											14	203	1.37
											15	218	1.41
											16	232	1.46

Correction factors

Filter selection example

Selecting a Water Separator model to match a system flow rate and pressure.

Example: System flow 1050 m³/hr at a pressure of 8 bar g

1. Obtain pressure correction factor from table.
Correction factor for 8 bar g = 1.06
2. Divide system flow by correction factor to give equivalent flow rate at 7 bar g
1050m³/hr ÷ 1.06 = 984 m³/hr (at 7 bar g)
3. Select a filter model from the above table with a flow rate above or equal to 984 m³/hr. Suitable Water Separator models : P3TFA2AWFAN
P3TFA2AWGAN
P3TFA2AWHAN
4. Select pipe connection & Thread type
System uses 1.1/2" piping and BSP threads: Model P3TFA2BWWGAN

To find the correction factor for 8 bar g =

$$\sqrt{\frac{\text{System Operating Pressure}}{\text{Nominal Pressure}}} = \sqrt{\frac{8 \text{ bar g}}{7 \text{ bar g}}} = 1.06$$

High Efficiency Bulk Liquid Removal

Separation Efficiency

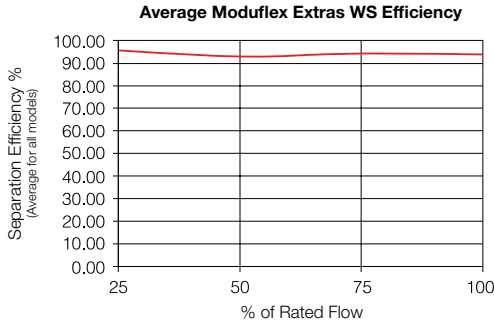

Tested with an inlet challenge concentration of 33ml/m3hr and in accordance with ISO 8573.9. Performance shown is an average for all models in range. Individual model performance available on request.

Weights and dimensions

Optional Accessories

Port Size	Part Number	A		B		C		D		E		F		G		Weight		Modular Connection Kit	Wall Mounting Bracket Kit
		mm	ins	mm	ins	mm	ins	mm	ins	mm	ins	mm	ins	mm	ins	kg	lbs		
1/4"	P3TFA22WAAN	76.0	3.0	181.5	7.2	153.0	6.0	18.0	0.71	24.5	0.96	30.0	1.18	52.0	2.05	0.4	0.9	P3TKA00CBA	P3TKA00MWA
3/8"	P3TFA23WBAN	97.5	3.8	235.0	9.3	201.0	7.9	20.5	0.81	25.5	1.00	40.0	1.57	60.0	2.36	1.0	2.2	P3TKA00CBB	P3TKA00MWB
1/2"	P3TFA24WCAN	97.5	3.8	235.0	9.3	201.0	7.9	20.5	0.81	25.5	1.00	40.0	1.57	60.0	2.36	1.0	2.2	P3TKA00CBB	P3TKA00MWB
3/4"	P3TFA26WDAN	129.0	5.1	275.0	10.8	232.5	9.2	23.0	0.91	28.0	1.10	60.0	2.36	68.0	2.68	2.2	4.8	P3TKA00CBD	P3TKA00MWD
1"	P3TFA28WEAN	129.0	5.1	364.5	14.3	322.0	12.7	23.0	0.91	28.0	1.10	60.0	2.36	68.0	2.68	2.6	5.7	P3TKA00CBD	P3TKA00MWD
1.1/4"	P3TFA2BWFAN	170.0	6.7	432.5	17.0	382.5	15.1	32.0	1.26	39.0	1.54	84.0	3.31	92.0	3.62	4.5	9.9	P3TKA00CBF	P3TKA00MWF
1.1/2"	P3TFA2BWGAN	170.0	6.7	524.5	20.6	474.5	18.7	32.0	1.26	39.0	1.54	84.0	3.31	92.0	3.62	5.3	11.6	P3TKA00CBF	P3TKA00MWF
2"	P3TFA2CWHAN	170.0	6.7	524.5	20.6	474.5	18.7	32.0	1.26	39.0	1.54	84.0	3.31	92.0	3.62	5.3	11.6	P3TKA00CBF	P3TKA00MWF
2.1/2"	P3TFA2DWKAN	205.0	8.1	832.0	32.8	772.0	30.4	35.5	1.40	42.5	1.67	100.0	3.94	135.0	5.31	12.0	26.4	P3TKA00CBJ	P3TKA00MWJ
3"	P3TFA2EWKAN	205.0	8.1	832.0	32.8	772.0	30.4	35.5	1.40	42.5	1.67	100.0	3.94	135.0	5.31	12.0	26.4	P3TKA00CBJ	P3TKA00MWJ

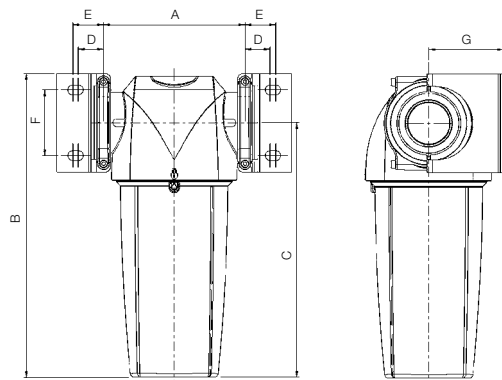

Modular Connection Kit

Fixing clamp allows quick and simple connection of multiple filter housings.



Wall Mounting Bracket Kit

Mounting brackets provide additional support to filters installed in flexible piping systems or OEM equipment.

ISO 8573 - Compressed air quality standards

ISO 8573 is the group of International standards relating to the quality of compressed air and consists of nine separate parts. Part 1 specifies the quality requirements of the compressed air and parts 2 - 9 specify the methods of testing for a range of contaminants.

ISO 8573.1 : 2001 is the primary document used from the ISO 8573 series and it is this document which allows the user to specify the air quality or purity required at key points in a compressed air system.

Within ISO 8573.1 : 2001 purity levels for the main contaminants are shown in separate tables, however for ease of use, this document combines all three into one easy to understand table.

Purity Class	Solid Particulate					Water		Oil
	Maximum number of particles per m ³			Particle Size	Concentration	Vapour	Liquid	Total oil (aerosol, liquid and vapour)
	0.1 - 0.5 micron	0.5 - 1 micron	1 - 5 micron	micron	mg/m ³	Pressure Dewpoint	g/m ³	mg/m ³
0	*	*	*	*	*	-	-	*
1	100	1	0	-	-	-70°C	-	0.01
2	100,000	1,000	10	-	-	-40°C	-	0.1
3	-	10,000	500	-	-	-20°C	-	1
4	-	-	1,000	-	-	+3°C	-	5
5	-	-	20,000	-	-	+7°C	-	-
6	-	-	-	5	5	+10°C	-	-
7	-	-	-	40	10	-	0.5	-
8	-	-	-	-	-	-	5	-
9	-	-	-	-	-	-	10	-

* As specified by the equipment user or supplier

Specifying air purity in accordance with ISO 8573.1 : 2001

When specifying the purity of air required, the standard must always be referenced, followed by the purity class selected for each contaminant (a different purity class can be selected for each contaminant if required). An example of how to write an air quality specification is shown below :

ISO 8573.1 : 2001 Class 1.2.1 (Example)

ISO8573.1 : 2001 refers to the standard document and its revision, the three digits refer to the purity classifications selected for solid particulate, water and total oil. Selecting an air purity class of 1.2.1 would specify the following air quality when operating at the standard's reference conditions:

Class 1 Particulate

In each cubic metre of compressed air, no more than 100 particles in the 0.1 - 0.5 micron size range are allowed

In each cubic metre of compressed air, no more than 1 particle in the 0.5 - 1 micron size range is allowed

In each cubic metre of compressed air, no particles in the 1 - 5 micron size range are allowed

Class 2 Water

A pressure dewpoint of -40°C or better is required and no liquid water is allowed.

Class 1 Oil

In each cubic metre of compressed air, not more than 0.01mg of oil is allowed. This is a combined level for both oil aerosol and oil vapour.

Cost effective system design

To achieve the stringent air quality levels required for today's modern production facilities, a careful approach to system design, commissioning and operation must be employed. Treatment at one point alone is not enough and it is highly recommended that the compressed air is treated prior to entry into the distribution system to a quality level suitable for protecting air receivers and distribution piping.

The following table highlights the Moduflex Extras filtration and drying products required to achieve each air purity classification shown in ISO 8573.1 : 2001.

Point of use purification should also be employed, with specific attention being focused on the application and the level of air quality required. This approach to system design ensures that air is not "over treated" and provides the most cost effective solution to high quality compressed air.

ISO 8573.1:2001 Class	Solid Particulate	Water Vapour	Total Oil (Aerosol Liquid & Vapour)
1	Coalescing Grade 1µm filter + Grade 0.01µm filter + Sterile filter	Moduflex Adsorption Dryer -70°C PDP	Coalescing Grade 0.01µm filter + Grade 1µm filter + Vapour removal filter
2	Coalescing Grade 1µm filter + Grade 0.01µm filter	Moduflex Adsorption Dryer -40°C PDP	Coalescing Grade 0.01µm filter + Grade 1µm filter
3	Coalescing Grade 1µm filter		Coalescing Grade 1µm filter



Moduflex Dry Air System

Totally clean and dry compressed air

Moduflex Dry Air System

The Problem

Compressed air is an essential power source that is widely used throughout industry. This safe, powerful and reliable utility can be the most important part of your production process.

However, your compressed air will contain water, dirt, wear particles and even degraded lubricating oil which all mix together to form an unwanted condensate. This condensate often acidic, rapidly wears tools and pneumatic machinery, blocks valves and orifices causing high maintenance and costly air leaks. It also corrodes piping systems and can bring your production process to an extremely expensive standstill!

The use of high efficiency compressed air filters fitted with condensate drains will remove the oil, water and dirt particles to eliminate the abrasive sludge in the compressed air system.

In many cases this action alone is not enough, as modern production systems and processes demand an even higher level of air quality. Where required, "point of use" desiccant air dryers can provide the correct air quality, without the need for drying the complete compressed air installation, which can be both costly and totally unnecessary.



The Efficient Solution

The Parker Moduflex Dry Air System range of desiccant air dryers, offers the user uncompromised performance from a dedicated "point of use" Clean Dry Air system. It is easy to install and will transform an ordinary process into a highly reliable and efficient production operation.

The Moduflex Dry Air System has been designed with "quick change" filter, dryer combi-cartridges and in-line air connections to facilitate easy maintenance.

The Moduflex Dry Air System totally cleans and dries compressed air down to -40°C (-40°F) pressure dewpoint.

For critical applications, a pressure dewpoint of -70°C (-100°F) is achievable.

The principles of the Moduflex Dry Air System are based upon well proven concepts which embody true innovation and excellent value for money with technically superior yet simple design, while leading the way in compressed air drying.





Prevents unnecessary downtime.

Increases product output by reducing plant downtime.

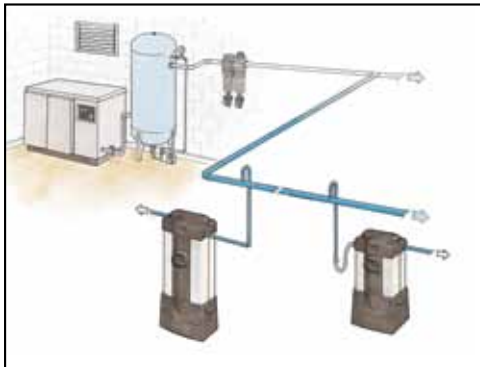

Easy desiccant cartridge replacement



Seven models in range

The Benefits are obvious

- **Point Of Use Application.**
Bringing Clean Dry Air just where you need it.
- **Approved to International Standards**
Designed in accordance with ASME VIII Div.1, approved to CSA/UL/CRN and fully CE Marked (PED, EMC, LVD) as standard.
- **Simple to install**
Flexible installation utilising the multiple in-line inlet & outlet connection ports.
- **Compact and lightweight.**
Can be Floor, Bench or Wall/Canopy mounted.
- **Very Quiet Operation.**
Noise level less than 70dB(A).
- **Can be installed almost anywhere.**
IP66 / NEMA 4 protection as standard.
- **Audible alarm.**
Indicating Service interval for optimal performance.
- **Simple & easy to maintain.**
A 100% service can be achieved insitu in under 15 minutes due to the quick release top cap arrangement, which does NOT require the inlet / outlet ports to be disconnected as with traditional systems.

The Moduflex Dry Air System, is the reliable, cost effective and flexible way to provide Clean Dry Air exactly where needed.

Features

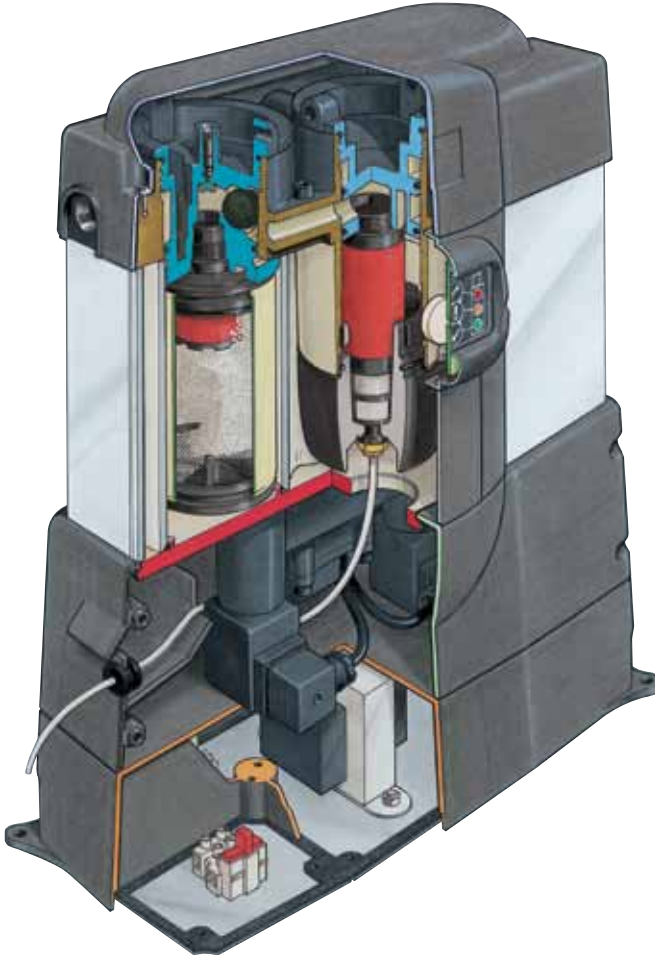

ISO7000 inlet & outlet symbols cast into the top cover ensure correct piping installation.

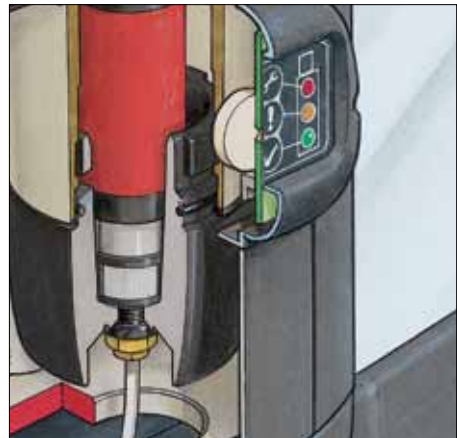

Integral 0.01µm high efficiency filter.

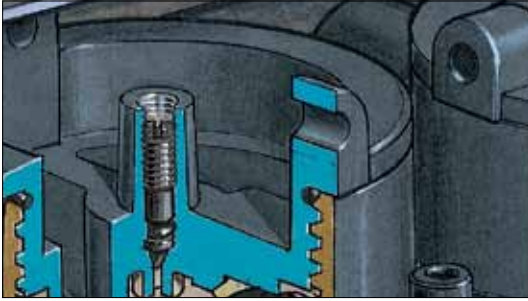

Top End Repressurisation – ensuring uninterrupted compressed air at all times.

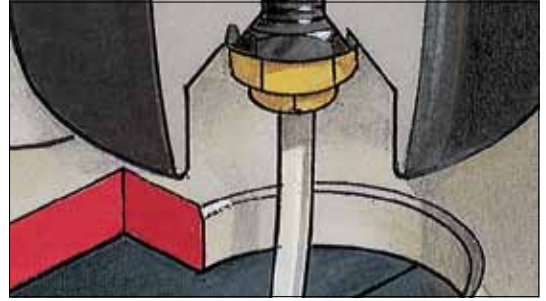

Positive removal of prefilter condensate by piping away for remote collection.

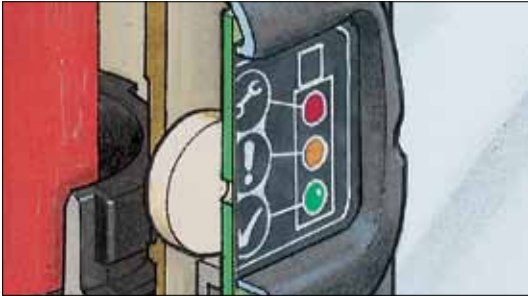

Electronic display providing high visibility LED indication with an internal audible alarm.



Patented high tensile extruded aluminium column with twin drying chambers.



Alarm reset facility to cancel the audible alarm for 24 hours while replacement components are sourced.

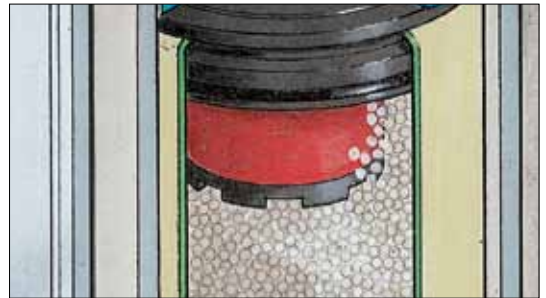

One Combi-Cartridge per column containing DRYFIL® MS desiccant and a 1µm particulate filter.

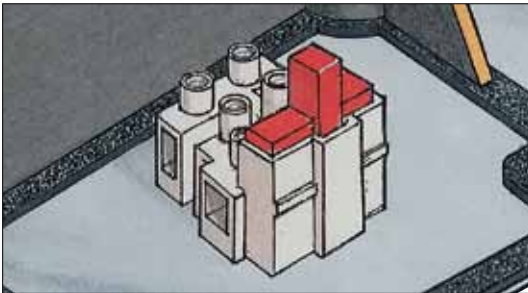

Easy access to electronic control box for mains connection.

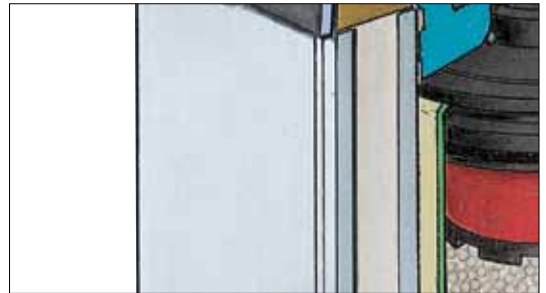

Corrosion protected by alocrom and epoxy painting.

Optional Features

- For totally quiet operation, the regeneration exhaust air can be positively piped away.
- Remote indication provides a warning of the dryers need for servicing. (Audible alarm not included)
- Wall mounting kit for vertically securing the dryer to a wall or canopy.



Tilt mounting kit facilitates easy cartridge replacement

A 45° tilt, wall mounting kit is also available for vertically securing the dryer to a wall, canopy or inside a customers product where access to the top of the dryer is restricted.

- In conditions of limited access, the electronic control box (base) can be detached and relocated remotely from the dryer.



Electronic control box can be remotely located

Product Applications

The Moduflex Dry Air System will benefit users who have a specific need for Clean Dry Air (CDA) directly after a compressor, or for a particular application where the air is critical to the operating process or end product.



Moduflex Dry Air System installed to supply control air for a CNC machining centre

Typical Applications:

- Computer Numerical Control (CNC) Machines
- Co-ordinate Measuring Machines
- Laboratories
- Lasers
- Packaging Machines
- Instrumentation
- Processing equipment
- Conveying Machines

Operation

1

Compressed air enters the integral pre-filter and passes into the left hand chamber (Column A) where the air is dried before passing to the application.

A small amount of dry purge air is used to regenerate the right hand chamber (Column B) which is wet, using the PSA (Pressure Swing Adsorption) method of regeneration, venting the saturated air to atmosphere under pressure. The same regeneration air is also used to "back flush" the integral filter to prolong its working life.

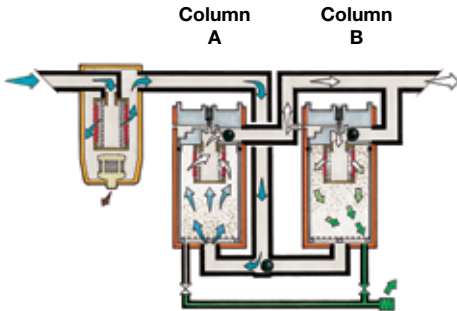

Service Indication Sequence & Alarm

During operation, The Moduflex Dry Air System Power On (yellow) LED and Check (Green) LED indicators will illuminate, remaining in this configuration for 11500 hours. At this time, the Warning (Yellow) LED will illuminate and cancel the Check (Green) LED. This signals the user to order service replacement components at the optimum time.

500 hours later (a total of 12000 hours from initial start up) the Service (Red) LED will illuminate and cancel the Warning (Yellow) LED, the Audible Alarm housed inside the display will sound intermittently (every 6 seconds) drawing attention to the need for a service.



2

Prior to changeover, the right hand chamber (Column B) enters repressurisation where the exhaust valve is closed to allow pressure to increase.

This process ensures a smooth uninterrupted changeover, preventing the loss of any system pressure, before the process repeats itself.

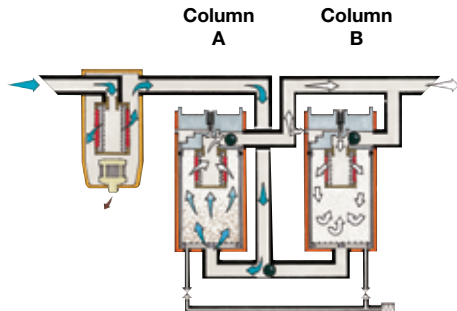

Selection Criteria

To correctly select the dryer best suited for your application, the following details are required to ensure optimum performance and trouble free operation.

- **Maximum Inlet Flow.**
- **Minimum Inlet Pressure.**
- **Maximum Inlet Temperature.**

Once these operating parameters have been established, you can select the most economical Moduflex Dry Air System for your application.



Technical Specifications

Flow Range:	85 L/min to 567 L/min at 7 bar
Minimum Operating Pressure:	4 bar
Maximum Operating Pressure:	12 bar
Minimum Operating Temperature:	1.5°C
Maximum Inlet Temperature:	50°C
Noise Level (Average):	≤ 70dB(A)
Pressure Dewpoint	(Standard): -40°C pdp
	(Optional): -70°C pdp
Standard Electrical Supply:	230/1ph/50Hz (Tolerance +/- 10%)
	115/1ph/60Hz (Tolerance +/- 10%)
Controls:	Electronic Control Timer
Inlet Connections:	G3/8
Outlet Connections:	G3/8

Ordering Information

P3 T J A 3 A N

Thread type	
1	BSP
9	NPT

Size
1
2
3
4
5
6
7

Supply Voltage	
A	(230 V AC)
C	(24 V AC)
J	(110 V AC)

NOTE: BOLD OPTIONS ARE STANDARD.

Standard nominal flow rate qnN (NL/min) at pressure dew point -40°C

Model	Port Size	Max inlet temperature	Inlet Pressure (bar)								
			4	5	6	7	8	9	10	11	12
P3TJA13A1AN	3/8"	20°C	53	63	75	85	82	92	100	110	118
	3/8"	35°C	33	47	66	85	80	99	118	142	165
	3/8"	40°C	32	46	64	82	77	97	114	138	160
	3/8"	45°C	29	42	58	75	70	87	104	125	145
	3/8"	50°C	24	35	48	62	58	73	86	103	142
P3TJA13A2AN	3/8"	20°C	90	107	125	142	137	153	167	183	198
	3/8"	35°C	57	80	110	142	133	165	197	236	277
	3/8"	40°C	55	78	106	138	129	161	190	229	269
	3/8"	45°C	50	71	96	125	116	145	174	209	244
	3/8"	50°C	41	59	80	104	97	121	144	172	238
P3TJA13A3AN	3/8"	20°C	143	170	200	277	220	245	267	292	317
	3/8"	35°C	90	128	176	227	213	265	315	377	444
	3/8"	40°C	87	124	170	220	207	257	304	365	431
	3/8"	45°C	79	112	154	200	187	233	278	333	390
	3/8"	50°C	66	94	128	166	156	194	230	274	380
P3TJA13A4AN	3/8"	20°C	178	213	250	283	275	307	335	365	397
	3/8"	35°C	112	160	220	283	267	332	395	471	556
	3/8"	40°C	109	155	213	275	259	322	382	456	540
	3/8"	45°C	98	141	193	249	234	292	348	416	488
	3/8"	50°C	82	117	160	207	195	243	288	343	476
P3TJA13A5AN	3/8"	20°C	232	277	323	368	357	398	435	475	515
	3/8"	35°C	146	208	284	368	346	430	513	613	721
	3/8"	40°C	142	202	275	357	336	418	496	594	700
	3/8"	45°C	128	183	249	324	303	378	452	542	633
	3/8"	50°C	107	152	207	269	253	314	374	447	618
P3TJA13A6AN	3/8"	20°C	268	318	373	425	412	458	502	548	595
	3/8"	35°C	169	239	328	425	400	495	592	707	833
	3/8"	40°C	163	232	317	412	387	481	572	685	809
	3/8"	45°C	147	210	287	374	350	435	522	625	732
	3/8"	50°C	123	175	239	310	293	362	432	515	714
P3TJA13A7AN	3/8"	20°C	357	425	498	567	550	612	668	732	793
	3/8"	35°C	225	319	438	567	534	661	788	944	1110
	3/8"	40°C	218	310	423	550	517	643	762	915	1078
	3/8"	45°C	196	281	383	499	468	581	695	834	975
	3/8"	50°C	164	234	319	414	391	483	574	688	952

Weights and Dimensions

Model	Dimensions mm (ins) A	Weight kg (lbs)
P3TJA13A1AN	422 (16.6)	11 (24.2)
P3TJA13A2AN	500 (19.7)	13 (28.7)
P3TJA13A3AN	616 (24.2)	16 (35.3)
P3TJA13A4AN	692 (27.2)	18 (39.7)
P3TJA13A5AN	847 (33.3)	20 (44.1)
P3TJA13A6AN	906 (35.7)	23 (50.7)
P3TJA13A7AN	1098 (43.2)	28 (61.7)

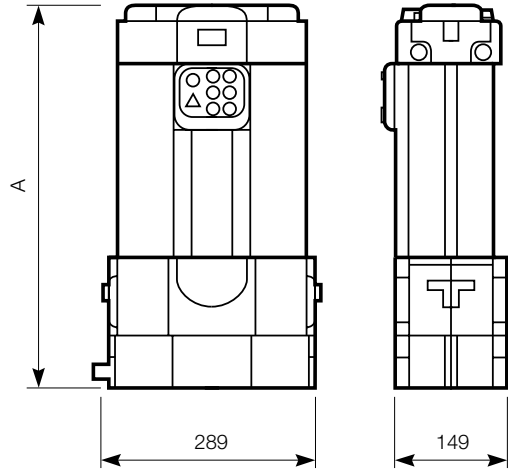

Service Kits

Model	Service Kit
P3TJA13A1AN	P3TKA00JA1
P3TJA13A2AN	P3TKA00JA2
P3TJA13A3AN	P3TKA00JA3
P3TJA13A4AN	P3TKA00JA4
P3TJA13A5AN	P3TKA00JA5
P3TJA13A6AN	P3TKA00JA6
P3TJA13A7AN	P3TKA00JA7

Mounting Kits

Description	Kit
Fixed Wall Mounting Bracket	P3TKA00MJ
45° Tilt Wall Mounting Bracket	P3TKA00MK

ISO 8573 - Compressed air quality standards

ISO 8573 is the group of International standards relating to the quality of compressed air and consists of nine separate parts. Part 1 specifies the quality requirements of the compressed air and parts 2 - 9 specify the methods of testing for a range of contaminants.

ISO 8573.1 : 2001 is the primary document used from the ISO 8573 series and it is this document which allows the user to specify the air quality or purity required at key points in a compressed air system.

Within ISO 8573.1 : 2001 purity levels for the main contaminants are shown in separate tables, however for ease of use, this document combines all three into one easy to understand table.

Purity Class	Solid Particulate					Water		Oil
	Maximum number of particles per m ³			Particle Size	Concentration	Vapour	Liquid	Total oil (aerosol, liquid and vapour)
	0.1 - 0.5 micron	0.5 - 1 micron	1 - 5 micron	micron	mg/m ³	Pressure Dewpoint	g/m ³	mg/m ³
0	*	*	*	*	*	*	*	*
1	100	1	0	-	-	-70°C	-	0.01
2	100,000	1,000	10	-	-	-40°C	-	0.1
3	-	10,000	500	-	-	-20°C	-	1
4	-	-	1,000	-	-	+3°C	-	5
5	-	-	20,000	-	-	+7°C	-	-
6	-	-	-	5	5	+10°C	-	-
7	-	-	-	40	10	-	0,5	-
8	-	-	-	-	-	-	5	-
9	-	-	-	-	-	-	10	-

* As specified by the equipment user or supplier

Specifying air purity in accordance with ISO 8573.1 : 2001

When specifying the purity of air required, the standard must always be referenced, followed by the purity class selected for each contaminant (a different purity class can be selected for each contaminant if required). An example of how to write an air quality specification is shown below :

ISO 8573.1 : 2001 Class 1.2.1 (Example)

ISO8573.1 : 2001 refers to the standard document and its revision, the three digits refer to the purity classifications selected for solid particulate, water and total oil. Selecting an air purity class of 1.2.1 would specify the following air quality when operating at the standard's reference conditions:

Class 1 Particulate

In each cubic metre of compressed air, no more than 100 particles in the 0.1 - 0.5 micron size range are allowed
 In each cubic metre of compressed air, no more than 1 particle in the 0.5 - 1 micron size range is allowed
 In each cubic metre of compressed air, no particles in the 1 - 5 micron size range are allowed

Class 2 Water

A pressure dewpoint of -40°C or better is required and no liquid water is allowed.

Class 1 Oil

In each cubic metre of compressed air, not more than 0.01mg of oil is allowed. This is a combined level for both oil aerosol and oil vapour.

Cost effective system design

To achieve the stringent air quality levels required for today's modern production facilities, a careful approach to system design, commissioning and operation must be employed. Treatment at one point alone is not enough and it is highly recommended that the compressed air is treated prior to entry into the distribution system to a quality level suitable for protecting air receivers and distribution piping.

The following table highlights the Moduflex Extras filtration and drying products required to achieve each air purity classification shown in ISO 8573.1 : 2001.

Point of use purification should also be employed, with specific attention being focused on the application and the level of air quality required. This approach to system design ensures that air is not "over treated" and provides the most cost effective solution to high quality compressed air.

ISO 8573.1:2001 Class	Solid Particulate	Water Vapour	Total Oil (Aerosol Liquid & Vapour)
1	Coalescing Grade 1µm filter + Grade 0.01µm filter + Sterile filter	Moduflex Adsorption Dryer -70°C PDP	Coalescing Grade 0.01µm filter + Grade 1µm filter + Vapour removal filter
2	Coalescing Grade 1µm filter + Grade 0.01µm filter	Moduflex Adsorption Dryer -40°C PDP	Coalescing Grade 0.01µm filter + Grade 1µm filter
3	Coalescing Grade 1µm filter		Coalescing Grade 1µm filter



Moduflex AirGuard Protection System

Airfuse - protection of personnel, machinery and equipment

Protect your most important assets: your employees and their equipment!

The AirGuard offers simple but efficient protection to pneumatic systems in the event of a broken compressed-air hose or pipe. The air supply is immediately shut off by the AirGuard, should the volume of air exceed a set value. This "value" is factory preset and is set to allow normal air consumption when using air tools.

Should the air consumption exceeds the set value, e.g. the air line is severed, then the internal piston instantly shuts off the main flow. An integral bleed hole allows some air to flow though. This enables the line pressure to automatically reset the AirGuard once the main line break is repaired.

Management Responsibility:

It is the duty of management to ensure a safe working environment for their employees and that the equipment complies with the **Machinery Directive EN983** or **"PUWER"** (the Provision and Use of Work Equipment Regulations)

EU Standard EN983-1996 (5.3.4.3.2) currently states:

"Failure of flexible hose assemblies and plastic piping: If the failure of a flexible hose assembly constitutes a whiplash hazard or a fluid ejection hazard, it shall be restrained or shielded".

Complies with the 2009 ISO4414 (5.4.5.11.1)

"When failure of a hose assembly of plastic piping constitutes a whiplash hazard, it shall be restrained or shielded by suitable means and/or an air fuse for compressed air shall be mounted".

Function:

(P) is the inlet. Air passes the piston (1) and continues through the seat (3). The air flow, passing the piston, is slowed down by means of length wise grooves on the outer side of the piston. If the flow is too high, the air cannot pass the piston quickly enough, and the piston is forced against the spring (2) and towards the seat. The maximum flow is shown in the graph. If the value indicated is exceeded e.g. if the hose suddenly breaks - the air supply is automatically shut off. An integral bleed hole allows some air to flow though. This enables the line pressure to automatically reset the AirGuard once the main line break is repaired.

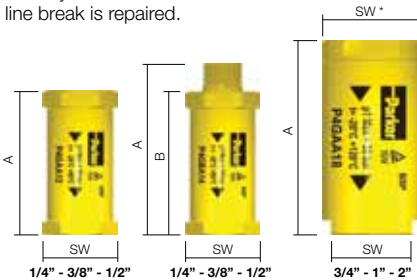
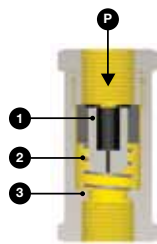

Special Applications

Stainless Steel AirGuard available in 1/2" size

Some branches of industry with a high hazard potential, such as chemical and pharmaceutical as well as clean room and offshore technologies place extremely high demands on both the safety of their employees and the protection of their facilities. Compressed air is typically used as an energy transfer medium in these industries and is no means without its dangers: compressed air hoses can rupture or burst, as can fixed pipes. This may expose personnel working in such areas to extreme hazards as well as potential damage to expensive facilities and costly production downtime.



Technical Data and Ordering Information

Thread connection BSP	dimensions (mm)			Weight (g)	Maximum inlet pressure	Temperature range	Material	P1 inlet thread	P2 outlet thread	Order Code
	A	B	SW							
1/4"	48	-	22	30	18 bar (255 PSIG)	-20°C to 80°C (-4°F to 176°F)	Housing: aluminium Piston: polyoxy- methylene	female	female	P4GAA12
1/4"	58	49	22	36				male	female	P4GBA12
3/8"	59	-	27	58				female	female	P4GAA13
3/8"	71	59	27	62				male	female	P4GBA13
1/2"	65	-	30	78				female	female	P4GAA14
1/2"	80	65	30	85				male	female	P4GBA14
1/2"	62	-	28	132	35 bar (500 PSIG)	-20°C to 120°C (-4°F to 248°F)	Housing: stainless steel Piston: polyoxy- methylene	female	female	P4GCA14
3/4"	76	-	30 / 36*	107			Housing: aluminium Piston: aluminium	female	female	P4GAA16
1"	100	-	41 / 50*	300			female	female	P4GAA18	
2"	130	-	70 / 80*	775			female	female	P4GAA1C	

Note: NPT version available on request - 1/4" high flow version available on request.

How to select the optimal size of an AirGuard

Information based on an inlet pressure of 7 bar

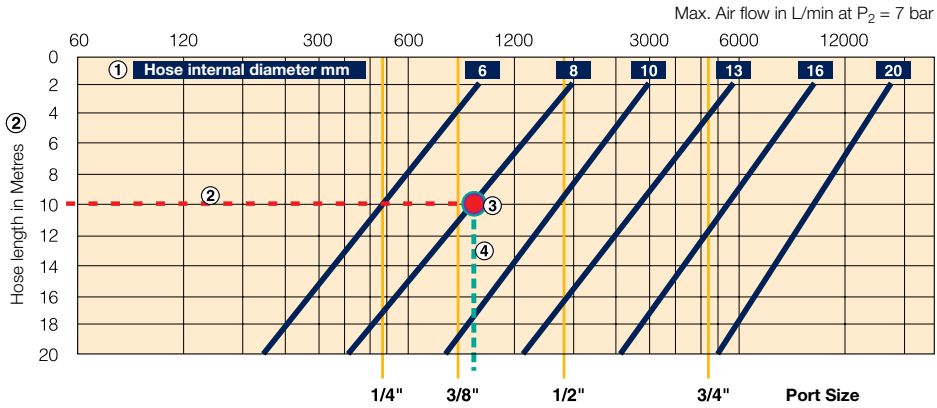

- Determine the internal diameter of the hose, tube or pipe being used ① (see specification Hose-internal Diameter in blue box, blue diagonal line).
- Determine the length of the hose, tube or pipe ② (Hose length in meters).
- Define the intersection of point a and b, and mark a vertical line downwards. ③ - ④ (In the example the red/green dot and the green dashed line).
- The next vertical yellow line, left of the intersection line ④ (example: green dashed) tells the correct AirGuard size (in inches).
- Important: Every flow value to the right of the respective vertical line (yellow) would activate the AirGuard in case of a bursting hose, pipe or tube. All AirGuard sizes right of the intersection line (green) are too big and will not close up.
- Example:** Which air fuse should be used for a hose, pipe or tube bearing 8 mm inner diameter and 10 meters of length - follow the 10 meter line (red ②) to the intersection point (red/green dot ③). Now the next left yellow line marks the correct size.
- Result:** The correct size in our example is the AirGuard 3/8"

Closing Flow Graphs

1/4", 3/8" and 1/2" flow rates

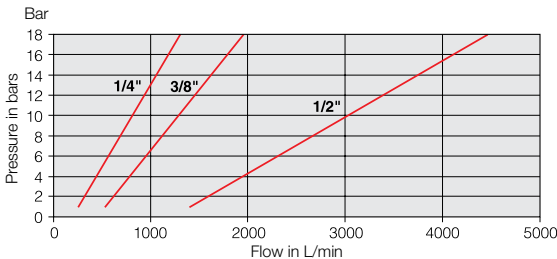

3/4", 1" and 2" flow rates

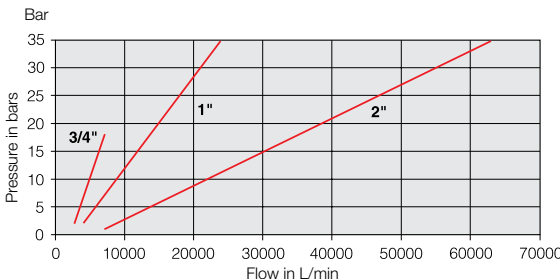

Dimensioning of compressed air hoses and equipment

Connection Size	Hose length 0 to 10 meters			Hose length 10 to 20 meters		
	Inner diameter Minimum mm	Minimum pressure bar	Flow at 6 bar l/min	Inner diameter minimum	Minimum pressure bar	Flow at 6 bar l/min
1/4"	7	4	480	8	4	480
3/8"	10	4	1100	12	4	1100
1/2"	12	4	2000	14	4	2000
3/4"	18	4	3800	20	4	3800
1"	24	4	6500	26	4	6500
2"	45	4	16000	50	4	16000

If the pressure is lower than stated in the table, a hose with a larger internal diameter must be used.

To select the correct size AirGuard, the pneumatic tool or equipment must have a maximum flow requirement to the left of the red line.

e.g.: 15 bar @20000 L/m = 2" size AirGuard
8 bar @1000 L/m = 3/8" size AirGuard



Miniature FRL Series

14F Filters - Miniature

Features

- Excellent water removal efficiency.
- Unique deflector plate that creates swirling of the air stream ensuring maximum water and dirt separation.
- 5 micron element standard.
- High Flow: 1/8" – 10 dm³/s
1/4" – 11 dm³/s

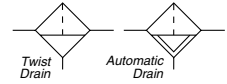
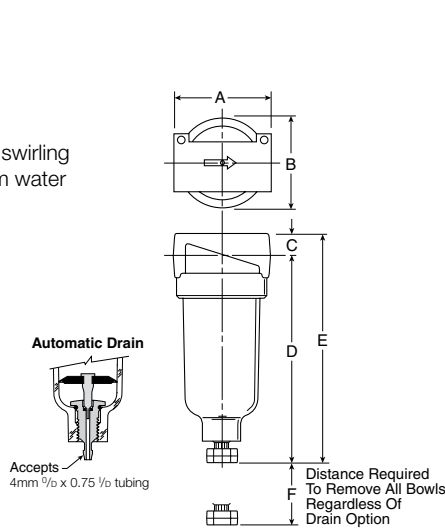

Port Size	BSPP	
	Twist Drain	Automatic Pulse Drain
Poly Bowl		
1/8"	14F01BB1	14F05BB1
1/4"	14F11BB1	14F15BB1

14F Filter Dimensions (mm)		
A 43	B 39	C 10
D 97	D† 99	E 107
E† 108	F 41	

Standard part numbers shown.

For other models refer to ordering information below.

§ dm³/s = 6.2 bar inlet and 0.3 bar pressure drop.

† With Automatic Pulse Drain.

Ordering Information

1 4 F 1 1 B B 1

	Port size	Bowl options	Elements
0	1/8 Inch	1 Twist drain	B 5 Micron
1	1/4 Inch	5 Automatic pulse drain	

	Port type
Blank	NPT
1	BSPP

NOTE: BOLD OPTIONS ARE STANDARD.

Technical Information

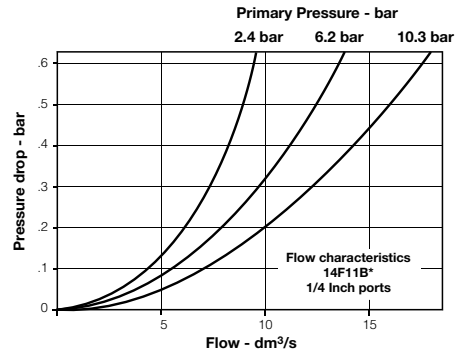
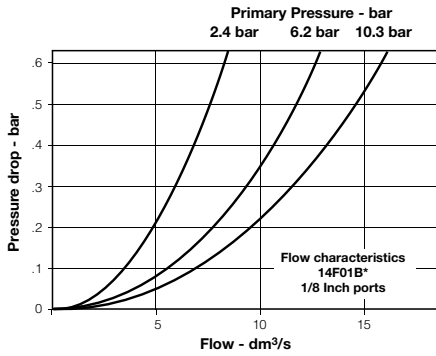

14F Filter Kits & Accessories

Bowl Kits –

Poly Bowl –

- Automatic Pulse Drain PS408P
- Twist Drain PS404P

Filter Element Kits –

- 5 Micron PS403P

- Mounting Bracket Kit** PS417BP

Specifications

Automatic Pulse Drain Tube Barb 4mm^{OD} x 0.75 1/8

Bowl Capacity 30 cm³

Port Threads 1/8, 1/4 Inch

Pressure & Temperature Ratings –

Polycarbonate Bowl 0 to 10.3 bar
 0°C to 52°C

Automatic Pulse Drain 0.7 to 10.3 bar
 at 52°C or less

Weight 180 g

Materials of Construction

Body Zinc Bowl Transparent Polycarbonate

Deflector, Element Holder & Baffle Plastic

Drains –

Twist Drain –

- Body & Stem Plastic
- Seals Nitrile

Automatic Pulse Drain –

- Piston & Seals Nitrile
- Stem, Seat, Adaptor & Washers Aluminum

Filter Elements –

5 Micron (Standard) Plastic

Seals Nitrile

10F Coalescing Filters - Miniature

Features

- Removes liquid aerosols and sub-micron particles.
- Liquids gravitate to the bottom of the element and will not re-enter the airstream.
- Oil free air for critical applications, such as air gauging and pneumatic instrumentation and controls.
- 99.97% DOP efficiency.
- High Flow: Grade 6 Element
 - 1/8" – 8 dm³/s
 - 1/4" – 9 dm³/s

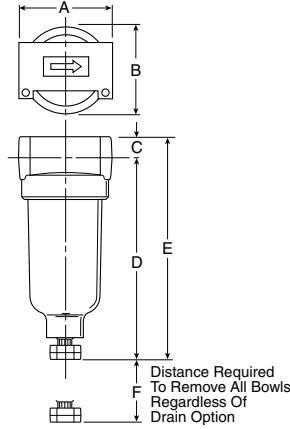
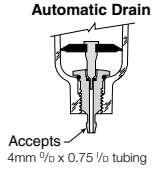

Port Size	BSPP	
	Twist Drain	Automatic Pulse Drain
Poly Bowl		
1/8"	10F01ED1	10F05ED1
1/4"	10F11ED1	10F15ED1

Standard part numbers shown.

§ dm³/s = 6.2 bar inlet and 0.3 bar pressure drop.

10F Coalescing Filter Dimensions (mm)		
A	B	C
43	39,6	10
D	D [†]	E
97	93	107
E [†]	F	
103	41	

[†] With Automatic Pulse Drain.

Ordering Information

1
0
F
1
1
E
D
-

	Port size
0	1/8 Inch
1	1/4 Inch

	Bowl options
1	Twist drain
5	Automatic pulse drain

	Elements
E	0.01 um

	Port type
Blank	NPT
1	BSPP

NOTE: BOLD OPTIONS ARE STANDARD.

Technical Information

Grade 6

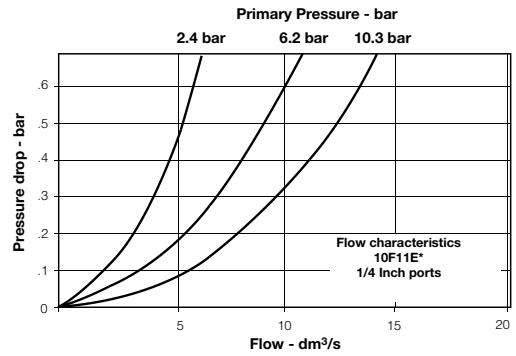
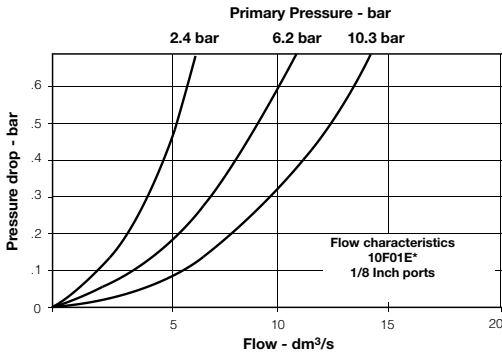

10F Coalescing Filter Kits & Accessories

- Bowl Kits –**
Poly Bowl –Automatic Pulse Drain PS408P
 Twist Drain PS404P
Filter Element Kits – 0.01 µm PS446P
Mounting Bracket Kit PS417BP

Specifications

- Automatic Pulse Drain Tube Barb** 4mm^o/_b x 0.75 1/_b
Bowl Capacity 30cm³
Operation –
 Normal Operating Pressure Drop 0.1 bar
 Maximum Recommended Pressure Drop 0.7 bar
 (Element should be replaced)
Port Threads 1/8, 1/4 Inch
Pressure & Temperature Ratings –
 Polycarbonate Bowl – 0 to 10.3 bar
 0°C to 52°C
Weight 180 g

Materials of Construction

- Body** Zinc
Bowls Transparent Polycarbonate
Drains – Twist Drain –
 Body & Stem Plastic
 Seals Nitrile
Automatic Pulse Drain –
 Piston & Seals Nitrile
 Stem, Seat, Adaptor & Washers Aluminum
Element Holder Plastic
Filter Element –
 Borosilicate & felt glass fibers 99.97% DOP efficiency
Seals Nitrile

14R Regulators - Miniature

Features

- Unbalanced poppet standard.
- Solid control piston with lip seal for extended life.
- Non-rising adjusting knob.
- Compact, 73,2mm high by 42mm wide.
- High Flow: 1/8" – 6 dm³/s
1/4" – 7 dm³/s

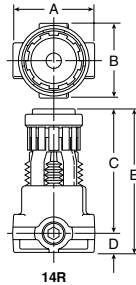
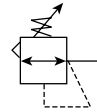

Port Size	8 bar - BSP
Without Gauge	
1/8"	14R013FC1
1/4"	14R113FC1

14R Regulator Dimensions (mm)					
14R	A	B	C	D	E
	42	40	63,5	10	73

Standard part numbers shown bold. For other models refer to ordering information below.

NOTE: 31mm dia. hole required for panel mounting.

§ dm³/s = 6.9 bar inlet, 6.2 bar no flow secondary setting and 0.7 bar pressure drop.

Ordering Information

1 4 R 1 13 F C 1

<table border="1" style="width: 100%; border-collapse: collapse;"> <thead> <tr> <th></th> <th>Port size</th> </tr> </thead> <tbody> <tr> <td style="text-align: center;">0</td> <td>Port size 1/8 Inch pipe 1/8 Inch gauge port</td> </tr> <tr> <td style="text-align: center;">1</td> <td>1/4 Inch pipe 1/8 Inch gauge port</td> </tr> </tbody> </table>		Port size	0	Port size 1/8 Inch pipe 1/8 Inch gauge port	1	1/4 Inch pipe 1/8 Inch gauge port	<table border="1" style="width: 100%; border-collapse: collapse;"> <thead> <tr> <th></th> <th>Pressure range</th> </tr> </thead> <tbody> <tr> <td></td> <td>Without gauge - Yellow knob</td> </tr> <tr> <td style="text-align: center;">10</td> <td>2 bar</td> </tr> <tr> <td style="text-align: center;">11</td> <td>4 bar</td> </tr> <tr> <td style="text-align: center;">13</td> <td>8 bar</td> </tr> </tbody> </table>		Pressure range		Without gauge - Yellow knob	10	2 bar	11	4 bar	13	8 bar	<table border="1" style="width: 100%; border-collapse: collapse;"> <thead> <tr> <th></th> <th>Relief</th> </tr> </thead> <tbody> <tr> <td style="text-align: center;">F</td> <td>Relieving</td> </tr> <tr> <td style="text-align: center;">G</td> <td>Non-Relieving</td> </tr> </tbody> </table>		Relief	F	Relieving	G	Non-Relieving	<table border="1" style="width: 100%; border-collapse: collapse;"> <thead> <tr> <th></th> <th>Port type</th> </tr> </thead> <tbody> <tr> <td></td> <td>Blank NPT</td> </tr> <tr> <td style="text-align: center;">1</td> <td>BSPP</td> </tr> </tbody> </table>		Port type		Blank NPT	1	BSPP
	Port size																														
0	Port size 1/8 Inch pipe 1/8 Inch gauge port																														
1	1/4 Inch pipe 1/8 Inch gauge port																														
	Pressure range																														
	Without gauge - Yellow knob																														
10	2 bar																														
11	4 bar																														
13	8 bar																														
	Relief																														
F	Relieving																														
G	Non-Relieving																														
	Port type																														
	Blank NPT																														
1	BSPP																														

NOTE: BOLD OPTIONS ARE STANDARD.

Technical Information

**Relief and Flow Characteristics
 14R013F***

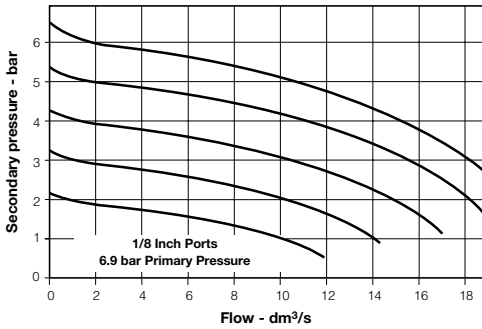

**Relief and Flow Characteristics
 14R113F***

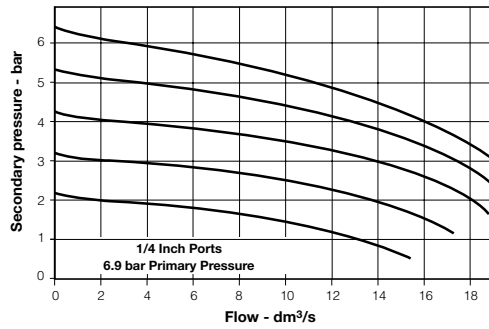

CAUTION:

REGULATOR PRESSURE ADJUSTMENT – The working range of knob adjustment is designed to permit outlet pressures within their full range. Pressure adjustment beyond this range is also possible because the knob is not a limiting device. This is a common characteristic of most industrial regulators, and limiting devices may be obtained only by special design.

For best performance, regulated pressure should always be set by increasing the pressure up to the desired setting.

⚠ WARNING

**Product rupture can cause serious injury.
 Do not connect regulator to bottled gas.
 Do not exceed maximum primary pressure rating.**

14R Regulator Kits & Accessories

- Bonnet Assembly Kit** L01369
- Gauges** – 0 to 2 bar - 1/8.....P3D-KAB1AYN
- 0 to 4 bar - 1/8.....P3D-KAB1ALN
- 0 to 10 bar - 1/8.....P3D-KAB1ANN
- Mounting Bracket Kit (Includes Panel Mount Nut)** PS417BP
- Panel Mount Nuts** – Plastic.....P78652
- Metal.....P01531
- Service Kits** – Non-Relieving..... PS422P
- Relieving..... PS423P

Specifications

- Gauge Ports (2)** 1/8
 (Can be used for Full Flow)
- Port Threads** 1/8, 1/4 Inch
- Pressure & Temperature Ratings** – 0 to 20.7 bar 0°C to 52°C
- Secondary Pressure Ranges** –
- Standard Pressure..... 0 to 8 bar
- Medium Pressure 0 to 4 bar
- Medium Pressure 0 to 2 bar
- Weight** – 14R 140 g

Materials of Construction

- Adjusting Nut** Brass
- Adjusting Stem & Spring** Steel
- Body** Zinc
- Bonnet, Seat, Piston & Valve Poppet** Plastic
- Seals** Nitrile

14E Filter / Regulator - Miniature

Features

- Excellent water removal efficiency.
- Unbalanced poppet standard.
- Solid control piston for extended life.
- Space saving package offers both filter and regulator features in one integral unit.
- Non-rising adjustment knob.
- Two full flow 1/8" gauge ports.
- High Flow: 1/8" – 7 dm³/s[§]
1/4" – 8 dm³/s[§]

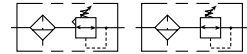
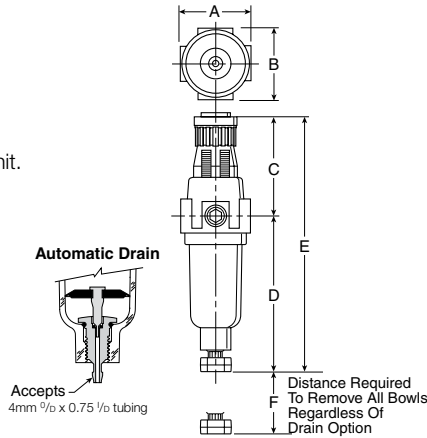

Port Size	8 BAR - BSPP	
	Twist Drain	Automatic Pulse Drain
Poly Bowl [†]		
1/8"	14E01B13FC1	14E05B13FC1
1/4"	14E11B13FC1	14E15B13FC1

14E Filter / Regulator Dimensions (mm)		
A 41	B 40	C 61
D 96	D [†] 92	E 158
E [†] 154	F 41	

Standard part numbers shown. For other models refer to ordering information below.

§ dm³/s = 6.9 bar inlet, 6.2 bar no flow secondary setting and 0.7 bar pressure drop.

NOTE: 31mm hole required for panel mounting.

† With Auto Drain

Ordering Information

1 4 E 1 1 B 13 F C 1

	Port size	Bowl options	Elements	Relief	Port type
0	1/8 Inch	1 Twist drain	B 5 Micron	F Relieving	Blank NPT
1	1/4 Inch	5 Automatic drain		G Non-Relieving	1 BSPP

Pressure range	
	Without gauge - Yellow knob
10	2 bar
11	4 bar
13	8 bar

NOTE: BOLD OPTIONS ARE STANDARD.

Technical Information

**Relief and Flow Characteristics
 14E01B13F***

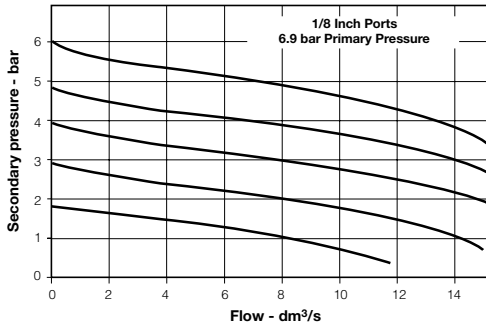

**Relief and Flow Characteristics
 14E11B13F***

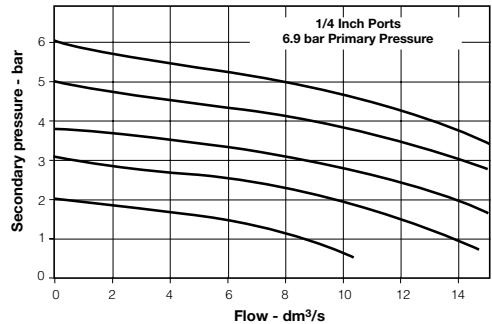

CAUTION:

REGULATOR PRESSURE ADJUSTMENT – The working range of knob adjustment is designed to permit outlet pressures within their full range. Pressure adjustment beyond this range is also possible because the knob is not a limiting device. This is a common characteristic of most industrial regulators, and limiting devices may be obtained only by special design.

For best performance, regulated pressure should always be set by increasing the pressure up to the desired setting.

⚠ WARNING

**Product rupture can cause serious injury.
 Do not exceed maximum primary pressure rating.**

14E Filter / Regulator Kits & Accessories

- Bowl Kits –**
- Poly Bowl – Automatic Drain..... PS408P
- Twist Drain PS404P
- Filter Element Kits – 40 Micron..... PS401P**
- 5 Micron..... PS403P
- Gauges –**
- 0 to 2 bar - 1/8.....P3D-KAB1AYN
- 0 to 4 bar - 1/8.....P3D-KAB1ALN
- 0 to 10 bar - 1/8.....P3D-KAB1ANN
- Mounting Bracket Kit (Includes Panel Mount Nut)PS417BP**
- Panel Mount NutP78652**
- Service Kits – Non-Relieving PS422P**
- Relieving..... PS423P

Specifications

- Automatic Pulse Drain Tube Barb4mm^{OD} x 0.75 1/0**
- Bowl Capacity 30 cm³**
- Gauge Ports (2) (Can be used for Full Flow).....1/8 Inch**
- Port Threads1/8, 1/4 Inch**
- Pressure & Temperature Ratings –**
- Polycarbonate Bowl..... 0 to 10.3 bar, 0°C to 52°C
- Secondary Pressure Ranges –**
- Standard Pressure..... 0 to 8 bar
- Medium Pressure 0 to 2 bar
- Medium Pressure 0 to 4 bar
- Weight 180 g**

Materials of Construction

- Adjusting NutBrass**
- Adjusting Stem & SpringSteel**
- Body..... Zinc**
- Bonnet, Knob, Seat, Piston, Holder & Deflector Plastic**
- Bowl Available – Transparent Polycarbonate**
- Drains – Manual – Twist Type**
- Body & Stem Plastic
- Seals.....Nitrile
- Automatic – Pulse Type**
- Piston & Seals.....Nitrile
- Stem, Seat, Adaptor & Washers.....Aluminum
- Filter Elements – 5 Micron (Standard) Plastic**
- Seals Nitrile**

04L Mist Lubricators - Miniature

Features

- Proportional oil delivery over a wide range of air flows.
- Precision needle valve assures repeatable oil delivery and provides simple adjustment of delivery rate.
- Ideal for low and high flow applications with changing air flow.
- Transparent sight dome for 360° visibility.
- High Flow: 1/8" – 9 dm³/s[§]
1/4" – 10 dm³/s[§]

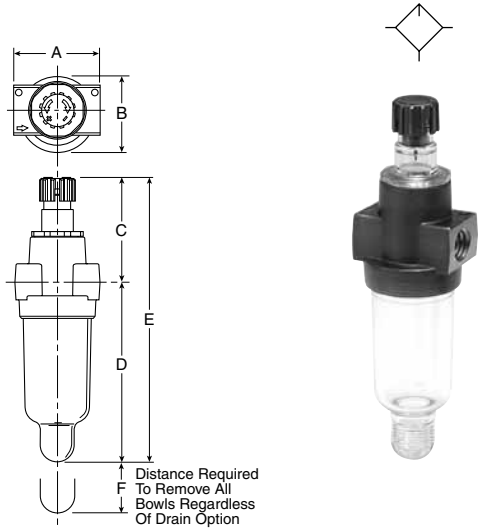

Port Size	BSPB No Drain
Poly Bowl	
1/8"	04L00GB1
1/4"	04L10GB1

04L Lubricator Dimensions (mm)		
A 44	B 40	C 55
D 92	D† 96	E 147
E† 151	F 41	

Standard part numbers shown bold.

For other models refer to ordering information below.

§ dm³/s = 6.2 bar inlet and 0.3 bar pressure drop.

Ordering Information

0
4
L
1
0
G
B
-

Port size	
0	1/8 Inch
1	1/4 Inch

Port type	
Blank	NPT
1	BSPB

NOTE: BOLD OPTIONS ARE STANDARD.

Technical Information

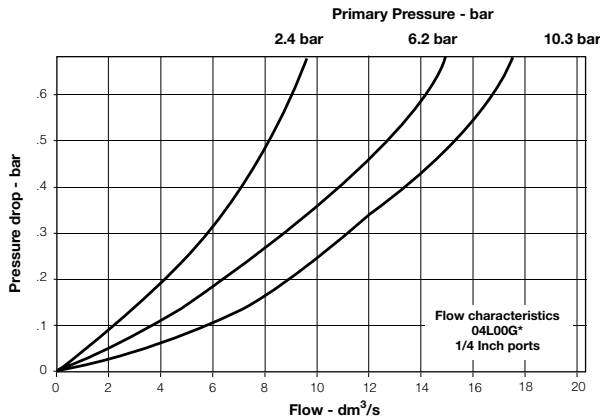
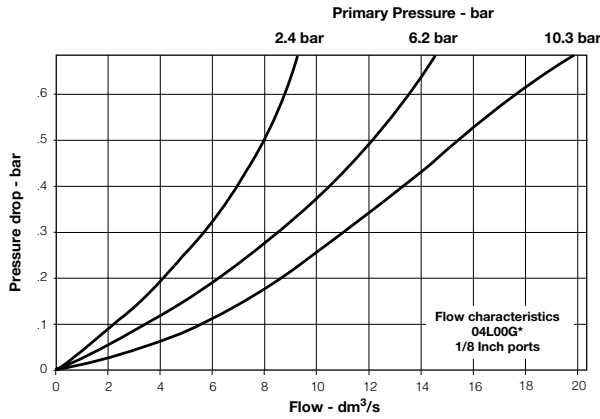

04L Mist Lubricator Kits & Accessories

Bowl Kits –

Poly Bowl – No Drain PS421P

Specifications

Bowl Capacity 30 cm³
 Minimum Flow for Lubrication 0.2 dm³/s at 6.9 bar
 Port Threads 1/8, 1/4 Inch
 Pressure & Temperature Ratings –
 Polycarbonate Bowl – 0 to 10.3 bar
 0°C to 52°C
 Weight 180 g

Materials of Construction

Body Zinc
 Bowls – Transparent Polycarbonate
 Seals Nitrile
 Sight Dome Polycarbonate

Mounting Bracket Kits

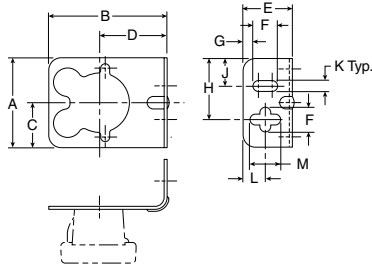

PS417BP
 (Includes Panel Mount Nut)

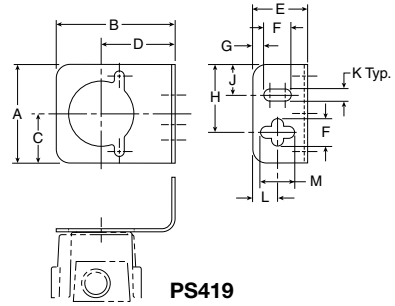

PS419

Dimensions (mm)

A	B	C	D	E	F	G	H	J	K	L	M	Kit
46	60	23	34	25	13	5	31	14	6	11	16	PS417BP (10F, 14F, 14R, 14E)
46	55	23	34	25	13	5	31	14	6	11	16	PS419 (04L)



Stainless Steel FRLs

Air Preparation Units

PF504 Filter – Miniature

Features

- Stainless steel construction handles most corrosive environments
- Fluorocarbon seals standard
- Meets NACE specifications MR-01-75/ISO 15156
- High flow: 1/4" - 10.85 dm³/s[§]
- 1/8" female threaded drain

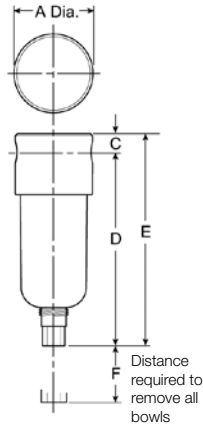
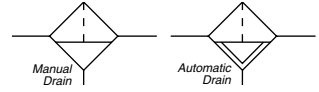

Port Size	BSPB	NPT
	Manual Twist Drain	Manual Twist Drain
1/4"	PF504G02DHSS	PF504-02DHSS

PF504 Filter Dimensions (mm)		
A	C	D
40	8	94
E	F	
102	40	

Standard part numbers shown bold.
 For other models refer to ordering information below.

[§] dm³/s = Flow at 6.2 bar and a 0.3 bar pressure drop.

Ordering Information

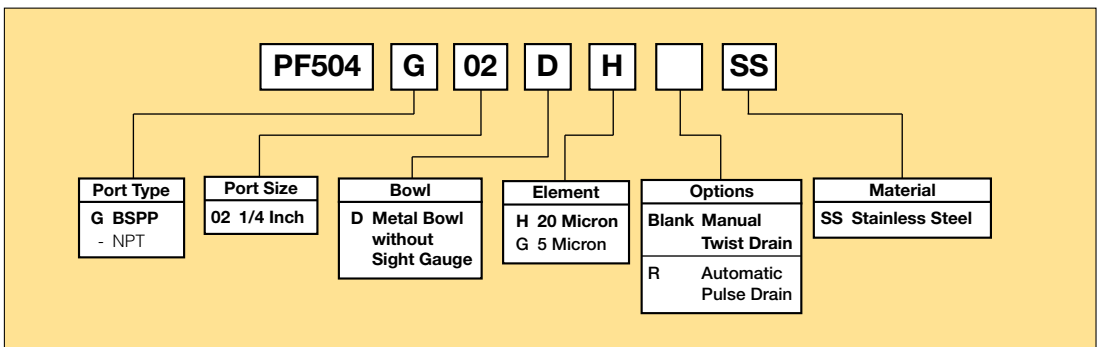

BOLD ITEMS ARE MOST POPULAR.

Technical Specifications – PF504

Operation

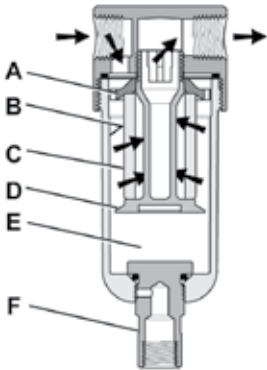

First Stage Filtration:

Air enters at inlet port and flows through deflector plate (A) which causes a swirling action. Liquids and coarse particles are forced to the bowl interior wall (B) by the centrifugal action of the swirling air. They are then carried down the bowl wall by the force of gravity. The baffle (D) separates the lower portion of the bowl into a “quiet zone” (E) where the removed liquid and particles collect, unaffected by the swirling air, and are therefore not reentrained into the flowing air.

Second Stage Filtration:

After liquids and large particles are removed in the first stages of filtration, the air flows through element (C) where smaller particles are filtered out. The filtered air then passes downstream. Collected liquids and particles in the “quiet zone” (E) should be drained before their level reaches a height where they would be reentrained in the flowing air. This can be accomplished by unscrewing the drain valve (F) slightly until the liquid begins to drain.

Technical Information

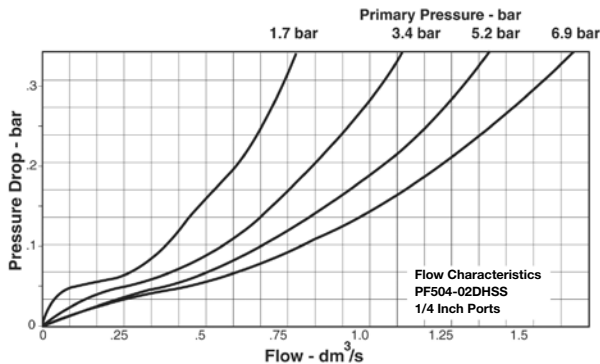

PF504 Filter Kits & Accessories

- Filter Element Kits –**
 - Particulate (5 Micron)EK504VY
 - Particulate (20 Micron)EK504Y
- Drain Kits -**
 - Automatic Pulse Drain.....RK504SY-SS
- Manual Twist Drain –**
 - Small (Old)SA600Y7-1SS
 - Large (New)SAP05481
- Pipe Nipple –**
 - 1/4" NPT 316 Stainless Steel..... 616Y28-SS
 - 1/4" BSPT 316 Stainless Steel.....AC-2SS

Specifications

- Bowl Capacity** 29 cm³
- Filter Rating**20 Micron
- Sump Capacity** 12 cm³
- Port Threads**1/4 Inch

Pressure & Temperature Ratings –

- Manual Twist Drain 0 to 20.7 bar
 -18°C to 82°C
- Auto Pulse Drain..... 0 to 12 bar
 0°C to 66°C

Note: Air must be dry enough to avoid ice formation at temperatures below 2°C.

Weight 274 g

Materials of Construction

- Body**316 Stainless Steel
- Bowls** 316 Stainless Steel
- Deflector**Acetal
- Drain**316 Stainless Steel
- Element Holder**Acetal
- Filter Element**Polyethylene
- Seals** Fluorocarbon

PF501 Coalescing Filter – Miniature



Features

- Stainless steel construction handles most corrosive environments
- Meets NACE specifications MR-01-75/ISO 15156
- High flow: 1/4" - 755 dm³/s[§]
- 1/8" female threaded drain

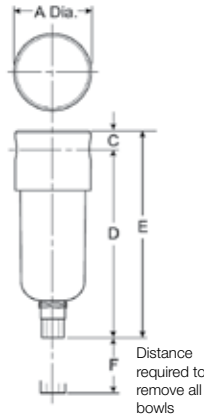

Port Size	BSPP	NPT
	Manual Twist Drain	Manual Twist Drain
1/4"	PF501G02DHSS	PF501-02DHSS

PF501 Coalescing Filter Dimensions (mm)		
A 40	C 8	D 94
E 102	F 40	

Standard part numbers shown bold.
 For other models refer to ordering information below.
 § dm³/s = Flow at 6.2 bar and a 0.3 bar pressure drop.

Ordering Information

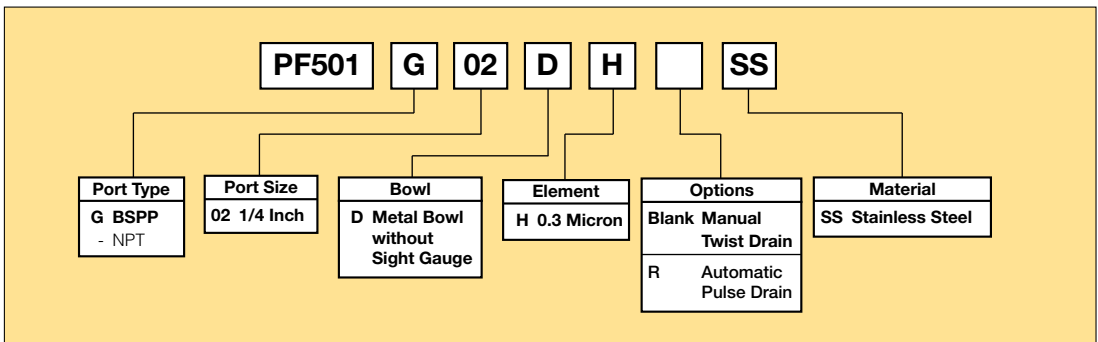

BOLD ITEMS ARE MOST POPULAR.

Technical Specifications – PF501

Operation

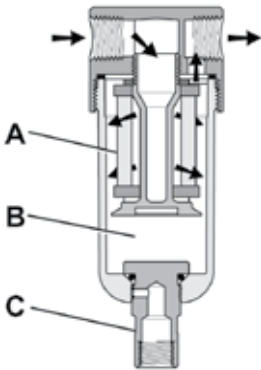

The contaminated air enters the element interior and is forced through a thick membrane (A) of “borosilicate” glass fibers coated with epoxy. Flow then passes through the element, and at this stage 99.97% of the sub micronic particles have been removed from the air stream. The tiny droplets coalesce together and are collected from the filter element by the outer drain layer. The clean, filtered air now passes through and out into the pneumatic system. The air line coalescing filter removes liquid aerosols and sub-micron particulate matter. Collected liquids and particles in the “quiet zone” (B) should be drained before their level reaches a height where they would be reentrained in the flowing air. This can be accomplished by unscrewing the drain valve (C) slightly until the liquid begins to drain.

Technical Information

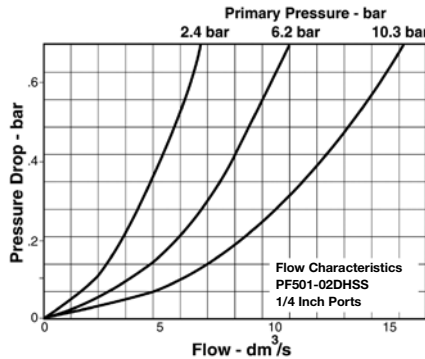

F501 Filter Kits & Accessories

- Filter Element Kits –**
- 0.3 MicronEKF501H
- Drain Kits -**
- Automatic Pulse Drain.....RK504SY-SS
- Manual Twist Drain –**
- Small (Old)SA600Y7-1SS
- Large (New)SAP05481
- Pipe Nipple –**
- 1/4" NPT 316 Stainless Steel..... 616Y28-SS
- 1/4" BSPT 316 Stainless Steel.....AC-2SS

Specifications

- Bowl Capacity** 29 cm³
- Filter Rating** 0.3 Micron
- Port Threads** 1/4 Inch

Pressure & Temperature Ratings –

- Manual Twist Drain 0 to 20.7 bar
 -18°C to 82°C
- Auto Pulse Drain..... 0 to 12 bar
 0°C to 66°C

Note: Air must be dry enough to avoid ice formation at temperatures below 2°C.

- Sump Capacity** 12 cm³
- Weight** 275 g

Materials of Construction

- Body** 316 Stainless Steel
- Bowls** 316 Stainless Steel
- Drain** 316 Stainless Steel
- Element Holder** Acetal
- Filter Element** Borosilicate Fiber
- Seals** Fluorocarbon

PR354, PR364 Regulator – Miniature

Features

- Stainless steel construction handles most corrosive environments
- Large diaphragm to valve area ratio for precise regulation and high flow capacity
- Meets NACE specifications MR-01-75/ISO 15156
- High flow: 1/4" – 5.75 dm³/s[§]

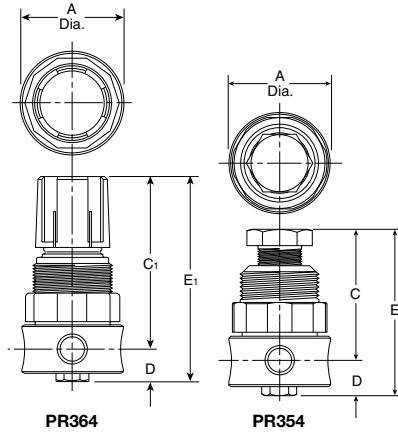

PR364



PR354

Series	Adjustment Type	Port Size	BSPP	NPT
PR364	Knob	1/4"	PR364G02CSS	PR364-02CSS
PR354	All Metal	1/4"	PR354G02CSS	PR354-02CSS

PR354, PR364 Regulator Dimensions (mm)		
A	C	C ₁
40	51	65
D	E	E ₁
13	64	78

Standard part numbers shown bold.

For other models refer to ordering information below.

[§] dm³/s = 7 bar inlet pressure with 5.5 bar set pressure and 1 bar pressure drop.

(mm)
NOTE: 32mm dia. hole required for panel mounting.

⚠ WARNING

**Product rupture can cause serious injury.
Do not connect regulator to bottled gas.
Do not exceed maximum primary pressure rating.**

Ordering Information

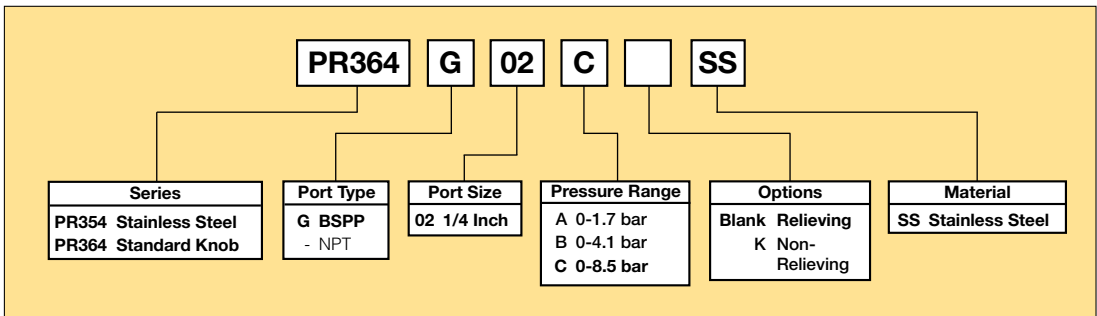

BOLD ITEMS ARE MOST POPULAR.

Technical Specifications – PR354, PR364

Operation

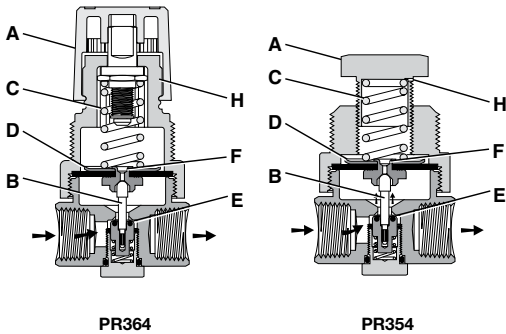

With the adjusting knob (A) turned fully counter-clockwise (no spring load), and pressure supplied to the regulator inlet port, the valve poppet assembly (B) is closed. Turning the adjusting knob clockwise applies a load to control spring (C). This load causes the diaphragm (D) and the valve poppet assembly (B) to move downward allowing flow across the seat area (E) created between the poppet assembly and the seat. Pressure in the downstream line is sensed below the diaphragm (D) and offsets the load of spring (C). As downstream pressure rises, poppet assembly (B) and diaphragm (D) move upward until the area (E) is closed and the load of the spring (C) and pressure under diaphragm (D) are in balance. A reduced outlet pressure has now been obtained, depending on spring load. Creating a demand downstream, such as opening a valve, results in a reduced pressure under the diaphragm (D). The load of control spring (C) now causes the poppet assembly to move downward opening seat area (E) allowing air to flow to meet the downstream demand. The flow of downstream air is metered by the amount of opening (E). Should downstream pressure exceed the desired regulated pressure, the excess pressure will cause the diaphragm (D) to move upward against control spring (C), open vent hole (F), and vent the excess pressure to atmosphere through the hole in the bonnet (H). (This occurs in the relieving type regulator only.)

Technical Information

CAUTION:

REGULATOR PRESSURE ADJUSTMENT –

The working range of knob adjustment is designed to permit outlet pressures within their full range. Pressure adjustment beyond this range is also possible because the knob is not a limiting device. This is a common characteristic of most industrial regulators, and limiting devices may be obtained only by special design.

For best performance, regulated pressure should always be set by increasing the pressure up to the desired setting.

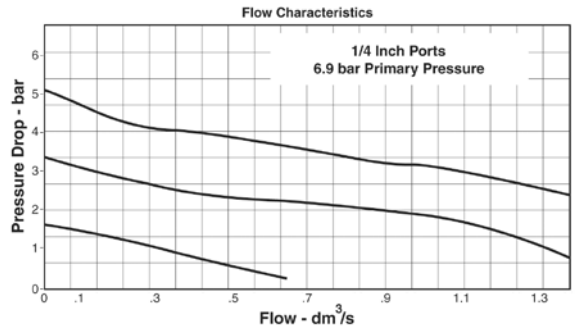

R354, R364 Regulator Kits & Accessories

R354 Bonnet Kit	CKR354YSS
R364 Bonnet Kit (Knob Included)	CKR364YSS
Gauge –	
0 to 10 bar	M1/4G40S-10
Panel Mount Bracket (Stainless)	161X57-SS
Panel Mount Nut –	
Stainless	R05X51SS
Plastic	R05X51-P
Pipe Nipple –	
1/4" NPT 316 Stainless Steel.....	616Y28-SS
1/4" BSPT 316 Stainless Steel.....	AC-2SS
Service Kit –	
Relieving	RKR364YSS
Non-Relieving	RKR364KYSS

Specifications

Gauge Port	1/4 Inch
Operation	Fluorocarbon Diaphragm
Port Threads	1/4 Inch
Pressure & Temperature Ratings –	
PR354.....	20.7 bar -18°C to 82°C
PR364.....	20.7 bar -18°C to 66°C
Note: Air must be dry enough to avoid ice formation at temperatures below 2°C.	
Weight	230 g

Materials of Construction

Adjustment Mechanism / Springs	316 Stainless Steel
Adjusting Knob (PR354)	316 Stainless Steel
Adjusting Knob (PR364)	Polypropylene
Body	316 Stainless Steel
Bonnet (PR354)	316 Stainless Steel
Bonnet (PR364)	Acetal
Bottom Plug	316 Stainless Steel
Poppet	316 Stainless Steel
Seals	Fluorocarbon

PB548, PB558 Filter / Regulator – Miniature

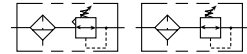

Features

- Stainless steel construction handles most corrosive environments
- Large diaphragm to valve area ratio for precise regulation and high flow capacity
- Meets NACE specifications MR-01-75/ISO 15156.
- High flow: 1/4" – 5.75 dm³/s[§]
- 1/8" female threaded drain

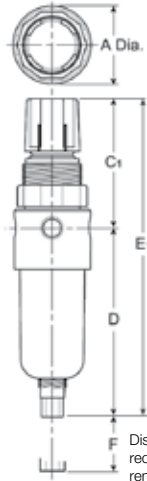

Distance required to remove all bowls

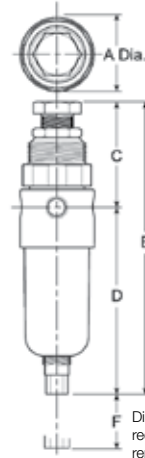

Distance required to remove all bowls



PB548



PB558

Port Size	BSP	NPT
1/4"	PB548G02DHCSS	PB548-02DHCSS
1/4"	PB558G02DHCSS	PB558-02DHCSS

PB548, PB558 Piggyback Dimensions (mm)		
A	C	C ₁
40	55	67
D	E	E ₁
92	78	147
F		
40		

Standard part numbers shown bold.

For other models refer to ordering information below.

[§] dm³/s = 7 bar inlet pressure with 5.5 bar set pressure and 1 bar pressure drop.

⚠ WARNING
<p>Product rupture can cause serious injury. Do not connect regulator to bottled gas. Do not exceed maximum primary pressure rating.</p>

(mm)
NOTE: 32mm dia. hole required for panel mounting.

Ordering Information

PB548							G	02	D	H	C	SS
Series	Port Type	Bowl	Element	Reduced Pressure Range	Options	Material						
PB548 Standard Knob PB558 Stainless Steel	G BSPP - NPT	D Metal Bowl without Sight Gauge	H 20 Micron G 5 Micron	A 0-1.7 bar B 0-4.1 bar C 0-8.5 bar	Blank Relieving K Non-Relieving R Automatic Pulse Drain	SS Stainless Steel						
Port Size												
02 1/4 Inch												

BOLD ITEMS ARE MOST POPULAR.

Technical Specifications – PB548, PB558

Operation

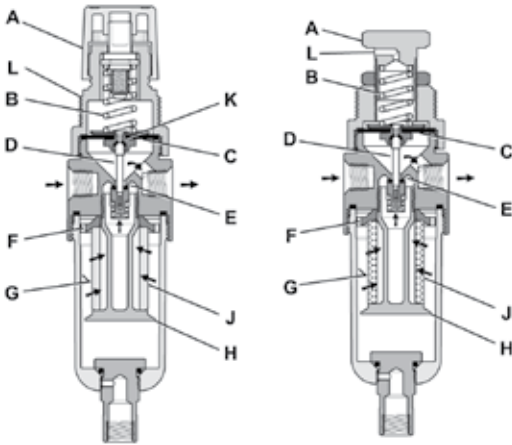

Turning the adjusting knob clockwise applies a load to control spring (B) which forces diaphragm (C) and valve poppet assembly (D) to move downward allowing filtered air to flow through the seat area (E) created between the poppet assembly and the seat. "First stage filtration". Air pressure supplied to the inlet port is directed through deflector plate (F) causing a swirling centrifugal action forcing liquids and coarse particles to the inner bowl wall (G) and down below the lower baffle (H) to the quiet zone. After liquids and large particles are removed in the first stage of filtration "second stage filtration" occurs as air flows through element (J) where smaller particles are filtered out and retained. The air flow now passes through seat area (E) to the outlet port of the unit. Pressure in the downstream line is sensed below the diaphragm (C) and offsets the load of spring (B). When downstream pressure reaches the set-point, poppet valve assembly (D) and diaphragm (C) move upward closing seat area (E). Should downstream pressure exceed the desired regulated pressure, the excess pressure will cause the diaphragm (C) to move upward opening vent hole (K) venting the excess pressure to atmosphere through the hole in the bonnet (L). (This occurs in the standard relieving type filter/regulators only.)

Technical Information

CAUTION:

REGULATOR PRESSURE ADJUSTMENT – The working range of knob adjustment is designed to permit outlet pressures within their full range. Pressure adjustment beyond this range is also possible because the knob is not a limiting device. This is a common characteristic of most industrial regulators, and limiting devices may be obtained only by special design.

For best performance, regulated pressure should always be set by increasing the pressure up to the desired setting.

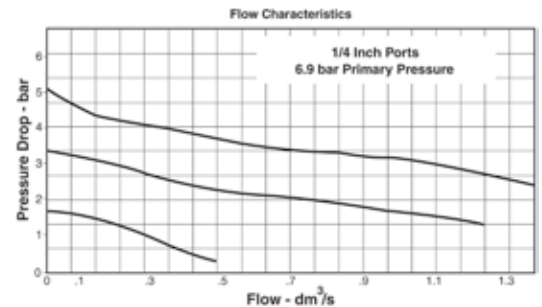

PB548, B558 Regulator Kits & Accessories

Filter Element Kits –	
Particulate (5 Micron)	EK504VY
Particulate (20 Micron)	EK504Y
Gauge –	
0 - 10 bar	M1/4G40S-10
Drain Kits -	
Automatic Pulse Drain	RK504SY-SS
Manual Twist Drain -	
Small (Old)	SA600Y7-1SS
Large (New)	SAP05481
Panel Mount Bracket (Stainless)	161X57-SS
Panel Mount Nut –	
Stainless	R05X51SS
Plastic	R05X51-P
Pipe Nipple –	
1/4" NPT 316 Stainless Steel	616Y28-SS
1/4" BSPT 316 Stainless Steel	AC-2SS
Service Kit –	
Relieving	RK549YSS
Non-Relieving	RK548YSS

Specifications

Bowl Capacity	29 cm ³
Filter Rating	20 Micron
Gauge Port	1/4 Inch
Operation	Fluorocarbon Diaphragm
Port Threads	1/4 Inch
Pressure & Temperature Ratings –	
PB548	20.7 bar max. -18°C to 82°C
PB558	20.7 bar max. -18°C to 82°C
Auto Pulse Drain	0 to 12 bar max. 0°C to 66°C

Note: Air must be dry enough to avoid ice formation at temperatures below 2°C.

Sump Capacity	12 cm ³
Weight	270 g

Materials of Construction

Adjustment Mechanism / Springs	316 Stainless Steel
Body	316 Stainless Steel
Bonnet (PB548)	Acetal
Bonnet (PB558)	316 Stainless Steel
Bottom Plug	316 Stainless Steel
Knob (PB548)	Polypropylene
Knob (PB558)	316 Stainless Steel
Poppet	316 Stainless Steel
Seals	Fluorocarbon

PF10 Filter – Standard

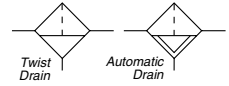

Features

- Stainless steel construction handles most corrosive environments
- Meets NACE specifications MR-01-75/ISO 15156
- High flow: 1/2" - 34 dm³/s[§]
- 1/8" female threaded drain

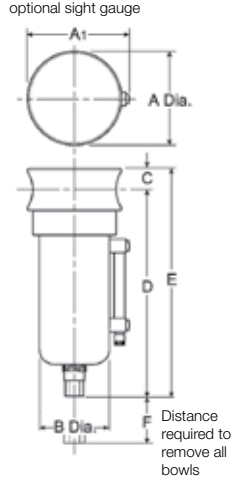

Port Size	BSPP		NPT	
	Manual Twist Drain	Automatic Float Drain	Manual Twist Drain	Automatic Float Drain
1/2"	Metal Bowl Without Sight Gauge			
	PF10G04DJSS	PF10G04DJRSS	PF10-04DJSS	PF10-04DJRSS

PF10 Filter Dimensions (mm)		
A	A1	B
60	64	44
C	D	E
14	127	141
F		
54		

Standard part numbers shown bold.
For other models refer to ordering information below.

[§] dm³/s = Flow at 6.2 bar and a 0.3 bar pressure drop.

(mm)

Ordering Information

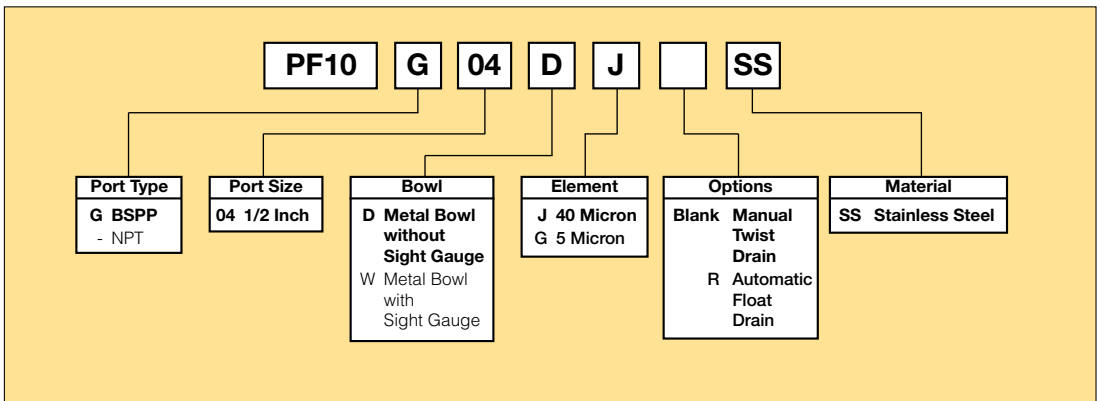

BOLD ITEMS ARE MOST POPULAR.

Technical Specifications – PF10

Operation

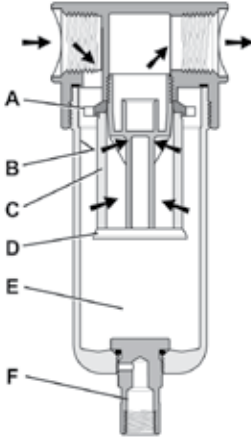

First Stage Filtration:

Air enters at inlet port and flows through deflector plate (A) which causes a swirling action. Liquids and coarse particles are forced to the bowl interior wall (B) by the centrifugal action of the swirling air. They are then carried down the bowl wall by the force of gravity. The baffle (D) separates the lower portion of the bowl into a “quiet zone” (E) where the removed liquid and particles collect, unaffected by the swirling air, and are therefore not reentrained into the flowing air.

Second Stage Filtration:

After liquids and large particles are removed in the first stages of filtration, the air flows through element (C) where smaller particles are filtered out. The filtered air then passes downstream. Collected liquids and particles in the “quiet zone” (E) should be drained before their level reaches a height where they would be reentrained in the flowing air. This can be accomplished by unscrewing the drain valve (F) slightly until the liquid begins to drain.

Technical Information

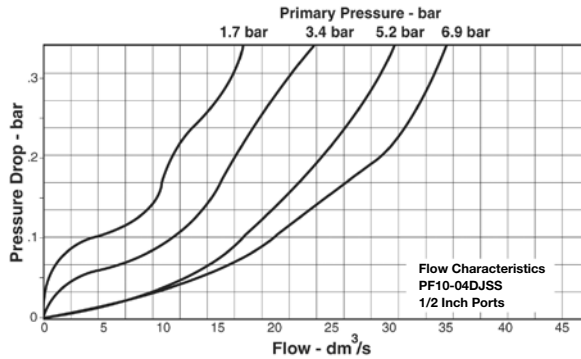

PF10 Filter Kits & Accessories

- Drain Kit –**
- Automatic Float DrainSA10MDSS
 - Manual Twist Drain–
 - Small (Old)SA600Y7-1SS
 - Large (New)SAP05481
- Filter Element Kits –**
- Particulate (40 Micron).....EK55J
 - Particulate (5 Micron).....EK55G
- Pipe Nipple –** 1/2" NPT 316 Stainless Steel616Y28-SS
 1/2" BSPT 316 Stainless SteelAC-4SS

Pressure & Temperature Ratings –

- Manual Twist Drain (D) 0 to 20.7 bar
 -18°C to 82°C
- Manual Twist Drain (W) 0 to 17.2 bar
 -18°C to 66°C
- Automatic Float Drain 0 to 12 bar
 0°C to 66°C

Note: Air must be dry enough to avoid ice formation at temperatures below 2°C.

Weight 850 g

Specifications

- Bowl Capacity** 118 cm³
- Filter Rating** 40 Micron
- Sump Capacity** 50 cm³
- Port Threads** 1/2 Inch

Materials of Construction

- Body** 316 Stainless Steel
- Bowls** 316 Stainless Steel
- Deflector** Acetal
- Drain** 316 Stainless Steel
- Element Holder** Acetal
- Filter Element** Polyethylene
- Seals** Fluorocarbon
- Sight Gauge** Isoplast

PF11 Coalescing Filter – Standard



Features

- Stainless steel construction handles most corrosive environments
- Meets NACE specifications MR-01-75/ISO 15156
- High flow: 1/2" - 21 dm³/s[§]
- 1/8" female threaded drain
- High efficiency 0.01µm filtration
- Removes liquid aerosols and sub micron particles

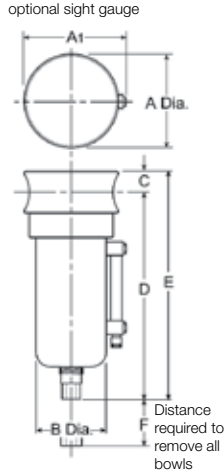

Port Size	BSPP		NPT	
	Manual Twist Drain	Automatic Float Drain	Manual Twist Drain	Automatic Float Drain
1/2"	Metal Bowl Without Sight Gauge			
	PF11G04DJSS	PF11G04DJRSS	PF11-04DJSS	PF11-04DJRSS

F11 Coalescing Filter Dimensions (mm)		
A 60	A1 64	B 44
C 14	D 127	E 141
F 54		

Standard part numbers shown bold.
For other models refer to ordering information below.

[§] dm³/s = Flow at 6.2 bar and a 0.3 bar pressure drop.

(mm)

Ordering Information

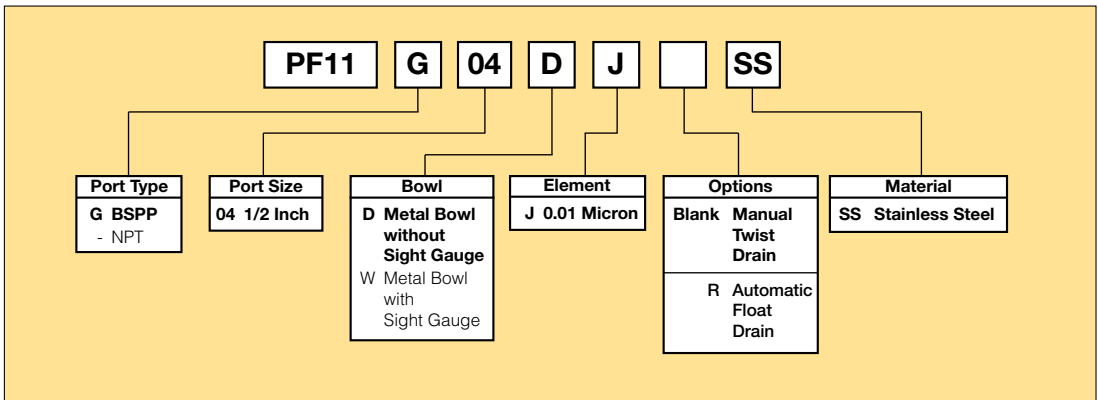

BOLD ITEMS ARE MOST POPULAR.

Technical Specifications – PF11

Operation

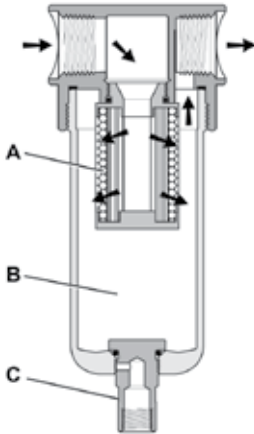

The contaminated air enters the element interior and is forced through a thick membrane (A) of “borosilicate” glass fibers coated with epoxy. Flow then passes through the element, and at this stage 99.97% of the sub micronic particles have been removed from the air stream. The tiny droplets coalesce together and are collected from the filter element by the outer drain layer. The clean, filtered air now passes through and out into the pneumatic system. The air line coalescing filter removes liquid aerosols and sub-micron particulate matter. Collected liquids and particles in the “quiet zone” (B) should be drained before their level reaches a height where they would be reentrained in the flowing air. This can be accomplished by unscrewing the drain valve (C) slightly until the liquid begins to drain.

Technical Information

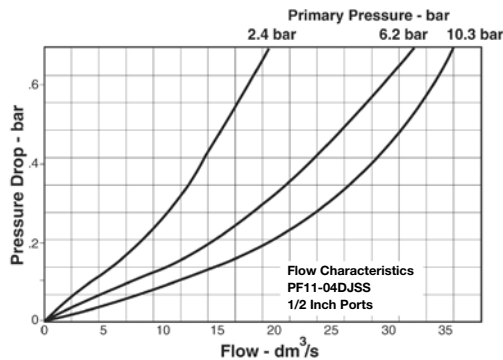

F11 Filter Kits & Accessories

Drain Kit –

- Automatic Float Drain SA10MDSS
- Manual Twist Drain–

 - Small (Old) SA600Y7-1SS
 - Large (New) SAP05481

Filter Element Kits –

- 0.01 Micron EKF71

Pipe Nipple –

- 1/2" NPT 316 Stainless Steel..... 616Y28-SS
- 1/2" BSPT 316 Stainless Steel..... AC-4SS

Pressure & Temperature Ratings –

- Manual Twist Drain 0 to 20.7 bar
-18°C to 82°C
- Manual Twist Drain (W) 0 to 17.2 bar
-18°C to 66°C
- Automatic Float Drain 0 to 12 bar
0°C to 66°C

Note: Air must be dry enough to avoid ice formation at temperatures below 2°C.

Weight 850 g

Materials of Construction

- Body** 316 Stainless Steel
- Bowls** 316 Stainless Steel
- Drain** 316 Stainless Steel
- Element Holder** Acetal
- Filter Element** Borosilicate Fiber
- Seals** Fluorocarbon
- Sight Gauge** Isoplast

Specifications

- Bowl Capacity** 118 cm³
- Filter Rating** 0.01 Micron
- Sump Capacity** 50 cm³
- Port Threads** 1/2 Inch

PR10, PR11 Regulator – Standard

Features

- Stainless steel construction handles most corrosive environments
- Large diaphragm to valve area ratio for precise regulation and high flow capacity
- Meets NACE specifications MR-01-75/ISO 15156
- Low temperature version available
- High flow: 1/2" – 37.75 dm³/s[§]

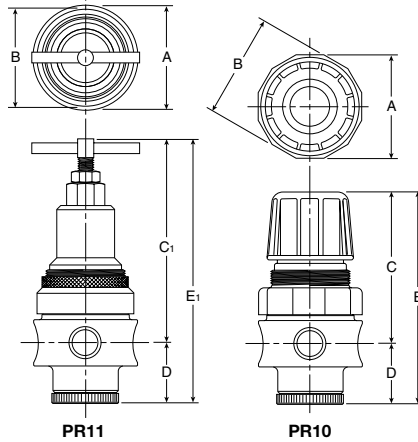

Port Size	BSPP	NPT
1/2"	PR10G04CSS	PR10-04CSS
1/2"	PR11G04CSS	PR11-04CSS

PR10, PR11 Regulator Dimensions (mm)		
A	B	C
60	62	91
C ₁	D	E
119	35	126
E ₁		
154		

Standard part numbers shown bold.

For other models refer to ordering information below.

[§] dm³/s = 7 bar inlet pressure with 5.5 bar set pressure and 1 bar pressure drop.

⚠ WARNING
<p>Product rupture can cause serious injury. Do not connect regulator to bottled gas. Do not exceed maximum primary pressure rating.</p>

(mm)
NOTE: 44mm dia. hole required for panel mounting.

Ordering Information

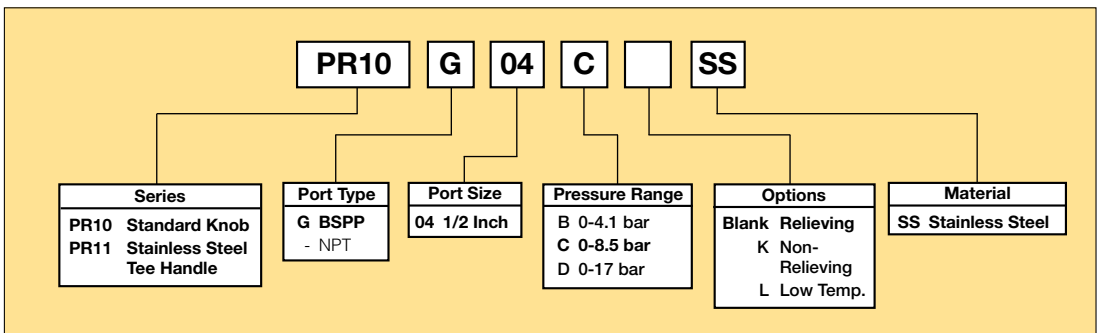

BOLD ITEMS ARE MOST POPULAR.

Technical Specifications – PR10, PR11

Operation

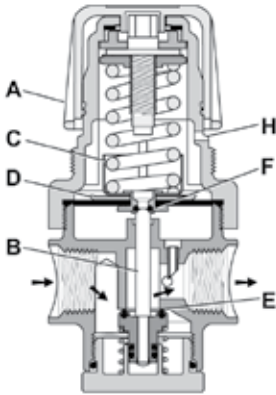

With the adjusting knob (A) turned fully counter-clockwise (no spring load), and pressure supplied to the regulator inlet port, the valve poppet assembly (B) is closed. Turning the adjusting knob clockwise applies a load to control spring (C). This load causes the diaphragm (D) and the valve poppet assembly (B) to move downward allowing flow across the seat area (E) created between the poppet assembly and the seat. Pressure in the downstream line is sensed below the diaphragm (D) and offsets the load of spring (C). As downstream pressure rises, poppet assembly (B) and diaphragm (D) move upward until the area (E) is closed and the load of the spring (C) and pressure under diaphragm (D) are in balance. A reduced outlet pressure has now been obtained, depending on spring load. Creating a demand downstream, such as opening a valve, results in a reduced pressure under the diaphragm (D). The load of control spring (C) now causes the poppet assembly to move downward opening seat area (E) allowing air to flow to meet the downstream demand. The flow of downstream air is metered by the amount of opening (E).

Should downstream pressure exceed the desired regulated pressure, the excess pressure will cause the diaphragm (D) to move upward against control spring (C), open vent hole (F), and vent the excess pressure to atmosphere through the hole in the bonnet (H). (This occurs in the relieving type regulator only)

Technical Information

CAUTION:

REGULATOR PRESSURE ADJUSTMENT –

The working range of knob adjustment is designed to permit outlet pressures within their full range. Pressure adjustment beyond this range is also possible because the knob is not a limiting device. This is a common characteristic of most industrial regulators, and limiting devices may be obtained only by special design.

For best performance, regulated pressure should always be set by increasing the pressure up to the desired setting.

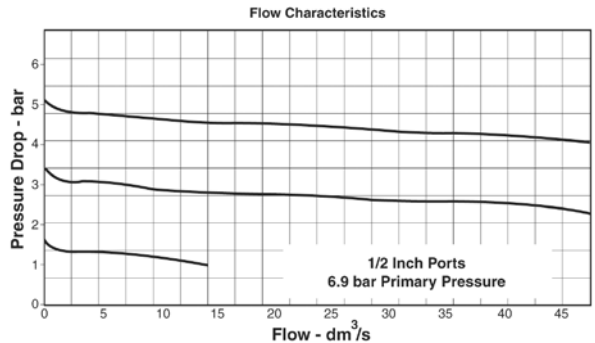

PR10, PR11 Regulator Kits & Accessories

R10 Bonnet Kit (Knob Included)	CKR10YSS
R11 Bonnet Kit	CKR11YSS
Gauge –	
0 - 10 bar	M1/4G40S-10
Panel Mount Bracket (Stainless)	R10Y57-SS
Panel Mount Nut –	
Stainless	R10X51SS
Plastic	R10X51-P
Pipe Nipple –	
1/2" NPT 316 Stainless Steel	616Y28-SS
1/2" BSPT 316 Stainless Steel	AC-4SS
Service Kit –	
Relieving	RKR10YSS
Non-Relieving	RKR10KYSS

Materials of Construction

Adjustment Mechanism / Springs	316 Stainless Steel
Body	316 Stainless Steel
Bonnet / Tee Handle (PR11)	316 Stainless Steel
Bonnet / Knob (PR10)	Acetal
Bottom Plug	316 Stainless Steel
Poppet	316 Stainless Steel
Seals	Fluorocarbon

Specifications

Gauge Port	1/4 Inch
Operation	Fluorocarbon Diaphragm
Port Threads	1/2 Inch
Pressure & Temperature Ratings –	
PR10	20.7 bar max. -18°C to 66°C
PR11	20.7 bar max. -18°C to 82°C
Option "L" minimum operating temperature*	-40° C/F

Note: Air must be dry enough to avoid ice formation at temperatures below 2°C.

Weight

* Note: "Low Temperature" option is intended for applications where the ambient temperature may be down to -40° C/F. Air supply must be free of moisture to prevent ice formation and malfunction of units. These units contain EPDM seals. Make sure any oils in the airstream are compatible.



PB11, PB12 Filter / Regulator – Standard

Features

- Stainless steel construction handles most corrosive environments
- Large diaphragm to valve area ratio for precise regulation and high flow capacity
- Meets NACE specifications MR-01-75/ISO-15156
- Low temperature version available
- High flow: 1/2" – 34 dm³/s[§]
- 1/8" female threaded drain

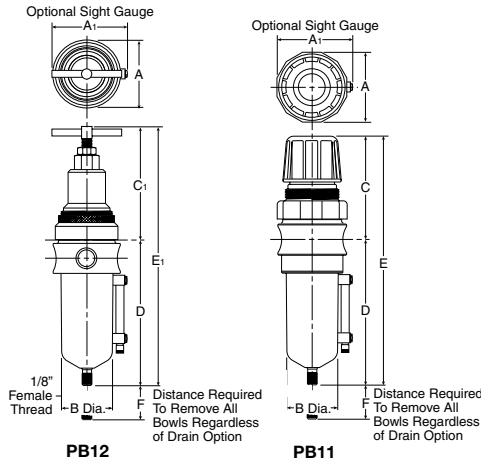
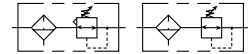

Port Size	Adjustment Type	BSPP		NPT	
		Manual Twist Drain	Automatic Float Drain	Manual Twist Drain	Automatic Float Drain
1/2"	Metal Bowl without Sight Gauge				
	Knob	PB11G04DJCSS	PB11G04DJCRSS	PB11-04DJCSS	PB11-04DJCRSS
	Tee-Handle	PB12G04DJCSS	PB12G04DJCRSS	PB12-04DJCSS	PB12-04DJCRSS

PB11, PB12 Piggyback Dimensions (mm)		
A	A1	B
60	64	44
C	C1	D
91	55	127
E	E1	F
218	246	54

Standard part numbers shown bold. For other models refer to ordering information below.

[§] dm³/s = 7 bar inlet pressure with 5.5 bar set pressure and 1 bar pressure drop.

(mm)
NOTE: 44mm dia. hole required for panel mounting.

⚠ WARNING

**Product rupture can cause serious injury.
Do not connect regulator to bottled gas.
Do not exceed maximum primary pressure rating.**

Ordering Information

PB11 G 04 D J C SS

Series	Port Type	Bowl	Element	Reduced Pressure Range	Options	Material
PB11 Standard Knob PB12 Stainless Steel	G BSPP - NPT	D Metal Bowl without Sight Gauge W Metal Bowl with Sight Gauge	J 40 Micron G 5 Micron	B 0-4.1 bar C 0-8.5 bar D 0-17 bar	Blank Relieving K Non-Relieving R Automatic Float Drain L Low Temp. *	SS Stainless Steel
	Port Size 04 1/2 Inch					

* Manual drain without sight gauge only

BOLD ITEMS ARE MOST POPULAR.

Technical Specifications – PB11, PB12

Operation

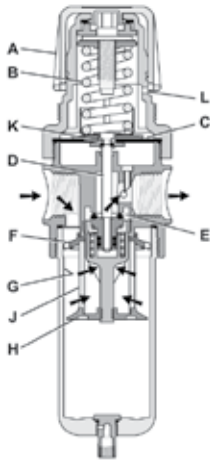

Turning the adjusting knob clockwise applies a load to control spring (B) which forces diaphragm (C) and valve poppet assembly (D) to move downward allowing filtered air to flow through the seat area (E) created between the poppet assembly and the seat. "First stage filtration". Air pressure supplied to the inlet port is directed through deflector plate (F) causing a swirling centrifugal action forcing liquids and coarse particles to the inner bowl wall (G) and down below the lower baffle (H) to the quiet zone. After liquids and large particles are removed in the first stage of filtration "second stage filtration" occurs as air flows through element (J) where smaller particles are filtered out and retained. The air flow now passes through seat area (E) to the outlet port of the unit. Pressure in the downstream line is sensed below the diaphragm (C) and offsets the load of spring (B). When downstream pressure reaches the set-point, poppet valve assembly (D) and diaphragm (C) move upward closing seat area (E). Should downstream pressure exceed the desired regulated pressure, the excess pressure will cause the diaphragm (C) to move upward opening vent hole (K) venting the excess pressure to atmosphere through the hole in the bonnet (L). (This occurs in the standard relieving type filter/regulators only.)

Technical Information

CAUTION:

REGULATOR PRESSURE ADJUSTMENT – The working range of knob adjustment is designed to permit outlet pressures within their full range. Pressure adjustment beyond this range is also possible because the knob is not a limiting device. This is a common characteristic of most industrial regulators, and limiting devices may be obtained only by special design.

For best performance, regulated pressure should always be set by increasing the pressure up to the desired setting.

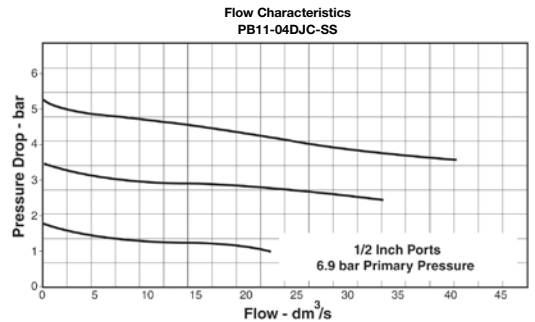

PB11, PB12 Regulator Kits & Accessories

Drain Kits -	
Automatic Float Drain.....	SA10MDSS
Manual Twist Drain -	
Small (Old).....	SA600Y7-1SS
Large (New).....	SAP05481
Filter Element Kits –	
Particulate (40 Micron).....	EKF10Y
Particulate (5 Micron).....	EKF10VY
Gauge –	
0 - 10 bar.....	M1/4G40S-10
Panel Mount Bracket (Stainless)	R10Y57-SS
Panel Mount Nut –	
Stainless.....	R10X51SS
Plastic.....	R10X51-P
Pipe Nipple –	
1/2" NPT 316 Stainless Steel.....	616Y28-SS
1/2" BSPT 316 Stainless Steel.....	AC-4SS
Service Kit –	
Relieving.....	RKR10YSS
Non-Relieving.....	RKR10KYSS

Materials of Construction

Adjustment Mechanism / Springs	316 Stainless Steel
Body	316 Stainless Steel
Bonnet / Knob (PB11)	Acetal
Bonnet / Tee Handle (PB12)	316 Stainless Steel
Bottom Plug	316 Stainless Steel
Poppet	316 Stainless Steel
Seals	Fluorocarbon
Sight Gauge	Isoplast

Specifications

Bowl Capacity	118 cm ³
Filter Rating	40 Micron
Gauge Port	1/4 Inch
Operation	Fluorocarbon Diaphragm
Port Threads	1/2 Inch
Pressure & Temperature Ratings –	
PB11 (Metal bowl D or W).....	20.7 bar -18°C to 66°C
PB12 (Metal bowl D).....	20.7 bar -18°C to 82°C
PB12 (Metal bowl W).....	20.7 bar -18°C to 66°C
Automatic float drain.....	1 to 12 bar 0°C to 66°C
Option "L" minimum operating temperature*	-40° C/F
Note: Air must be dry enough to avoid ice formation at temperatures below 2°C.	
Sump Capacity	50 cm ³
Weight	1090 g

* Note: "Low Temperature" option is intended for applications where the ambient temperature may be down to -40° C/F. Air supply must be free of moisture to prevent ice formation and malfunction of units. These units contain EPDM seals. Make sure any oils in the airstream are compatible.



PL10 Lubricator – Standard

Features

- Stainless steel construction handles most corrosive environments
- Fillable under pressure
- Meets NACE specifications MR-01-75/ISO 15156
- High flow: 1/2" - 47 dm³/s[§]
- 1/8" female threaded drain

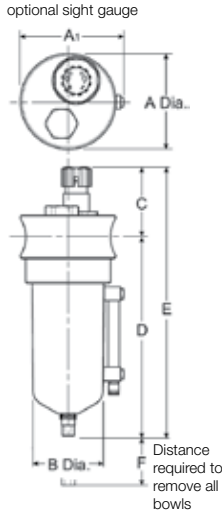

Port Size	BSPP	NPT
	Manual Twist Drain	Manual Twist Drain
1/2"	Metal Bowl Without Sight Gauge	
	PL10G04DSS	PL10-04DSS

PL10 Lubricator Dimensions (mm)		
A	A1	B
60	64	44
C	D	E
46	127	173
F		
89		

Standard part numbers shown bold.
For other models refer to ordering information below.

[§] dm³/s = Flow at 6.2 bar and a 0.3 bar pressure drop.

Ordering Information

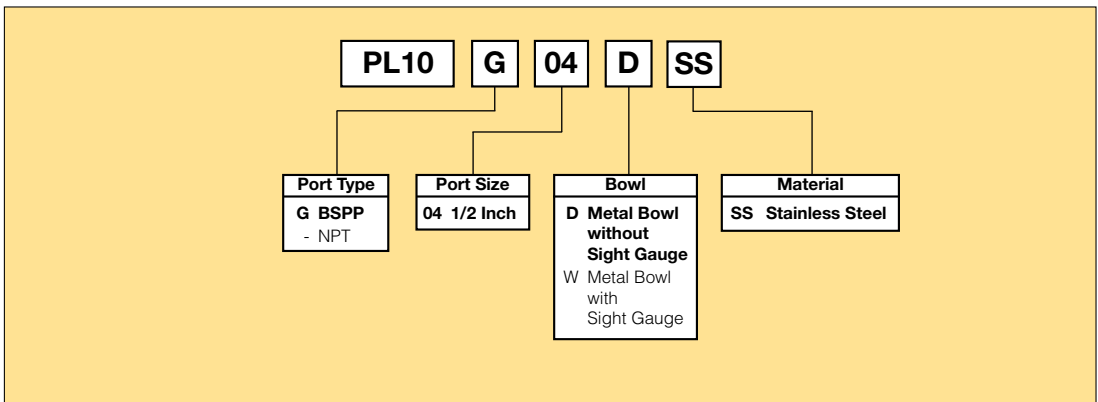

BOLD ITEMS ARE MOST POPULAR.

Technical Specifications – PL10

Operation

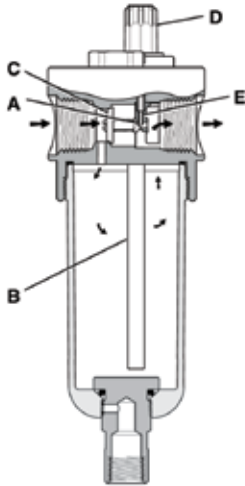

Air flowing through the unit goes through two paths. At low flow rates the majority of the air flows through the Venturi section (A). The rest of the air opens the check valve (C). The velocity of the air flowing through the Venturi section (A) creates a pressure drop. This lower pressure allows the oil to be forced from the reservoir through the pickup tube (B) and travels up to the metering screw (D). The rate of oil delivery is then controlled by adjusting the metering screw (D). Oil flows past the metering screw (D) and forms a drop in the nozzle tube (E). As the oil drops through the dome (F) and back into the Venturi section (A), it is broken up into fine particles. It is then mixed with the air flowing past the check valve (C) and is carried downstream. As the air flow increases the check valve (C) will open more fully. This additional flow will assure that the oil delivery rate will increase linearly with the increase of air flow.

Technical Information

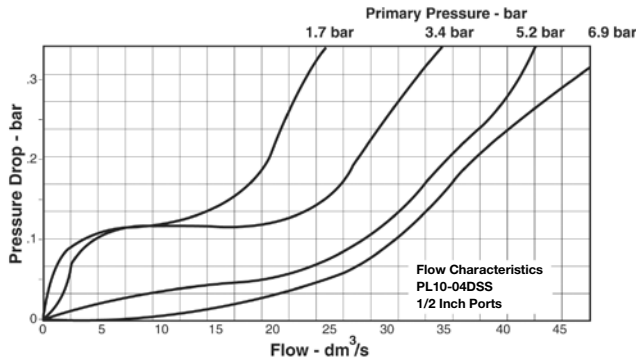

L10 Filter Kits & Accessories

Drain Kits -	
Manual Twist Drain -	
Small (Old).....	SA600Y7-1SS
Large (New).....	SAP05481
Pipe Nipple –	
1/2" NPT 316 Stainless Steel.....	616Y28-SS
1/2" BSPT 316 Stainless Steel.....	AC-4SS
Sight Dome Kit	RKL10SS

Specifications

Bowl Capacity	118 cm ³
Port Threads	1/2 Inch
Pressure & Temperature Ratings –	
Metal Bowl (D)	20.7 bar max. -18°C to 66°C
Metal Bowl (W)	0 to 17.2 bar -18°C to 66°C

Note: Air must be dry enough to avoid ice formation at temperatures below 2°C.

Weight

Materials of Construction

Body	316 Stainless Steel
Bowl	316 Stainless Steel
Dip Tube	316 Stainless Steel
Drain	316 Stainless Steel
Fill Plug	316 Stainless Steel
Seals	Fluorocarbon
Sight Dome	Nylon
Sight Gauge	Isoplast



Modular Hi Flow FRLs

P3N 1 Inch Series

The System

The Modular system allows units to be connected together, without the use of pipe connectors, saving space; providing constant mounting centres; whilst maintaining a modern aesthetically pleasing appearance.

The 1" Series filters are specially designed to efficiently filter out rust, dirt, moisture and other impurities from compressed air lines. Operation is fully automatic with a minimum of pressure drop.

The 1" Series Regulators are designed to provide quick response and accurate pressure regulation for the most demanding Hi-flow industrial applications. The unique solid piston was designed for long trouble-free operation and will not rupture or tear under high cycle or other demanding applications.

The 1" Series mist lubricators are designed to provide lubrication for many general purpose applications in a pneumatic system.

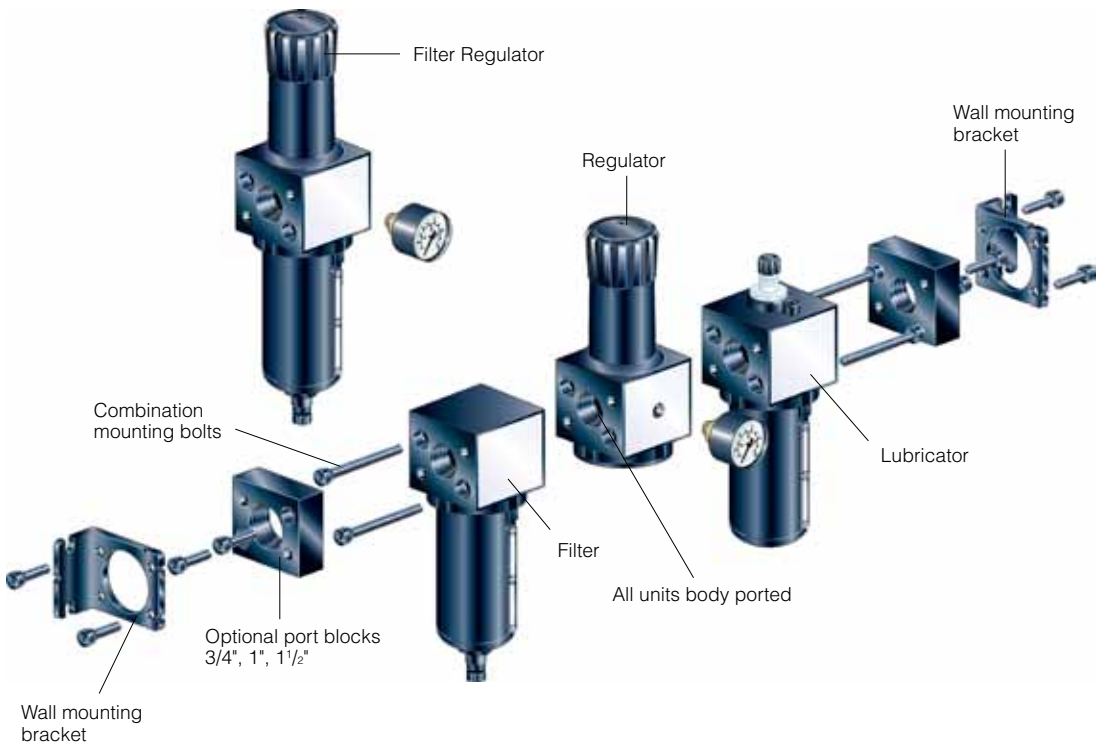

Combinations

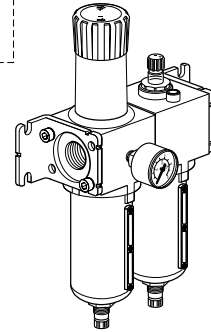
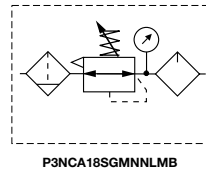
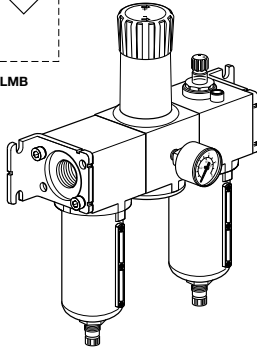
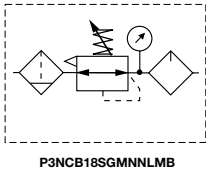

Typical Combination

1" FRL
 40 micron elements, 8 bar regulator
 + wall mounting brackets

Typical Combination

Filter/Regulator - Lubricator
 40 micron elements, 8 bar regulator
 + wall mounting brackets

P3N	C		1		S				L		B
Modular Combinations				Metal bowl with sight glass						Wall mounting brackets	
Units		Port type		Port size		Filter elements		Regulator type		Lubricator drain options	
Filter/reg + Lubricator	A	'G' Thread (BSPP)	1	1" ports	8	40 micron element (Standard)	G	Relieving	B	Metal bowl Manual drain	M
Filter+Regulator + Lubricator	B	NPT	9	1.1/2" ports (1" units with 1.1/2" port extensions)	P	5 micron element (Optional)	E	Non-relieving	N	Metal bowl No drain	N
				3/4" ports	6						
						Filter drain options		Reg. Pressure range			
						Manual Drain	M	Without gauge			
						Auto Drain	A	0 - 2 bar	Y		
								0 - 4 bar	L		
								0 - 8 bar	N		
								0 - 16 bar	H		
								With gauge			
								0 - 2 bar	Z		
								0 - 4 bar	M		
								0 - 8 bar	G		
								0 - 16 bar	J		

Filters

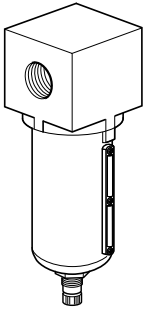

Symbols

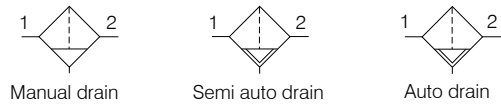

- Excellent water removal efficiency.
- Metal bowl with sight gauge.
- Larger filter element surface guarantees low pressure drop and increased element life.
- Manual drain or Auto Drain options.

Options:

P3N	F	A					
	Filter						
Port type		Port size		Filter elements		Bowl/drain options	
'G' Thread (BSPP)		1"		40 micron element (Standard)		Metal bowl Manual drain	
NPT		3/4"		5 micron element (Optional)		Metal bowl Auto drain	
	1		8		G		SM
	9		6		E		SA

Technical information

Port sizes	3/4" & 1"
Filter element grade:	Standard 40 micron Option 5 micron
Pressure range:	17 bar max
Temperature range:	-20°C to +80°C
Weight:	1600 g

Dimensions (mm)

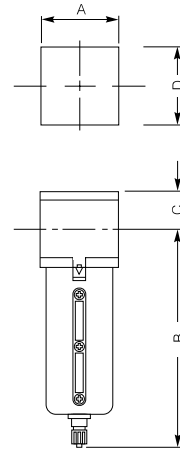

Port sizes	A	B	C	D
3/4" & 1"	92	254	35	92

Flow characteristics

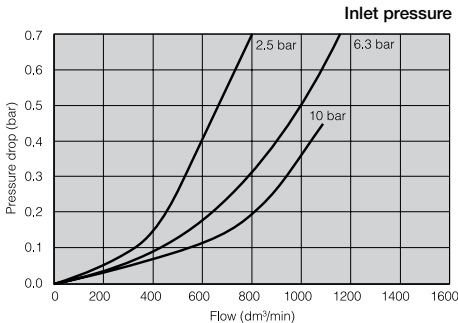

Filter Element Kits

5 Micron element	P3NKA00ESE
40 Micron element	P3NKA00ESG

Filter Spare Kits

Description	Order code
Manual drain kit	P3E-KA00DBN
Auto drain kit	P3E-KA00DDN

Coalescing and adsorber filters

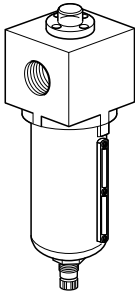

Note: To optimise the life of the coalescing element, it is advisable to install a P3NFA 5 micron pre-filter upstream of the coalescing filter. Always install a coalescing filter up-stream of the adsorber filter.

Symbols

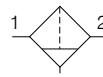

Manual drain

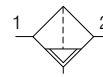

Semi auto drain

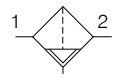

Auto drain

- DPI indicator as standard.
- Removes liquid aerosols and sub micron particles.
- Oil free air for critical applications.
- Metal bowl with sight gauge.
- Larger filter element surface guarantees low pressure drop and increased element life.
- Manual drain as standard or optional auto drain available (only on coalescing filter).
- Adsorbing activated carbon element removes oil vapour and most hydrocarbons.

Options:

P3N	F	A				
Coalescing Filter		Port type	Port size	Filter elements	Bowl/drain options	
		'G' Thread (BSPP)	1" ports	Coalescing 0.01µm with pressure drop indicator (Standard)	D	Metal bowl Manual drain
		NPT	3/4" ports	Adsorber element with pressure drop indicator	B	Metal bowl * Auto drain
				Adsorber element without pressure drop indicator	A	

* Coalescing filter only.

Technical information

Port sizes	3/4" & 1"
Coalescing element grade:	0.01 microns
Pressure range:	17 bar max
Temperature range:	-20°C to +80°C
Weight:	1600 g

Flow characteristics

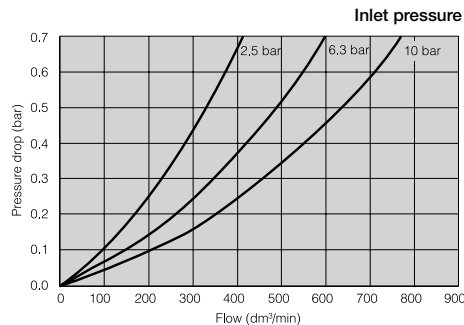

Dimensions (mm)

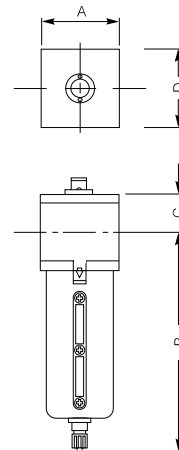

Port sizes	A	B	C	D
3/4" & 1"	92	254	35	92

Filter Element Kits

Coalescing element	P3NKA00ESC
Adsorber element	P3NKA00ESA

Regulators

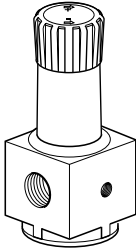

Symbols

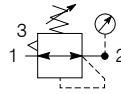

Self bleed regulator with gauge

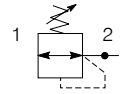

Non bleed regulator

- Self relieving feature plus balanced poppet provides quick response and accurate pressure regulation.
- Solid control piston for extended life.

Options:

P3N	R	A	1			N	
Regulator		Port type		Port size		Regulator type	
		'G' Thread (BSPP)	1	1" ports		Relieving	B
		NPT	9	3/4" ports		Non-relieving	N
				Regulator Pressure range			
				Without gauge	With gauge		
				0 - 2 bar	Y	0 - 2 bar	Z
				0 - 4 bar	L	0 - 4 bar	M
				0 - 8 bar	N	0 - 8 bar	G
				0 - 16 bar	H	0 - 16 bar	J

Technical information

Port sizes	3/4" & 1"
Gauge ports:	1/4"
Max inlet pressure (p1):	17 bar max
Secondary pressure range: (p2)	Standard: 0.1 to 8 bar Option 1: 0.1 to 2 bar Option 2: 0.1 to 4 bar Option 3: 0.3 to 16 bar
Temperature range:	-20°C to +80°C
Weight:	1900 g

Dimensions (mm)

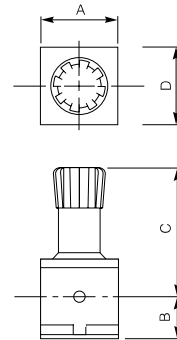

Port sizes	A	B	C	D
3/4" & 1"	92	53	162	92

Flow characteristics

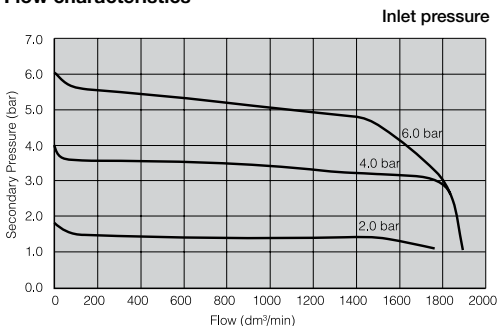

Regulator Spare Kits

Repair kit (self-relieving)	P3NKA00RR
Repair kit (non-relieving)	P3NKA00RN

Gauges

Description	Pressure range (bar)	Port size	Dial mm	Weight g	Order code
Rear entry	0-4	G1/4	50	74	P6G-ERB2040
Rear entry	0-14	G1/4	50	74	P6G-ERB2140
Rear entry	0-20	G1/4	50	74	P6G-ERB2200

Filter/Regulators

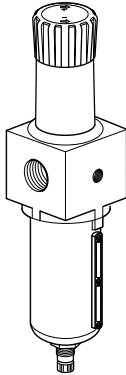

Symbol

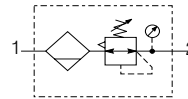

- Self relieving feature plus balanced poppet provides quick response and accurate pressure regulation.
- Solid control piston for extended life.

Options:

P3N	E	A	1					B	N	
Filter/ Regulator								Relieving		
Port type	Port size									
'G' Thread (BSPP)	1" ports 8									
NPT	3/4" ports 6									
	Filter elements		Bowl/drain options		Spring rating					
	40 micron element (Standard)		Metal bowl Manual drain		Without gauge		With gauge			
	5 micron element (Optional)		Metal bowl Auto drain		0 - 2 bar	Y	0 - 2 bar	Z		
	G		SM		0 - 4 bar	L	0 - 4 bar	M		
	E		SA		0 - 8 bar	N	0 - 8 bar	G		
					0 - 16 bar	H	0 - 16 bar	J		

Technical information

Port sizes	3/4" & 1"
Gauge ports:	1/4"
Max inlet pressure (p1):	17 bar max
Secondary pressure range: (p2)	Standard: 0.1 to 8 bar Option 1: 0.1 to 2 bar Option 2: 0.1 to 4 bar Option 3: 0.3 to 16 bar
Temperature range:	-20°C to +80°C
Weight:	2400 g

Dimensions (mm)

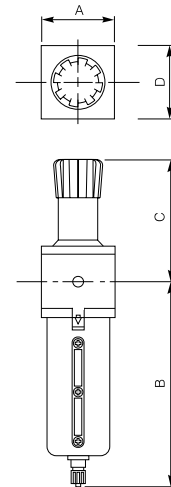

Port sizes	A	B	C	D
3/4" & 1"	92	243	162	92

Flow characteristics

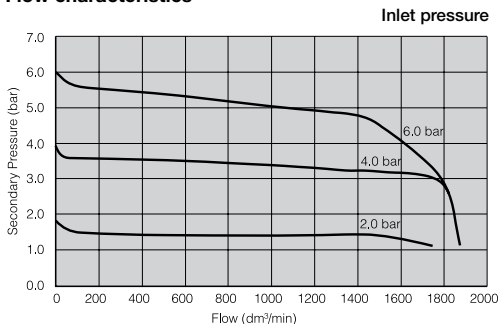

Filter/Regulator Spare Kits

5 Micron element	P3NKA00ESE
40 Micron element	P3NKA00ESG
Repair kit (self-relieving)	P3NKA00RR
Repair kit (non-relieving)	P3NKA00RN

Lubricators

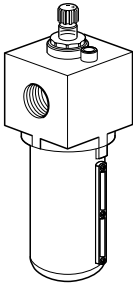

Symbols

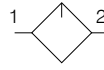

Lubricator

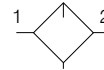

Lubricator with drain

- Proportional oil delivery over a wide range of air flows.
- Bowl can be filled while air line is under pressure.
- Transparent sight dome for 360° visibility.

Options:

P3N	L	A			L		
	Lubricator		Port type	Port size		Bowl/drain options	
			'G' Thread (BSPP)	1"	1" ports	8	Metal bowl Manual drain SM
			NPT	9	3/4" ports	6	Metal bowl No drain SN

Technical information

Port sizes	3/4" & 1"
Max inlet pressure (p1):	17 bar max
Min flow oil pickup:	3.7 dm ³ /s
Bowl capacity:	300cc
Recommended lubricant:	See page 190
Temperature range:	-20°C to +80°C
Weight:	1600 g

Dimensions (mm)

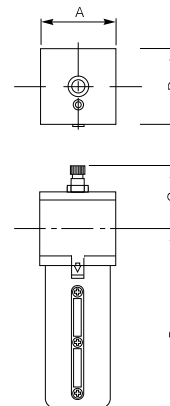

Flow characteristics

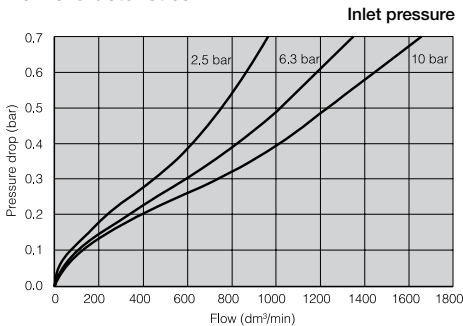

Port sizes	A	B	C	D
3/4" & 1"	92	230	71.3	92

Air pilot regulators

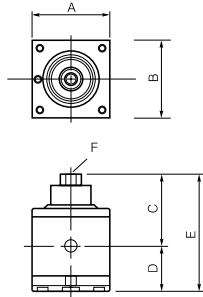
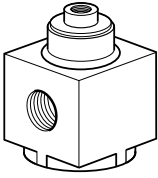

- Self relieving feature plus balanced poppet provides quick response and accurate pressure regulation.
- Solid control piston for extended life.

Order code

P3NRA18BPP

Dimensions (mm)

A	A (PB)	B	C	D	E	F
92	142	92	86	53	139	G ¹ / ₄

(PB = Port blocks)

Port Block Kits

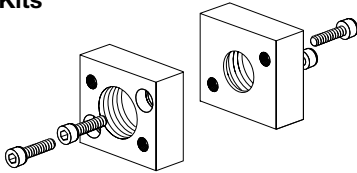

Description	Connection	Weight g	Order Code
Kits for single Units or Combinations without Lubricators (2 port blocks + 2 seals)	G ³ / ₄	574	P3NKB16CP
	G1	554	P3NKB18CP
	G ¹ / ₂	534	P3NKB1BCP
Kits for Combinations with Lubricators (2 port blocks + 2 seals)	G ³ / ₄	574	P3NKB16CL
	G1	554	P3NKB18CL
	G ¹ / ₂	534	P3NKB1BCL

For NPT threads change **1** to **9**.

Mounting brackets

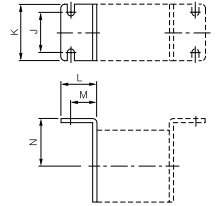
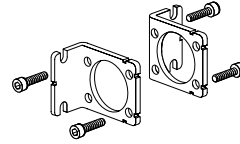

Order code

P3NKA00MW For 3/4 & 1" sizes

P3NKB00MW For 1.1/2" port size

Dimensions (mm)

L	M	N	J	K
45	33	60	50	70

Body Covers



Order code

P3NKA00PM

Each kit contains two covers.

Materials

Filter

Body	Aluminium
Bowl	Aluminium
Deflector	Plastic
Drain	Plastic
Seals	Nitril
Element	Plastic
Sight Glass	Polyamide

Lubricator

Body	Aluminium
Bowl (metal)	Aluminium
Drains	Plastic
Injector meter block & brass assembly	Plastic
Seals	Nitrile
Sight glass	Polyamide
Sight dome	Polycarbonate

Regulator

Adjustment Stem	Steel
Body	Aluminium
Bonnet	Aluminium
Knob	Plastic
Piston	Plastic
Poppet Assembly	Brass
Seals	Nitrile
Spring (Poppet & Control)	Steel

Filter/Regulator

Body, Bonnet & Bowl	Aluminium
Deflector	Plastic
Drains	Plastic
Seals	Nitrile
Element	Plastic
Sight glass	Polyamide
Piston	Plastic
Knob	Plastic
Spring (Poppet & Control)	Steel

Lubrication of airlines

Satisfactory operation of airline equipment and effective lubrication depends upon the proper selection of lubrication oil. Oils having a viscosity below ISO3448 Grade 10 to 22 will satisfy most high-speed pneumatic tools and other light duty requirements.

Heavy duty tools and pneumatic valves and cylinders will normally require oils in the viscosity ISO3448 Grade 32 to 68.

Only Paraffinic based oils can be used and the following recommendations are given as a general guide to types of oil that are suitable for use with Parker airline equipment.

Oil Company	High speed tools and systems		Air Cylinders and valves	
	ISO Grade	Grade	ISO Grade	Grade
Century Oils	Century P - 198	15	P.W.L.A	32
Alexander Duckham	Zurcon 2	15	Zurcon 4 32	
Gulf	Harmony 38AW	15	Harmony 43AW	32
Shell (UK) Oil	Tellus 22	22	Tellus 37	37
Burmah Castrol	Hyspin AWS15	15	Hyspin AWS32	32
Edgar Vaughan	KSO 5L	10	Hydrodrive HP100	32
Esso Petroleum	NUTO 1115	15	NUTO H32	32
B.P.	HLP 22	22	HLP 32	32
Mobile Oil Company	Velocite No.6	10	DTE Oil - Light	32
Mobile			VPI-A	32
Silkolene	Silkair GP22	22	Derwent 32	32
Silkolene	Dove 15	15		
Shell	Cassida Fluid HF*	32		
Klüberoil	4UH1*	32		

* For food industry applications : approved oil USDA-H1

Most Parker Pneumatic valves and cylinders are designed for use in non-lube operation. However airline lubrication will increase the service life.

Note! If oil lubrication is used, it must be maintained for the service life of the product.

Some specialised lubricants, particular synthetic reclaimed oils and low temperature additives, may contain compounds which are incompatible with certain materials, internal 'O' rings and seals. They may also attack plastic piping or the transparent bowls of the airline lubricator. Attention is drawn to BS6005 (Specification for moulded transparent polycarbonate bowls used in compressed air filters and lubricators).

Do not use oils with additives, compounds oils containing solvents, graphite, detergents or synthetic oils.



High Precision Regulators

R210 / R220 / R230 Series

R210 / 220 High Precision Regulator

Features

- Accurate Pressure Regulation. Controls Output Pressure to within 0.1% Accuracy.
- Multi-Stage Regulation for Maximum Control and Stability.
- Two Full Flow Gauge Ports.
- Super Sensitive Relief. Downstream Pressure Buildup, Down to 0.3m bar Above the Set Pressure, is Automatically Vented through Internal Relief Valve.
- R220 has High Exhaust Relief Capacity.



Applications

The R210 and R220 regulators are well suited for any process that requires very precise regulation of air pressure in pipes and vessels. These regulators are often used, but not limited to the following applications:

- Air Gauging
- Gas Mixing
- Calibration Standards
- Air Hoists
- Web Tensioning
- Gate Actuators
- Roll Loading
- Valve Operators
- Cylinder Loading

R210 / R220 Regulator Dimensions		
A 52mm	B 110mm	C 97mm
D 13.5mm		

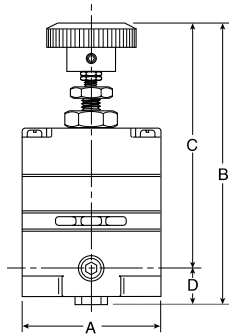

⚠ WARNING

Do not connect regulator to bottled gas.

Do not exceed maximum primary pressure rating.

Product rupture can cause serious injury.

The R210 / R220 are high precision, multi-stage pressure regulators. This pressure controller provides the highest level of regulation accuracy and repeatability available and is ideal for applications that call for the utmost in control and maximum stability under variable operating conditions. A stainless steel measuring capsule is used as a sensing element to activate the high gain servo balanced control mechanism in which the main valve is controlled by a pilot valve. This allows for greater accuracy and eliminates many of the problems associated with conventional regulators using range springs and diaphragms.

Ordering Information

		Reduced Pressure Range (Bar)		
Relieving		0.13 to 2.7	0.13 to 8.2	0.13 to 8.2 High Relief
In / Out Ports	1/4"	R210G02A	R210G02C	R220G02C

Technical Information

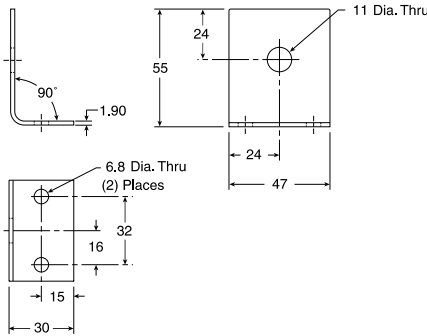
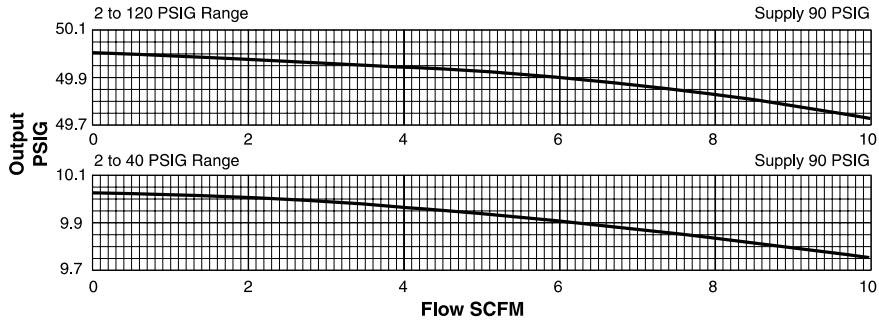

Mounting Bracket: 446-707-045

R210 / R220 Regulator Kits & Accessories

Mounting Bracket Kits

- Pipe MountingSA200YW57
- Right Angle Mounting..... 446-707-045

Service Kits

- 0.13 to 2.7 bar RKR210A
- 0.13 to 8.2 bar RKR210C
- 0.13 to 8.2 bar (High Relieving) RKR220C

Materials of Construction

- Adjusting Stem & CapsuleStainless Steel
- Body Zinc
- Control KnobPlastic
- Diaphragm(s) Buna-N
- Seals Buna-N
- SpringsStainless Steel
- Valve PoppetStainless Steel

Specifications

Constant Bleed Rate	Less than 0.15m ³ /hr (Equals Bleed Rate plus other consumption)
Total Air Consumption	0.21m ³ /hr.
Effect of Supply Pressure Variation of 1.7 bar on outlet:	Less than 0.3m bar
Exhaust (Relief) Capacity At 0.34 bar above 1.38 bar Setpoint	
Standard Model	3.4m ³ /hr
High-Relief Model	17m ³ /hr
Flow Capacity	
At 9 bar Supply, 1.38 bar Outlet	25m ³ /hr
Gauge Ports	1/4"
(Can be used as additional full flow 1/4" outlet ports)	
Operating Pressure Range:	bar
PRIMARY – Maximum	10
SECONDARY – Spring Pressure	
2.7 bar Minimum	0.14
Maximum	2.70
8.2 bar Minimum	0.14
Maximum	8.2
Operating Temperature Range	-18°C * to 65°C
* Temperatures below 0°C require moisture free air.	
Repeatability / Sensitivity	0.3m bar Inches of Water Column = 1/8"
Weight640g

R230 High Flow Precision Regulator

Features

- Adjusting Knob.
- Diaphragm Design for Good Repeatability, Response and Sensitivity.
- Balanced Poppet.
- Two Full Flow Gauge Ports.
- Precise Regulation. Will Sense a Decrease in Downstream Pressure as Small as 1/4" of Water.
- High Flow Capacity. Flows of 37.8dm³/s Attainable with Minimal Drop.
- Stable Output. Dampening Action of Aspiration Tube makes Regulator Insensitive to Changes in Flow.
- On-line Maintenance. Can be Serviced Without Removal of Air Line.

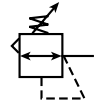

R230 Regulator Dimensions		
A 76mm	B 10mm	C 86mm
D 154mm	E 57mm	

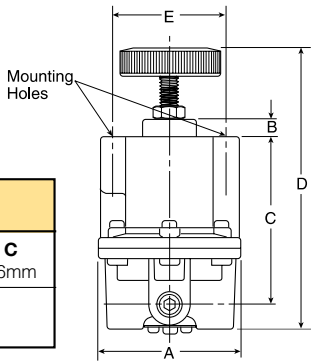

Applications

The R230 regulators are an ideal choice for any application that calls for accurately maintained output pressure under high flow conditions. This includes, but is not limited to such applications as:

- Test Equipment
- Gas Mixing
 - Valve Operators
 - Positioning Cylinders
 - Laboratory Equipment
 - Web Tensioning
 - Clutch & Brake Controls
 - Roll Loading
 - Test Panels
 - Actuators

⚠ WARNING

Do not connect regulator to bottled gas.

Do not exceed maximum primary pressure rating.

Product rupture can cause serious injury.

The R230 is designed for applications that require high flow capacity and accurate process control. A poppet valve which is balanced by utilizing a rolling diaphragm, insures a constant output pressure even during wide supply pressure variations. Stability of regulated pressure is maintained under varying flow conditions through the use of an aspirator tube which adjusts the air supply in accordance with the flow velocity.

Ordering Information

		Reduced Pressure Range (Bar)			
Relieving		0 to 0.13	0 to 2	0 to 4	0 to 10
In / Out Ports	1/4"	R230G02E	R230G02B	R230G02C	R230G02D

Technical Information

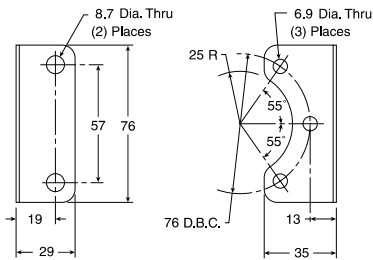
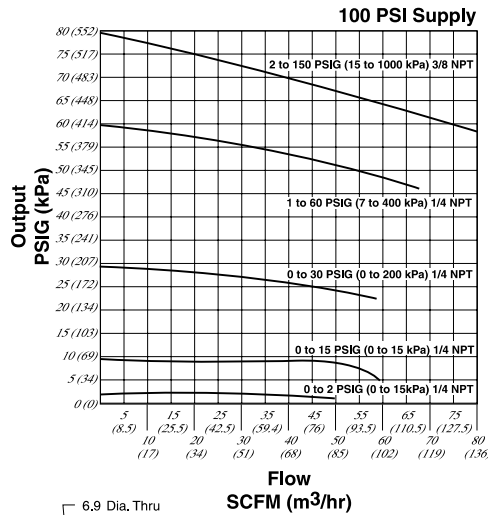

Mounting Bracket: 446-707-025

R230 Regulator Kits & Accessories

Mounting Bracket Kit 446-707-025

Service Kits – Relieving

- 0 to 0.13 bar RKR230E
- 0 to 2 bar RKR230B
- 0 to 4 bar RKR230C
- 0 to 10 bar RKR230D

Materials of Construction

- Adjusting Stem & Spring Steel
- Biased Spring Stainless Steel
- Body, Bonnet Aluminum
- Control Knob Plastic
- Diaphragm Buna-N Elastomer and Polyester Fabric
- Seals Buna-N
- Valve Poppet Brass
- Valve Poppet Seat Buna-N

Specifications

- Constant Bleed Rate upto 0.35m³/h
(Depending upon output pressure)
- Gauge Ports Two Ports 1/4"
(Can be used as additional Full Flow 1/4 Inch Outlet Ports)
- Effect of Supply Pressure Variation –
Less than 6mbar for 6.89 bar change
- Exhaust (Relief) Capacity –
1.88 dm³/s with downstream pressure 0.3 bar above set pressure.
Exhaust commences at 0.7m bar above set pressure.
- Flow Capacity –
At 6.89 bar Supply,
5.5 bar Outlet..... 37.8 dm³/s
- Operating Temperature Range – -40°C to 71°C
- Operating Pressure Range – bar
PRIMARY – Maximum 17
- Port Threads 1/4"
- Exhaust (Relief) Capacity 1.88 dm³/s
(Downstream pressure 0,3 bar above set pressure)
- Repeatability / Sensitivity 6m bar
Inches of Water Column = 1/4"
- Response 250 ms
The valve will open to full flow and fill a volume of 1250 cm³
- Weight 740g



Cylinder Control Accessories

- For direct mounting on to cylinder
- Allen key adjustment
- Push-in connection
- Wide range of sizes



Operating and additional information

Operating pressure: 1 to 10 bar
 Operating temperature: -25°C to +100°C
 Sealing device: M5 Nylon washer
 1/8 - 1/2 BSPP Nitrile E.D. seal
 Terminations: 4mm - 12mm push-in connection
 6mm - 12mm - compression connection
 Maximum connecting torque: M5= 0,5Nm ; 1/8=9Nm ; 1/4=15Nm ; 3/8=22Nm ; 1/2=42Nm
 Body material: Brass black epoxy coated
 Lock nut: Brass

PTFL4/8PB - Flow regulator with push-in connection

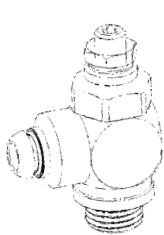

Thread	Push-in connection	Number of turns	Qmax input at 6 bar, l/min*	Weight g	Order code
M5x0,8	4	19	33,4	15	PTFL8PB4M5**
G1/8	4	18	105	42	PTFL4PB4-1/8
M5x0,8	6	19	36	19	PTFL8PB6M5**
G1/8	6	18	160	44	PTFL4PB6-1/8
G1/4	6	12,5	360	74	PTFL4PB6-1/4
G3/8	6	17	440	147	PTFL4PB6-3/8
G1/8	8	18	160	64	PTFL4PB8-1/8
G1/4	8	12,5	355	79	PTFL4PB8-1/4
G3/8	8	17	720	152	PTFL4PB8-3/8
G1/4	10	12,5	380	76	PTFL4PB10-1/4
G3/8	10	17	835	138	PTFL4PB10-3/8
G1/2	10	21	974	224	PTFL4PB10-1/2
G3/8	12	17	805	143	PTFL4PB12-3/8
G1/2	12	21	1284	225	PTFL4PB12-1/2

* Screw closed

** These fittings are supplied with Nylon seal

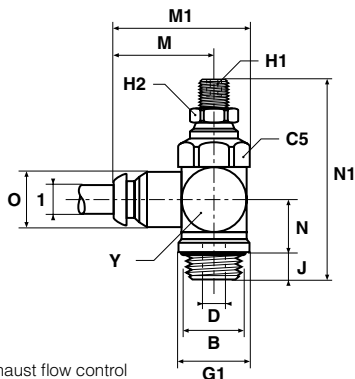

Exhaust flow control

Dimensions (mm)												
Order code	C5	D	G1	H1	H2	J	M	M1	N	N1	O	Y
PTFL8PB4M5**	8	1,65	10,0	1,5	8	4	19,5	24,5	6,3	28,5	10	10
PTFL4PB4-1/8	14	3,00	14,4	2,0	7	6	22,0	30,1	10,7	43,7	10	14
PTFL8PB6M5**	8	1,65	10,0	1,5	8	4	20,5	26,5	7,3	31,0	12	12
PTFL4PB6-1/8	14	3,20	14,4	2,0	7	6	23,5	31,6	10,7	43,7	12	14
PTFL4PB6-1/4	17	5,20	18,4	4,0	11	7	25,0	34,9	13,8	51,8	12	17
PTFL4PB6-3/8	22	5,50	21,6	4,0	11	7	28,0	40,7	17,3	63,7	12	22
PTFL4PB8-1/8	14	3,20	14,4	2,0	7	6	25,0	33,1	10,7	43,7	14	14
PTFL4PB8-1/4	17	5,20	18,4	4,0	11	7	28,5	38,3	13,8	51,8	14	17
PTFL4PB8-3/8	22	6,00	21,6	4,0	11	7	29,5	42,2	17,3	63,7	14	22
PTFL4PB10-1/4	17	5,20	18,4	4,0	11	7	31,5	41,3	13,8	51,8	17	17
PTFL4PB10-3/8	22	6,00	21,6	4,0	11	7	34,0	46,7	17,3	63,7	17	22
PTFL4PB10-1/2	27	8,00	26,5	4,0	14	9	36,5	52,1	20,1	76,1	17	27
PTFL4PB12-3/8	22	6,00	21,6	4,0	11	7	34,0	46,7	17,3	63,7	20	22
PTFL4PB12-1/2	27	8,50	26,5	4,0	14	9	36,5	52,1	20,1	76,1	20	27

- For direct mounting on to cylinder
- Allen key adjustment
- Push-in connection
- Wide range of sizes



Operating and additional information

Operating pressure: 1 to 10 bar
 Operating temperature: -25°C to +100°C
 Sealing device: M5 Nylon washer
 1/8 - 1/2 BSPP Nitrile E.D. seal
 Terminations: 4mm - 12mm push-in connection
 1/8 - 1/2 BSPP + M5 Female thread DIN 3852 long
 Maximum connecting torque: M5= 0,5Nm ; 1/8=9Nm ; 1/4=15Nm ; 3/8=22Nm ; 1/2=42Nm
 Body material: Brass blackepoxy coated
 Lock nut: Brass

PTF4/8PB - Flow regulator with push-in connection

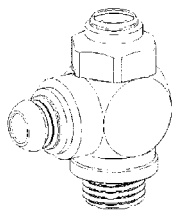

Symbol



Thread	Push-in connection	Number of turns	Qmax input at 6 bar, l/min*	Weight g	Order code
M5x0,8	4	19	33,4	14	PTF8PB4M5**
G1/8	4	18	105	35	PTF4PB4-1/8
M5x0,8	6	19	36	19	PTF8PB6M5**
G1/8	6	18	160	37	PTF4PB6-1/8
G1/4	6	12,5	360	65	PTF4PB6-1/4
G1/4	6	17	440	142	PTF4PB6-3/8
G1/8	8	18	160	43	PTF4PB8-1/8
G1/4	8	12,5	355	70	PTF4PB8-1/4
G3/8	8	17	720	146	PTF4PB8-3/8
G1/4	10	12,5	380	67	PTF4PB10-1/4
G3/8	10	17	835	131	PTF4PB10-3/8
G1/2	10	21	974	231	PTF4PB10-1/2
G3/8	12	17	805	200	PTF4PB12-3/8
G1/2	12	21	1284	232	PTF4PB12-1/2

* Screw closed

** These fittings are supplied with Nylon seal

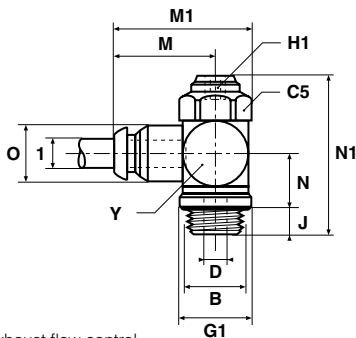

Exhaust flow control

Order code	Dimensions (mm)										
	C5	D	G1	H1	J	M	M1	N	N1	O	Y
PTF8PB4M5**	8	1,65	10,0	1,5	4	19,5	24,5	6,3	22,0	10	10
PTF4PB4-1/8	14	3,00	14,4	2,0	6	22,0	30,1	10,7	34,5	10	14
PTF8PB6M5**	8	1,65	10,0	1,5	4	20,5	26,5	7,3	24,5	12	12
PTF4PB6-1/8	14	3,20	14,4	2,0	6	23,5	31,6	10,7	34,5	12	14
PTF4PB6-1/4	17	5,20	18,4	4,0	7	25,0	34,9	13,8	41,0	12	17
PTF4PB6-3/8	22	5,50	21,6	4,0	7	28,0	40,7	17,3	51,0	12	22
PTF4PB8-1/8	14	3,20	14,4	2,0	6	25,0	33,1	10,7	34,5	14	14
PTF4PB8-1/4	17	5,20	18,4	4,0	7	28,5	38,3	13,8	41,0	14	17
PTF4PB8-3/8	22	6,00	21,6	4,0	7	29,5	42,2	17,3	51,0	14	22
PTF4PB10-1/4	17	5,20	18,4	4,0	7	31,5	41,3	13,8	41,0	17	17
PTF4PB10-3/8	22	6,00	21,6	4,0	7	34,0	46,7	17,3	51,0	17	22
PTF4PB10-1/2	27	8,00	26,5	4,0	9	36,5	52,1	20,1	61,0	17	27
PTF4PB12-3/8	22	6,00	21,6	4,0	7	34,0	46,7	17,3	51,0	20	22
PTF4PB12-1/2	27	8,50	26,5	4,0	9	36,5	52,1	20,1	61,0	20	27

- For direct mounting on to cylinder
- Allen key adjustment
- Push-in connection
- Wide range of sizes



Operating and additional information

Operating pressure:	1 to 10 bar
Operating temperature:	-25°C to +70°C
Bolt material:	Brass black epoxy coated
Swivel elbow material:	High resistance polyamide
Bolt material:	Brass
Bolt threads:	M5 - 1/8 BSPP - 1/4 BSPP - 3/8 BSPP
Sealing device:	Nylon washer
	1/8 - 3/8 BSPP Nitrile E.D. seal
Terminations:	4mm - 8mm push-in connection
Maximum connecting torque:	M5= 0,5Nm ; 1/8=9Nm ; 1/4=15Nm ; 3/8=22Nm ; 1/2=42Nm
Adjustment screw:	Brass

Flow adjustment

Flow control is adjusted with an Allen key.
 The large number of turns from fully closed to fully open allows for precise flow control.

PTF4/8E6PB - Flow regulator with push-in connection

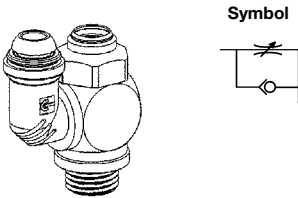

Thread	Push-in connection	Number of turns	Qmax input at 6 bar, l/min*	Weight g	Order code
M5x0,8	4	19	35	16	PTF8E6PB4M5**
G1/8	4	18	68	37	PTF4E6PB4-1/8
M5x0,8	6	18	37	20	PTF8E6PB6M5**
G1/8	6	18	175	38	PTF4E6PB6-1/8
G1/4	6	12,5	215	70	PTF4E6PB6-1/4
G3/8	6	17	250	132	PTF4E6PB6-3/8
G1/8	8	18	155	40	PTF4E6PB8-1/8
G1/4	8	12,5	343	73	PTF4E6PB8-1/4
G3/8	8	17	505	136	PTF4E6PB8-3/8

* Screw closed
 ** These fittings are supplied with Nylon seal

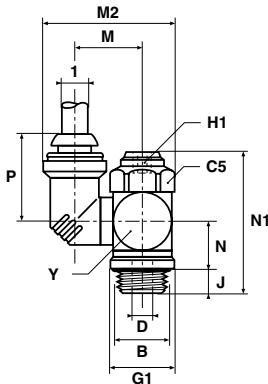

Order code	Dimensions (mm)										
	C5	D	G1	H1	J	M	M2	N	N1	P	Y
PTF8E6PB4M5**	8	1,65	10,0	1,5	4	11,7	18,4	6,2	22,5	20,5	10
PTF4E6PB4-1/8	14	3,00	14,4	2,0	6	14,3	30,0	10,7	34,5	20,5	14
PTF8E6PB6M5**	8	1,65	10,0	1,5	4	12,7	20,4	7,2	24,5	23,0	12
PTF4E6PB6-1/8	14	3,20	14,4	2,0	6	15,3	31,0	10,7	34,5	23,0	14
PTF4E6PB6-1/4	17	5,20	18,4	4,0	7	17,3	35,0	13,8	41,0	23,0	17
PTF4E6PB6-3/8	22	5,50	21,6	4,0	7	19,8	40,0	17,3	51,0	23,0	22
PTF4E6PB8-1/8	14	3,20	14,4	2,0	6	16,8	33,5	10,7	34,5	25,0	14
PTF4E6PB8-1/4	17	5,20	18,4	4,0	7	18,3	37,0	13,8	41,0	25,0	17
PTF4E6PB8-3/8	22	6,00	21,6	4,0	7	20,8	42,0	17,3	51,0	25,0	22

Exhaust flow control

- Micrometer type adjustment
- Fine control
- Non-return and needle valves



- Screw driver adjustment
- Rugged bodies
- High flow rate
- High flow by-pass
- Wide range of sizes



Operating and additional information

Micrometer flow control valves

Operating pressure: 0 to 17 bar
 Operating temperature: -40°C to +80°C
 Body material: Brass
 Control knob: Aluminium
 Adjustment mode: Knurled knob

Heavy duty Inline flow control valves

Operating pressure: 0 to 17 bar for air or oil
 Operating temperature: -18°C to +82°C
 Body material: Brass
 Control knob: Brass
 Adjustment mode: Screw driver adjustment

Flow Control with By-pass

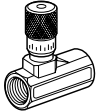

Symbol



Thread	Number of turns	Qmax input at 6 bar, l/min	Weight g	Order code
G1/8	5	300	76	337A
G1/4	6	780	134	337B

Flow Control with By-directional Control



Symbol



Thread	Number of turns	Qmax input at 6 bar, l/min	Weight g	Order code
G1/8	5	300	78	338A
G1/4	6	780	132	338B

Micrometer Flow Control Valves - Dimensions

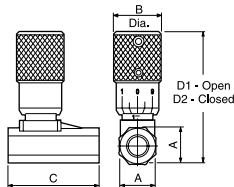

Order code	Port size	Dimensions (mm)				
		A	B	C	D1 open	D2 closed
337A	G1/8	14,5	19	37,5	51,5	46
337B	G1/4	17,5	19	37,5	58	51
338A	G1/8	14,5	19	37,5	51,5	46
338B	G1/4	17,5	19	37,5	58	51

Standard type

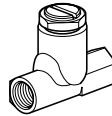

Symbol



Thread	Number of turns	Qmax input at 6 bar, l/min	Weight g	Order code
G1/8	6	1320	114	B3250X
G1/4	5	2880	224	B3250AB
G3/8	5	6300	378	B3250BB
G1/2	5	7680	792	B3250CB
G3/4	4,5	10680	1300	B3250DB

Flow Control Valves, Standard Type

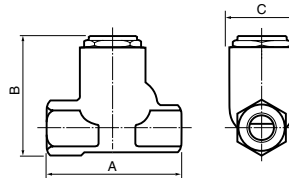

Order code	Port size	Dimensions (mm)		
		A	B	C
B3250X	G1/8	44	40	21
B3250AB	G1/4	57	51	28
B3250BB	G3/8	68	64	35
B3250CB	G1/2	79	78	41
B3250DB	G3/4	90	92	51

- Integral mounting holes
- Screw driver adjustable
- Panel mounting option



Operating and additional information

Working pressure Max 10 bar
 Working temperature -20 °C to +70 °C

Flow Control Valves with By-pass

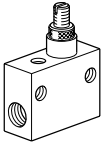

Symbol



Thread	Number of turns	Qmax input at 6 bar, l/min	Weight g	Order code
G1/8	13	72	30	VQB12-Q-0X-5*
G1/8	13	240	30	VQB12-Q-0-5
G1/4	13	1320	70	VQB22-Q-0-5
G1/2	13	3600	270	VQB42-Q-0-5

Flow Control Valves with By-directional Control

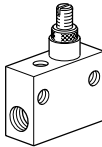

Symbol



Thread	Number of turns	Qmax input at 6 bar, l/min	Weight g	Order code
G1/8	13	72	30	VQB12-0X-5*
G1/8	13	240	30	VQB12-0-5
G1/4	13	1320	70	VQB22-0-5
G1/2	13	3600	260	VQB42-0-5

* Extra fine adjustment

Knob and nut for Panel Mounting

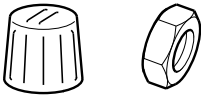

To Suit	Weight g	Order code
VQB12	8	9128177212
VQB22	14	9128177222
VQB42	37	9128177242

Flow Control Valves - Dimensions

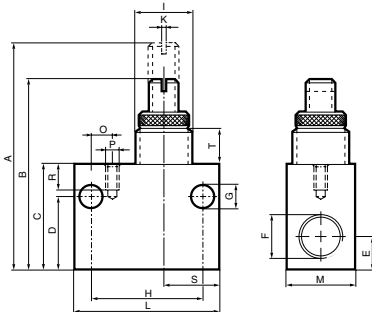

Order code	Dimensions (mm)								
	A	B	C	D	E	F	G	H	I
VQB12-(Q)-OX-549	42	22	15	6,5	G1/8	5,8	24	M12x1	
VQB12-(Q)-O-5	49	42	22	15	6,5	G1/8	5,8	24	M12x1
VQB22-(Q)-O-5	64	53	30	21	8,5	G1/4	7,0	32	M16x1
VQB42-(Q)-O-5	99	85	50	36	16,5	G1/2	7,0	50	M24x1,5

Order code	Dimensions (mm)							
	K	L	M	O	P	R	S	T
VQB12-(Q)-OX-51,2	32	15	-	-	-	-	13,5	8,8
VQB12-(Q)-O-5	1,2	32	15	-	-	-	13,5	8,8
VQB22-(Q)-O-5	1,2	42	20	6,0	M4	7	16,0	10,0
VQB42-(Q)-O-5	1,8	62	30	19,5	M4	7	20,5	15,2

- For inline or surface mounting
- Manual adjustment by knob with lock nut
- Instant push-in fitting
- High flow
- Wide range of sizes



Suitable for use:-

- Flow Regulators
- Blockers
- Unloaders
- Combined devices
- Optimisers
- Soft Start



Operating and additional information

Speed flow control valves - PWR-L

Operating pressure: 1 to 10 bar
 Permissible fluids: Air or neutral gas
 Operating temperature: -15°C to +70°C
 Storage temperature: -20°C to +70°C
 Vibration resistance: Conforming to section 19-2 of Bureau Veritas regulations
 Body material: Thermo plastic
 Adjustment: Knurled knob
 Adjustment locking: Hexagonal lock nut

Terminal block - Sub-bases

Operating pressure: 0,2 to 10 bar
 Operating temperature: -15°C to +70°C
 Storage temperature: -20°C to +70°C
 Body material: Thermo plastic

Main data for Speed Controls, PWR-L Series

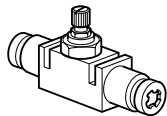

Symbol



With push-in connection knob adjustment and locknut

Push-in connection	Adjustment angle	Qmax input at 6 bar, l/min*	Weight g	Order code
4	13	200	20	PWR-L1444
6	12	400	40	PWR-L1466
8	15	720	60	PWR-L1488
10	18	1360	130	PWR-L1499
12	20	1950	150	PWR-L1411

* Screw closed

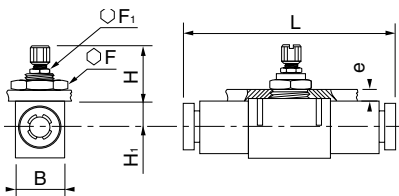

Order code	Dimensions (mm)								
	B	F	F1	e	H+	H-	H1	L	Q
PWR-L1444	12,0	14	*	6	25,5	21,5	6,5	39,0	10,5
PWR-L1466	17,0	19	*	7	32,5	27,5	7,5	54,0	17,0
PWR-L1488	18,5	24	11	7	34,5	28,5	9,0	60,5	19,0
PWR-L1499	24,0	30	14	7	38,5	29,5	11,5	76,0	25,0
PWR-L1411	28,0	32	14	8	42,0	32,0	12,5	86,0	28,0

Terminal Block Subbases for Cylinder Controls*

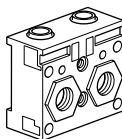

Dimensions

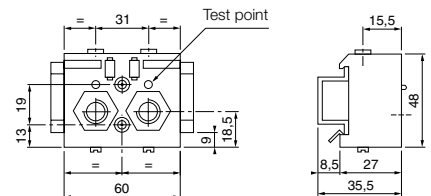

For Mounting Other Cylinder Controls	Push-in Connection Ømm	Bore Ømm	Weight g	Order code
G1/8	6	4	50	PZC-B2268
G1/4	8	6	50	PZC-B2289

* For remote mounting of all cylinder controls, when mounting on power valves or cylinders is impractical. The subbase is designed for mounting two components side by side.

- For direct cylinder mounting
- Blocker only or multifunction options
- Threaded or push-in ports
- Blocker/Flow Regulator device adjustable with manual barrel
- Wide range of sizes



Operating and additional information

Operating pressure:	1 to 10 bar
Permissible fluids:	Air or neutral gas 50micron or filtration, lubricated or not
Operating temperature:	-15°C to +60°C
Storage temperature:	-40°C to +70°C
No. of operations with dry air at 6 bar 20°C 1 Hz:	10 million
Maximum operating frequency:	10Hz
Vibration resistance:	According to IEC 68 - 2 - 6
Maximum connecting torque:	1/8 = 8Nm ; 1/4 = 12Nm; 3/8 = 30Nm; 1/2 = 35Nm
Body material (Blocker):	Zinc alloy
Body material (Blocker/Flow Regulator):	Thermo plastic
Connection thread:	Brass
Adjustment mode (Blocker/Flow Regulator):	Rotating barrel
Adjustment locking (Blocker/Flow Regulator):	Knurled lock nut
Internal seal at 6 bar:	≤ 0,6 l/h ANR

With Push-in Connection



Symbol

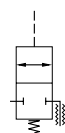

Connection for pilot port	Thread	Connection for tube, Ømm	Qmax input at 6 bar, l/min	Weight g	Order code
Push-in Ø4mm	G1/8	6	500	150	PWB-A1468
	G1/4	6	650	150	PWB-A1469
	G1/4	8	650	150	PWB-A1489
	G3/8	8	1600	180	PWB-A1483
	G3/8	10	1750	180	PWB-A1493
	G1/2	12	2050	500	PWB-A1412

With Threaded Connection



Symbol

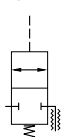

Connection for pilot port	Thread	Connection for tube, Ømm	Qmax input at 6 bar, l/min*	Weight g	Order code
Push-in Ø4mm	G1/8	G1/4	500	180	PWB-A1898
	G1/4	G1/4	650	180	PWB-A1899
M5*	G3/8	G3/8	1750	190	PWB-A1833
	G1/2	G1/2	2050	480	PWB-A1822

* Available with Ø4mm push-in connection, add 4 to the end of the Order code; example: **PWB-A18994**

With Push-in Connection, Barrel Adjustment and Locknut



Symbol

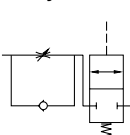

Connection for pilot port	Thread	Connection for tube, Ømm	Qmax input at 6 bar, l/min	Weight g	Order code
Ø4mm	G1/8	4	330	130	PWR-HB1448
	G1/8	6	500	130	PWR-HB1468
	G1/4	6	500	130	PWR-HB1469
	G1/4	8	600	130	PWR-HB1489
	G3/8	8	1200	180	PWR-HB1483
	G3/8	10	1300	180	PWR-HB1493
	G1/2	10	1400	130	PWR-HB1492

Blockers	Pilot				Depilot			
	operating pressure				operating pressure			
	2bar	4bar	6bar	8bar	2bar	4bar	6bar	8bar
PWB-A1898	3,1	3,5	4,0	4,5	0,8	1,0	1,2	1,4
PWB-A1899	3,1	3,5	4,0	4,5	0,8	1,0	1,2	1,4
PWB-A1833	2,5	2,8	2,9	3,4	1,1	1,3	1,6	1,9
PWB-A1822	2,5	2,8	2,9	3,4	1,1	1,3	1,6	1,9

Combined speed controllers & blockers	Pilot				Depilot			
	operating pressure				operating pressure			
	2bar	4bar	6bar	8bar	2bar	4bar	6bar	8bar
PWR-HB1448	3,1	3,5	4,0	4,5	0,8	1,0	1,2	1,4
PWR-HB1468	3,1	3,5	4,0	4,5	0,8	1,0	1,2	1,4
PWR-HB1469	3,1	3,5	4,0	4,5	0,8	1,0	1,2	1,4
PWR-HB1489	3,1	3,5	4,0	4,5	0,8	1,0	1,2	1,4
PWR-HB1483	2,5	2,8	2,9	3,4	1,1	1,3	1,6	1,9
PWR-HB1493	2,5	2,8	2,9	3,4	1,1	1,3	1,6	1,9

Blocker with push-in connection

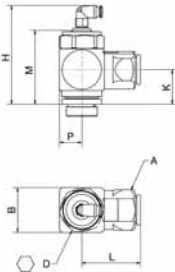

Order code	Dimensions (mm)							
	A	B	D	H	K	L	P	M
PWB-A1468	∅ 22	21	21	59,0	16,5	39	11	43
PWB-A1469	∅ 22	21	21	59,0	16,5	39	11	43
PWB-A1489	□ 22	21	21	59,0	16,5	39	11	43
PWB-A1483	□ 27	30	27	66,5	22,5	39	15	52
PWB-A1493	□ 27	30	27	66,5	22,5	39	15	52
PWB-A1412	27	30	27	66,5	22,5	39	15	52

Blocker with threaded connection

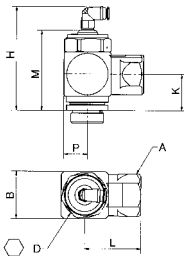

Order code	Dimensions (mm)								
	A	B	D	H	K	L	C	P	M
PWB-A1898	∅ 22	21	21	59,0	16,5	43,5	∅ 24	11	43
PWB-A1899	□ 22	21	21	59,0	16,5	43,5	∅ 24	11	43
PWB-A1833	□ 27	30	27	66,5	22,5	36,0	□ 27	15	52
PWB-A1822	27	30	27	66,5	22,5	36,0	□ 27	15	52

Blocker/Flow regulator

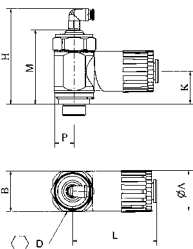

Order code	Dimensions (mm)						
	∅A	B	D	H	K	L	P
PWR-HB1448	22,5	21	21	59	16,5	47,0	12,5
PWR-HB1468	22,5	21	21	59	16,5	47,0	12,5
PWR-HB1469	22,5	21	21	59	16,5	47,0	12,5
PWR-HB1489	22,5	21	21	59	16,5	47,0	12,5
PWR-HB1483	29,0	30	27	64,5	22,5	60,0	15,0
PWR-HB1493	29,0	30	27	64,5	22,5	60,0	15,0
PWR-HB1492	29,0	30	27	64,5	22,5	60,0	15,0

- Detects stoppage of a cylinder due to a pressure drop in the exhaust chamber
- For direct mounting to cylinders
- Choice of pneumatic, electrical or electronic output
- Wide range of sizes



Operating and additional information

Operating pressure:	0 to 10 bar
Permissible fluids:	Air or neutral gas 50micron or filtration, lubricated or not
Operating temperature:	-15°C to +60°C
Storage temperature:	-40°C to +70°C
No. of operations with dry air at 6 bar 20°C 1 Hz:	10 million
Maximum operating frequency:	10 Hz
Output characteristics:	Pneumatic: Flow at 6 bar 90l/mn Electrical: C/contact 2.5A/250V AC, 5W 48V DC Electronic: PNP N/C or N/O 10 to 30V 75 mA DC
Maximum connecting torque:	M5 = 1Nm; 1/8 = 8Nm; 1/4 = 12Nm; 3/8 = 30Nm; 1/2 = 35Nm
Body material:	Thermo plastic
Connection thread:	Brass

Assembly

All back pressure sensors are a combination of two distinct parts: a banjo socket + a plug-in sensor.

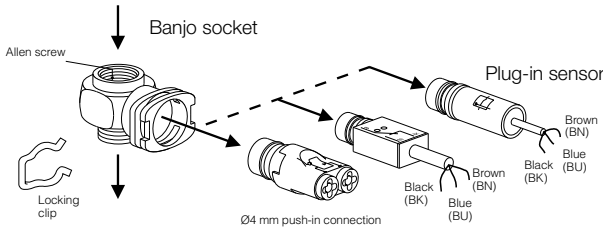

Connection

Output signal connection

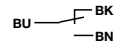

Pneumatic output sensor: Ø4 mm push-in

Electric output sensor

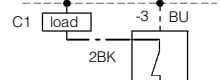

Solid state output sensor

Banjo Sockets

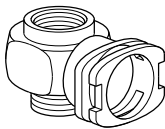

Thread Size for Cylinder Port	Female Thread	Tool Required	Weight g	Order code
M5	M5	8mm flat spanner	40	PWS-B155
G1/8	G1/8	5mm Allen key	40	PWS-B188
G1/4	G1/4	8mm Allen key	50	PWS-B199
G3/8	G3/8	10mm Allen key	70	PWS-B133
G1/2	G1/2	12mm Allen key	110	PWS-B122

Plug-in Sensors

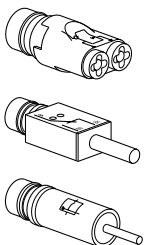

Sensing function	Output function	Output Connection	Output characteristics	Weight g	Order code
Exhaust back pressure decay	Pneumatic	Push-in Ø4mm	NO valve flow rate at 6 bar 90 l/mn	90	PWS-P111
	Electrical -Ve = 3A	3 wires 0,5mm ² length 2m	CO contact 12 to 230V ~ / 10VA* 12 to 48 VDC/5W*	80	PWS-M1012
	Solid state	3 wires 0,1mm ² length 2m	PNP type NC 10/30VDC** 75 mA, NO	70	PWS-E101
				70	PWS-E111

* Suitable for low currents : 250 V ~ / 4 mA ; 24 VDC / 10 mA ** Including ripple

- Detects stoppage of a cylinder due to a pressure drop in the exhaust chamber
- Single unit design
- For direct mounting to cylinders
- Pneumatic output
- Wide range of sizes



Operating and additional information

Operating pressure:	0 to 10 bar
Permissible fluids:	Air or neutral gas 50micron or filtration, lubricated or not
Operating temperature:	-15°C to +70°C
Storage temperature:	-20°C to +70°C
No. of operations with dry air at 6 bar 20°C 1 Hz:	10 million
Maximum operating frequency:	1 Hz
Output characteristics:	Flow @ 6 bar 90l/m
Maximum connecting torque:	M5 = 1Nm; 1/8 = 8Nm; 1/4 = 12Nm; 3/8 = 30Nm; 1/2 = 35Nm
Body material:	Zinc alloy / Thermo plastic
Connection thread:	Brass

Plug-in & Monoblock back pressure sensors	Pilot	Depilot
	operating pressure 6 bar	operating pressure 6 bar
PWS-P111	4,4	0,4
PWS-M1012	1,5	0,6
PWS-E101 & E111	1,5	0,6
PWS-C	1,6 ±0,2	0,3

Back Pressure Sensor for Cylinder Mounting

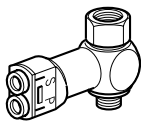

Symbol



Thread Cylinder Port	Thread Supply Port	Bore Ømm	Weight g	Order code
M5	M5	2	100	PWS-C5145
G1/8	G1/8	5	110	PWS-C5148
G1/4	G1/4	7	100	PWS-C5149
G3/8	G3/8	10	170	PWS-C5143
G1/2	G1/2	14	150	PWS-C5142

Back Pressure Sensors - Mono block

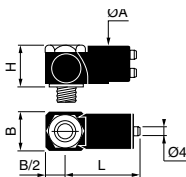

Order code	Dimensions (mm)			
	ØA	B	H	L
PWS-CS145	19	11,0	16,0	42
PWS-CS148	22	16,5	29,0	40
PWS-CS149	22	23,5	26,0	43
PWS-CS143	22	23,5	36,5	43
PWS-CS142	22	32,0	29,5	48

Back Pressure Sensors - Modular

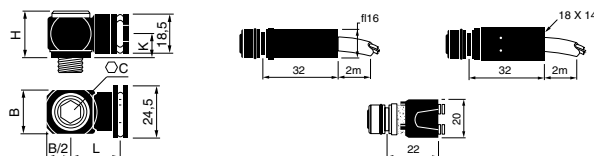

Order code	Dimensions (mm)				
	C	B	H	K	L
PWS-B155	8	11	16,5	10	17
PWS-B188	5	16	20,0	10	20
PWS-B199	8	21	20,0	10	22
PWS-B133	10	28	22,0	12	25
PWS-B122	12	33	26,0	14	26

- Adjusts the actuating force developed by a cylinder
- For direct mounting to power valve
- Threaded or push-in ports
- Adjustment by allen key or knurled knob
- Wide range of sizes



Operating and additional information

Operating pressure:	1 to 8 bar
Permissible fluids:	Air or neutral gas 50micron or filtration, lubricated or not
Operating temperature:	-15°C to +70°C
Storage temperature:	-20°C to +70°C
Maximum connecting torque:	1/8 = 8Nm ; 1/4 = 12Nm; 3/8 = 30Nm
Body material:	Zinc alloy
Connection thread:	Brass
Adjustment mode:	Allen key

With Push-in Connection

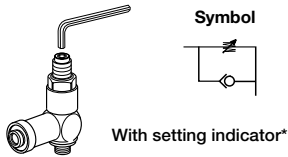

Thread size for cylinder port	Push-in Connection, Ømm	Qmax input at 6 bar, l/min*	Weight g	Order code
G1/8	6	570	300	PWP-B1268
G1/4	6	530	300	PWP-B1269
G1/4	8	870	300	PWP-B1289
G1/4	10	1400	540	PWP-B1299
G3/8	10	1530	550	PWP-B1293

* Adjustment is carried out using a 6mm Allen key or a knurled knob.

With Threaded Connection

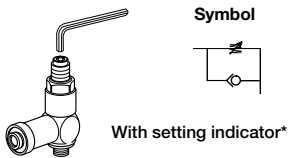

Thread size for cylinder port	Push-in Connection, Ømm	Qmax input at 6 bar, l/min*	Weight g	Order code
G1/8	G1/8	570	340	PWP-B1888
G1/4	G1/4	870	340	PWP-B1899
G3/8	G3/8	3200	620	PWP-B1833

* Adjustment is carried out using a 6mm Allen key or a knurled knob.

Clip-in knurled adjustment knob for optimisers

Weight g	Order code
30	PWP-Z13

Dimensions (mm)

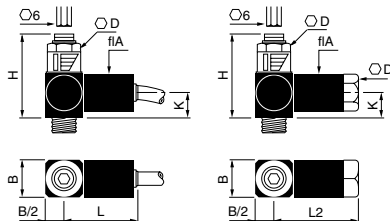

Order code	ØA	B	D	H	K	L	L2
PWP-B1268	22	21	19	58,0	13,5	39	
PWP-B1269	22	21	19	58,0	13,5	39	
PWP-B1289	22	21	19	58,0	13,5	39	
PWP-B1299	27	28	19	65,5	16,5	50	
PWP-B1293	27	28	27	65,5	16,5	50	
PWP-B1888	22	21	19	58,0	13,5		43
PWP-B1899	22	21	19	58,0	13,5		43
PWP-B1833	27	28	27	65,5	16,5		55

- Enables a gradual increase in pressure
- For direct mounting to power valve
- Instant push-in connections
- Adjustment by allen key



Operating and additional information

Operating pressure:	3 to 10 bar
Permissible fluids:	Air or neutral gas
Operating temperature:	-15°C to +70°C
Storage temperature:	-20°C to +70°C
No. of operations with dry air at 6 bar 20°C 1 Hz:	1/4 : 10 million; 3/8 : 5 million
Maximum operating frequency:	1 Hz
Maximum connecting torque:	1/4 = 12Nm; 3/8 = 30Nm
Body material:	Thermo plastic
Connection thread:	Brass
Adjustment mode:	Allen key

With Push-in Connection

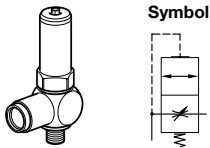

Thread	Push-in Connection, Ømm	Flow rate at 6 bar, l/min	Weight g	Order code
G1/4	8	1500	70	PWD-P2489
G1/4	10	2000	120	PWD-P2499
G3/8	10	2000	130	PWD-P2493

Dimensions (mm)

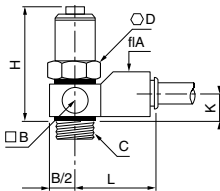

Order code	ØA	B	ØC	D	H maxi	K	L
PWD-P2489	15,0	20	G1/4	17	61	8,5	27,5
PWD-P2499	19,5	25	G1/4	22	62	11,8	41,0
PWD-P2493	19,5	25	G3/8	22	62	11,8	41,0

Operation

A Soft starter provides a progressive increase in pressure, in a section of a pneumatic system. When pressure reaches half the supply pressure, full pressure is applied automatically.

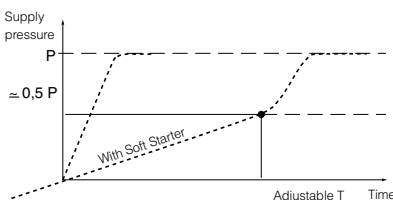

Adjustment

Allen key adjustment of flow rate for slow pressure increase.

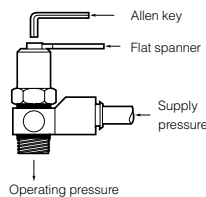

Mounting

These compact devices with push-in tube connection are fitted to the N°1 port of the power valve.

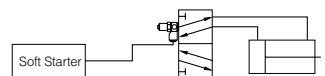

- Increases piston speeds, super sensitive diaphragm
- Extremely low operating differential
- Virtually stiction free
- May be used as differential shuttle valve
- High temperature option



Operating and additional information

Operating pressure: 0,2 to 10 bar
 Operating temperature (Standard): -10°C to +80°C
 Operating temperature (High): -10°C to +180°C
 Body material: Aluminium
 Diaphragm material (Standard): Nitrile
 Diaphragm material (High): Viton

Standard version

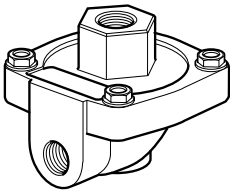
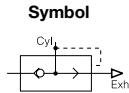

Port Size	Cv Rating	Weight g	Order Code
G1/4	2,3	200	P4Q-BA12
G3/8	3,6	180	P4Q-BA13
G1/2	6,6	500	P4Q-CA14
G3/4	7,3	440	P4Q-CA16

High temperature version

Port Size	Cv Rating	Weight g	Order Code
G1/4	2,3	200	P4Q-BV12
G3/8	3,6	180	P4Q-BV13
G1/2	6,6	500	P4Q-CV14
G3/4	7,3	440	P4Q-CV16

Quick Exhaust Valves

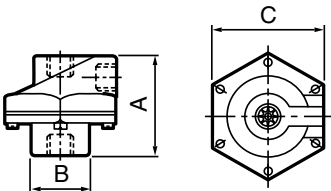

Order code	Port Size	Dimensions (mm)		
		A	B	C
P4Q-B*12	G1/4	52	25	62
P4Q-B*13	G3/8	52	25	62
P4Q-B*14	G1/2	73	38	86
P4Q-B*16	G3/4	73	38	86

- Aluminium bodies
- Rugged brass body design
- Standard or high temperature options
- Long life
- Low 0,1 bar operating pressure
- Full flow in one direction only
- Instant push-in connections



Operating and additional information

Non return valves - Female - VB

Operating pressure: 0,1 to 10 bar
 Operating temperature: -20°C to +70°C
 Body material: Anodised aluminium
 Seal material: Nitrile

Non return valves - Push-in - PWA

Operating pressure: 0,2 to 10 bar
 Operating temperature: -15°C to +70°C
 Storage temperature: -20°C to +70°C
 Body material: Thermo plastic

Non return valves - Male thread - 3047

Operating pressure: 0,1 to 17 bar
 Flow: Qmax at 6 bar, l/min*
 1/8 = 1200L/m;
 1/4 - 1350 L/m
 Operating temperature:
 Standard: -26°C to +85°C
 High: -26°C to +230°C
 Body material: Brass
 Seal material: Standard: Nitrile
 High: Viton

VB Series

VB - Aluminium

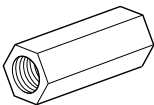

Symbol



Port size	Weight g	Order code
G1/8	10	VB12-Q-NQ-5
G1/4	10	VB22-Q-NQ-5
G1/2	50	VB42-Q-NQ-5

Dimensions (mm)

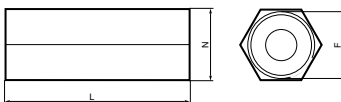

Order code	F	L	N
VB12-Q-NQ-5	G1/8	31	14
VQB22-Q-NQ-5	G1/4	40	17
VB42-Q-NQ-5	G1/2	59	27

PWA Series

Line Mounted

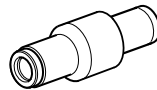

Symbol



Sold in lots of 10

Push-in Connection Ømm	Flow Rate at 6 bar, l/min	Order code
4	200	PWA-L1444
6	660	PWA-L1466
8	1600	PWA-L1488

Dimensions (mm)

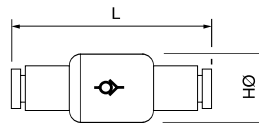

Order code	ØH	L
PWA-L1444	16,0	38,5
PWA-L1466	16,0	41,0
PWA-L1488	19,0	51,5

3047 Series

Standard version



Symbol



Thread Size	Weight g	Order code
R1/8	68	3047X
R1/4	72	3047B

High temperature version



Symbol



Thread Size	Weight g	Order code
R1/8	68	3047XV
R1/4	72	3047BV

Dimensions (mm)

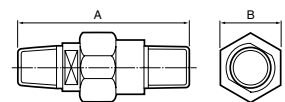

Order code	Port Size	A	B
3047X/XV	R1/8	51	21
3047B/BV	R1/4	49	21

- Allows two separate signals to be applied to the air pilot
- 0,6 bar differential, Viton seals as standard



Operating and additional information

Operating pressure: 1,3 to 17 bar
 Operating temperature: -10°C to +60°C
 Body material: Aluminium
 Shuttle ball material: Plastic

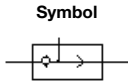
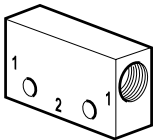

Port Size	Qmax input at 6 bar, l/min	Weight g	Order Code
M5	36	40	M33005
G1/8	509	100	B43005B
G1/4	1076	172	B53005A

Shuttle Valves

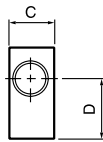
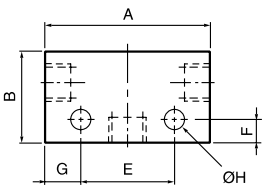

Order code	Port Size	Dimensions (mm)							
		A	B	C	D	E	F	G	H
M33005	M5	27,5	24	15	16,0	15	6	6,3	3,2
M43005B	G1/8	44,0	24	15	16,0	25	6	9,5	4,5
B53005A	G1/4	52,0	30	22	20,5	35	10	8,5	5,5

- Twistlok action
- Wide choice of adaptors
- Non whip adaptors
- Rugged design



Twistlok Units

Designed for single hand connection or disconnection. A twist on the cap will release the adaptor and the airline is automatically resealed. When coupled the check unit allows the adaptors to swivel, to eliminate kinking of the hose.

Operating and additional information			Materials	
Pressure range	Standard Partial vacuum to 17 bar	Heavy Duty Partial vacuum to 17 bar	Body	Aluminium
Temperature range	-10°C to +80°C	-10°C to +80°C	Washer holder	Brass chrome plated
Fluids	Air	Air	Spring	Stainless steel
Q max	23.6 dm³/s	51.9 dm³/s	Deflector	Brass
Cv	1.07	1.9	Sleeve	Steel zinc plated
			Seals	Nitrile (viton on request)
			Adaptors	Plated mild steel

Flow Rates

Pressure vs Flow
Schrader Standard 1/4 Female Coupling

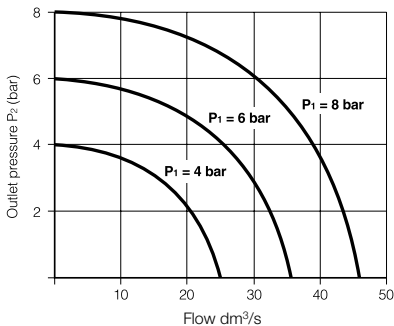

Pressure vs Flow
Schrader Heavy Duty 1/2 Female Coupling

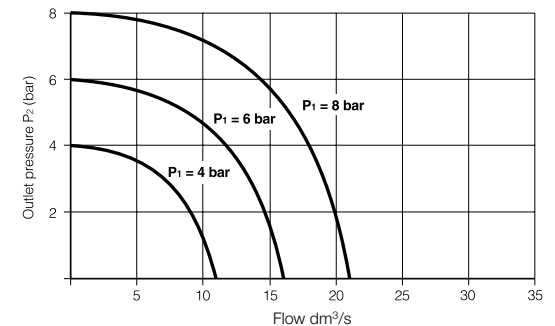

Twistlok Standard Check Units



Profile



Symbol

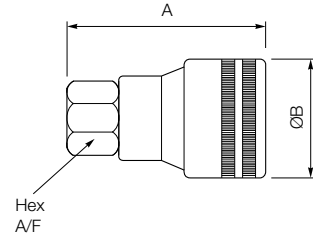
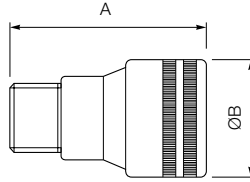

Order Code	Pack Qty	Connection	Weight (g)	Dimensions (mm)		
				A	ØB	Hex A/F
8952DL-12	1	G1/4 Female (BSPP)	120	45	30	17,5
9793D-12	1	R1/4 Male (BSPT)	132	55	30	18,0
9792D-12	1	R3/8 Male (BSPT)	138	55	30	18,0

Standard Adaptors



Profile



Symbol

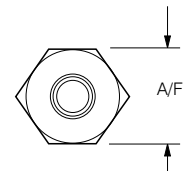
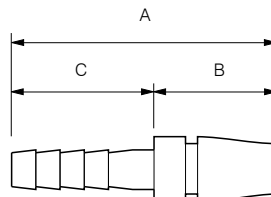
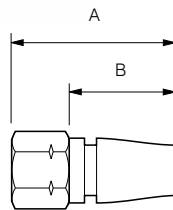
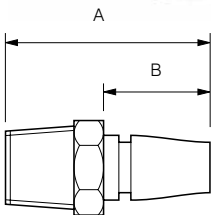
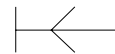

Order Code	Pack Qty	Connection	Weight (g)	Dimensions (mm)			
				A	B	C	Hex A/F
8051B-11	1	R1/8 Male (BSPT)	15	42	24,5	-	14,0
8050B-11	1	R1/4 Male (BSPT)	20	44	24,5	-	14,0
2047B	1	G1/8 Female (BSPP)	26	42	24,5	-	14,0
8278L-11	1	G1/4 Female (BSPP)	34	46	31,0	-	17,5
8787-11	1	1/4" (6mm)	22	57	30,0	27	14,0
9750-11	1	5/16" (8mm)	24	57	30,0	27	14,0
8788-11	1	3/8" (10mm)	24	57	30,0	27	14,0
9031	1	G1/4 Female Non-whip (BSPP)	48	55	31,0	-	17,5

**Twistlok Heavy Duty
Check Units**

Profile

Symbol

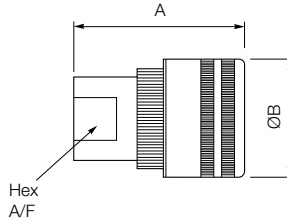

Order Code	Pack Qty	Connection	Weight (g)	Dimensions (mm)		
				A	ØB	Hex A/F
1054EL-12	1	G1/4 Female (BSPP)	168	58	37	17,5
1095EL-12	1	G3/8 Female (BSPP)	160	58	38	24,0
1461EL-12	1	G1/2 Female (BSPP)	180	58	37	25,5
1462EL-12	1	G3/4 Female (BSPP)	220	63	37	33,0

Heavy Duty Adaptors

Profile

Symbol

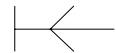
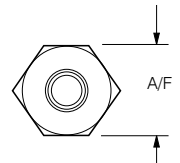
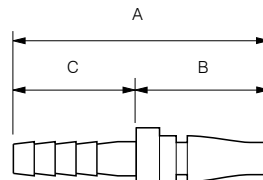
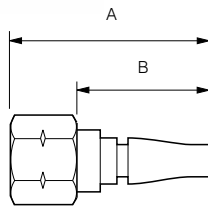
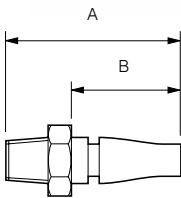

Order Code	Pack Qty	Connection	Weight (g)	Dimensions (mm)				
				A	B	C	Hex A/F	
8624B-11	1	R1/4 Male (BSPT)	44	48,0	28	-	17,5	
9739-11	1	R3/8 Male (BSPT)	60	48,0	28	-	22,0	
8807-11	1	R1/2 Male (BSPT)	86	54,0	28	-	22,0	
1462B-11	1	G3/4 Male (BSPP)	102	55,0	28	-	27,0	
1261L-11	1	G1/4 Female (6mm)	44	43,0	28	-	17,5	
1096B-11	1	G3/8 Female (8mm)	64	47,0	28	-	22,0	
1097-11	1	3/8" (10mm)	Hose Tail	46	71,0	33	38	-
1098-11	1	1/2" (12mm)	Hose Tail	64	71,0	33	38	-
9042	1	G3/8 Female Non-whip	(BSPP)	90	57,5	28	-	22,0

- Ideal when space is at a premium
- Male or female threads
- Two hand operation



The sleeve action design requires two hand operation for added security, before the adaptor is connected. On disconnection the check unit automatically reseals the airline. When coupled the check unit allows the adaptors to swivel to eliminate kinking of the hose.

Operating and additional information		Materials	
Pressure range	0-16 bar	Body	Brass nickel plated
Temperature range	-10° to +80°C	Spring	Stainless steel
Fluids	Air	Balls	Stainless steel
Flow rate	Q max = 17.9 dm ³ /s Cv = 0.57	Seals	Nitrile
		Adaptors	Brass nickel plated

Typical Flow Rates

**Pressure vs Flow
Schrader Mini 1/4 Male Coupling**

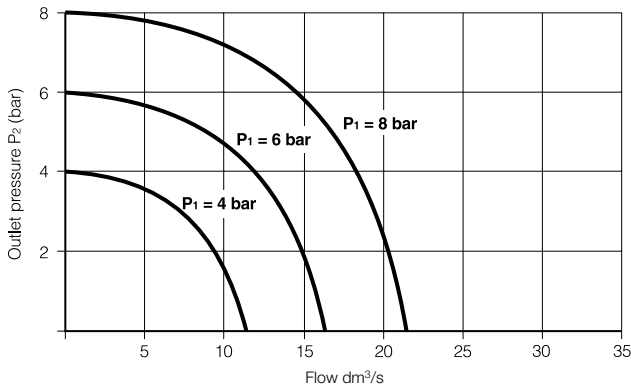

Mini Check Units



Profile



Symbol

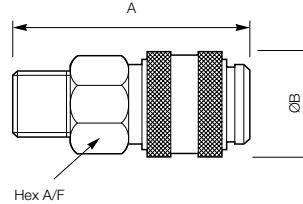
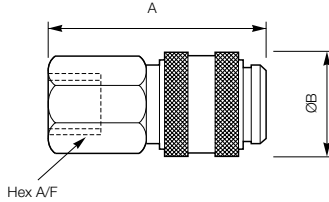

Order Code	Pack Qty	Connection	Weight (g)	Dimensions (mm)		
				A	ØB	Hex A/F
7073	1	G1/8 Female (BSPP)	28	36,5	16,5	14
7071	1	G1/8 Male (BSPP)	28	36,5	16,5	14

Mini Adaptors



Profile



Symbol

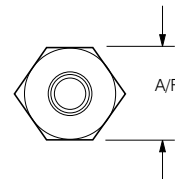
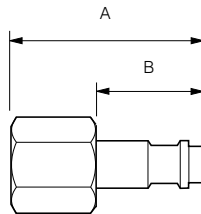
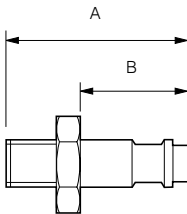
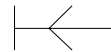

Order Code	Pack Qty	Connection	Weight (g)	Dimensions (mm)		
				A	ØB	Hex A/F
7370	5	G1/8 Female (BSPP)	16	27	14	14
7170	5	G1/8 Male (BSPP)	12	25	14	14

- All plastic ultra light weight versions
- Sintered metal
- All metal versions for heavy duty applications
- Versions with push-in connections
- High noise level reduction
- Low back pressure generation



Operating and additional information

Plastic	Working temperature: -10°C to +80°C		
	Efficiency 92%		
Metal	Working temperature: -10°C to +74°C	Working pressure	up to 17 bar

P6M-P Plastic Series

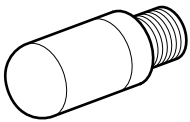

Symbol

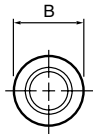
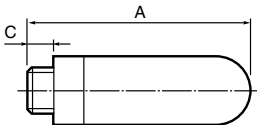

Port thread	Dimensions (mm)			Weight g	Order code
	A	Ø B	C		
M5	23	6,5	4	0,01	P6M-PAC5
G1/8	29	14	6	0,02	P6M-PAB1
G1/4	34	17	6	0,04	P6M-PAB2
G3/8	60	25	9	0,06	P6M-PAB3
G1/2	64	25	11	0,10	P6M-PAB4
G3/4	140	38	14	0,50	P6M-PAB6
G1	160	48	20	0,62	P6M-PAB8

Push-in Series



Symbol



Port mm	Height on Push-in	Weight g	Order code
4	20,0	0,040	PXC-X14
6	35,5	0,025	PZC-S1006
8	34,0	0,030	PZC-S1008

Sintered bronze Series

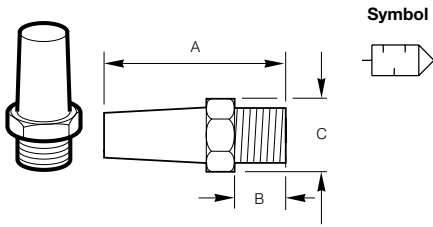

Port thread	A	B	A/F C	Weight g	Order code
M5	23	6,5	4	0,003	9721900005
G1/8	24	10	12	0,009	9090050700
G1/4	32	11	16	0,019	P6M-BAA2
G3/8	43	13	21	0,041	9090050900
G1/2	60	16	24	0,068	9090051000
G3/4	75	10	32	0,126	9090051100
G1	77	12	37	0,188	9090051500

Sintered Bronze Series (female)

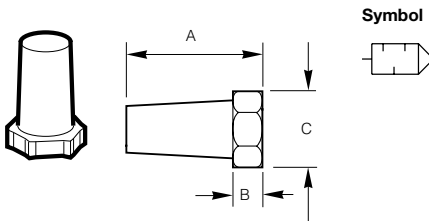

Port mm	A	Ø B	A/F C	Weight g	Order code
G1/8	15	8	13	0,060	9721900404

Heavy Duty Series

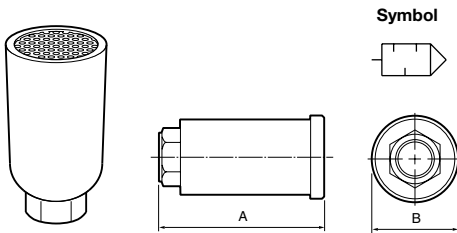

Port Female	A	Ø B	Weight g	Order code
G3/8	83	37	0,124	P6M-MA13
G1/2	105	51	0,362	P6M-MA14
G3/4	143	73	0,670	P6M-MA16
G1	143	73	0,666	P6M-MA18

Self Cleaning, 48 Series

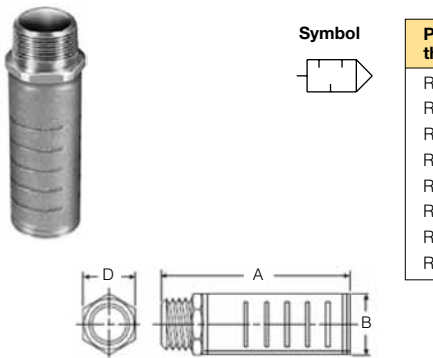

Port thread	A	Ø B	A/F E	Order code
R1/8	47	21	16 (5/8")	ESB12MC
R1/4	47	21	16 (5/8")	ESB25MC
R3/8	84	32	25.4 (1")	ESB37MC
R1/2	84	32	25.4 (1")	ESB50MC
R3/4	116	52	41.2 (1-5/8")	ESB75MC
R1	116	52	41.2 (1-5/8")	ESB100MC
R1-1/4	145	73.5	-	ESB125MC
R1-1/2	145	73.5	-	ESB150MC

Restrictors - Silencers

- Metal, stainless steel or plastic versions
- Screwdriver adjustment
- Simple control of cylinder speeds
- High noise level reduction



Sintered Metal Series

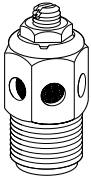

Symbol



Port thread	Overall length	A/F	Order code
R1/8	29.5	9/16"	43006
R1/4	36.0	1/2"	T53006
R3/8	38.0	11/16"	T63006A
G1/2	45.0	7/8"	B73006

Sintered Plastic Series

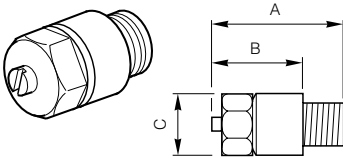

Symbol



Port thread	A	B	Ø C	Order code
G1/8	23	16	7	9301050901
G1/4	32	23	9	9301050902
G3/8	40	30	10	9301050903
G1/2	50	38	12	9301050904

Sintered Stainless Steel Series

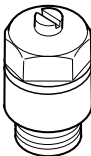

Symbol



Port thread	Overall length	Ø	A/F	Order code
G1/8	33	16	13,0	9126900195
G1/4	36	20	17,0	9126900196

Reclassifier - Silencers Metal Series, Repairable and Disposable versions

- Removes oil mist from exhaust airs
- Efficiently silences exhaust air
- Improves working conditions



Operating and additional information

Metal repairable version

Working temperature	0 °C to 66 °C max.
Working pressure	Max 7 bar
Efficiency	Better than 99%
Maximum flow rate	G1/2, G3/4 small unit 27,8 dm ³ /s G3/4, G1 large unit 50 dm ³ /s

Disposable version

Working temperature	0° C to 52 °C max.
Working pressure	Max 7 bar
Efficiency	Better than 99%
Maximum flow rate	See graph

Disposable version
Flow vs. Noise level

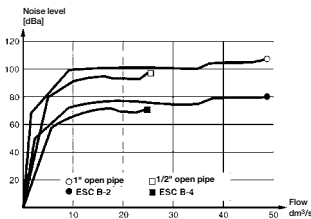

Flow vs. Back pressure

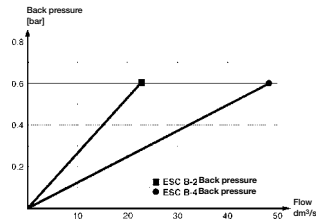

Metal Repairable Series

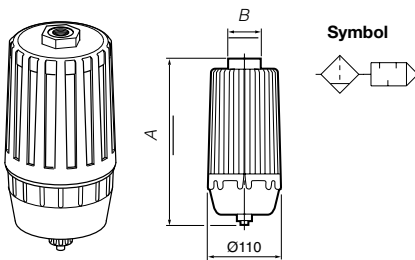

Port thread	Type	A	Ø	A/F B	Weight kg	Order code
G1/2	Small	182	110	50	0,572	3514S
G3/4	Small	182	110	50	0,592	3516S
G3/4	Large	297	110	55	1,100	3516
G1	Large	297	110	55	1,100	3518

Replacement Element	Weight kg	Order code
Small	0,200	3514S-2
Large	0,200	3516-2

Manifold for Metal Repairable version

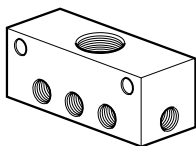

Number of ports	Weight kg	Order code
5	0,270	M3516-5
7	0,432	M3516-7
9	0,574	M3516-9
13	0,870	M3516-13

The manifold is available for G3/4 sizes only.

Wall mounting kit	0,040	3516-W
--------------------------	-------	---------------

- 2 different types for various applications
- Different types of safety nozzle available
- Ergonomically designed
- Lightweight operating forces





Operating information





Blowguns 600

Working pressure Max 7 bar
 Working temperature -20 °C to +100 °C

600-601

Symbol	Note	Inlet Thread	Order code
	Standard Safety	G 1/4	600
	Air shield	G 1/4	601

Accessories

Type	Description	Order code
	Aluminium nozzle with 1mm orifice*	607
	Aluminium nozzle, blank*	606
	Domed nozzle*	8972-8
	Aspirator Safety nozzle	401C
	Flexible nozzle*	8726A

* **Note!** When used with pressure above 2 bar, adequate safety precautions must be taken.

Control Devices

A complete range of pneumatic valves



Parker is the world leader in motion and control technologies, providing systematic, precision-engineered solutions for a wide variety of, industrial markets. Throughout the world, Parker Hannifin is working together with companies to make their machines more reliable and more productive. Parker products are in operation on satellites orbiting the earth: in machine tools and mobile plant; on oil rigs and refineries; in hospitals and laboratories. In fact, wherever there are machines that depend on motion or fluid control, you will find innovative and reliable Parker components and systems. The Parker range of control devices is much more than just valves, we have within our product programme field bus enabled valve systems, limit switches, logic process components, two hand control units, metal valves for arduous applications and ultra lightweight plastic valves.

General Lightweight Applications & Individual/ Multiple Field Bus Connections

P2M Moduflex Valves



- High flow, compact size.
- Mixable valve sizes.
- Stand alone valves, modular islands with individual, multiconnector or bus connections.
- Integrated selectable internal or external pilot supply and exhaust.
- Optional peripheral modules.
- Push-in connection.

Valve Islands

PVL-C10



- Compact lightweight, high flow valves
- 2 x 3/2, 5/2 or 5/3 configuration
- Push-in Ø8mm or G1/4 threaded connections
- High performance 15mm solenoids
- Stacking type modules with DIN rail mounting
- Bus protocols: Interbus S, Profibus DP, Devicenet, ASI.

Miniature Valves

ADEX Directional Control Valves



- 2 sizes: M5 and 1/8"
- Compact body with large flow
- Quick response time, faster than 10ms
- Expected life time more than 50,000,000 cycles
- Low power consumption only 0.6W
- Optional multipin connector manifold
- Manual override

Stackable Inline Lightweight Valve

Interface 2000



- 3/2 or 4/2 configuration
- Push-in connections Ø4mm and Ø6mm
- High performance 15mm solenoids
- Electrical connection : Cable gland, Sub D25 or Industrial connector
- Bus protocols: Interbus S, Profibus DP, Devicenet, ASI.

Poppet Valve for Enclosures

PS1 Interface



- High speed poppet valve
- Push-in connection
- Built-in terminal block
- Pneumatic output indicator
- DIN rail mounting

Industrial Applications

B Series Valves



- 2 sizes: 1/8" and 1/4"
- Compact size
- Inlet-exhaust-mounting facility
- Fast response, high flow
- Integrated mounting holes
- Wear compensating seal system
- DIN rail mountable manifolds

Valve Islands

PVL-B10



- Compact lightweight, high flow valves
- 2 x 3/2, 5/2 or 5/3 configuration
- Push-in Ø6mm or G1/8 threaded connections
- High performance 15mm solenoids
- Stacking type modules with DIN rail mounting
- Bus protocols: Interbus S, Profibus DP, Devicenet, ASI.

Stackable Inline Lightweight Valve

PVL Compact Valves



- High flow, compact size
- Push-in or threaded connection
- DIN rail or block mounting
- Light weight construction

Heavy Duty Applications / Mobile

Viking Xtreme Metal Spool Valves



- 4 sizes: G1/8, G1/4, G3/8 and G1/2.
- Wide operating temperature range
- Compact design with good corrosion resistance.
- Wide range of 5/2 and 5/3 versions.
- High and low temperature versions available for transport applications.

Heavy Duty Applications / Multiple Connection and Plug-in

Isomax Valves - ISO 15407 / ISO 5599



- Size 1, 2 and 3 ISO 5599-1
- Size 01 and 02 (26 and 18 mm) ISO 15407-1
- Ceramic technology for long live operation
- From vacuum up to 12 bar applications
- Internal or external pilot supply with same valves
- Pressure supply possible on exhaust port

ISYS Valves - ISO 15407 / ISO 5599



- Size 1, 2 and 3 ISO 5599-1 / 2
- Size 01 and 02 ISO 15407-1 / 2
- Excellent reliability, long life in excess of 30 million operations.
- Complete range, plug-in and non-plug-in
- WCS Spool technology

Hi Flow Valves

P2V Flowstar Valves ISO 15407-1



- Compact high flow design
- To VDMA 24563, ISO 15407-1 standard
- 5/2 & 5/3 configurations
- 18mm & 26mm body widths
- Single sub-base or manifold mounted
- Air pilot and solenoid actuators
- Suitable for Food Industry applications.

Ceramic Valves

PVD Everdure



- Available in 3 sizes
- 4/2 Directional control valves
- 3/2 dump valves & 2/2 slow start valves
- Stand alone or manifolds.
- Built-in manual override
- Ceramic slide provides extremely long life
- DIN rail mounting.

Metal Spool Valves

Midget Spool Valves



- G1/8 body ported
- Rugged die cast body
- 3/2 & 5/2 configurations
- Stainless steel spool
- Viton body seals as standard
- Integral mounting holes
- Manual, mechanical and automatic actuators.

Metal Spool Valves

Intermediate Spool Valves



- G1/4 body ported
- Rugged die cast body
- 3/2, 5/2 & 5/3 configurations
- Stainless steel spool
- Viton body seals as standard
- Integral mounting holes
- Manual, mechanical and automatic actuators.

Push Button Actuators

PXB Push Buttons



- Facia mounted operators
- 3/2 NO or NC versions
- Pneumatic valves combinable with electrical switches
- Modular construction
- Wide choice of actuators.

Heavy Duty Applications

VA - Brass bodied spool valves



- Rugged valves for heavy duty applications
- Large and robust actuators for easy operation
- Excellent corrosion resistance
- Integral mounting holes
- Panel mounting versions

Limit Switches

PXC Limit Switches



- 3/2 Nc spring return as standard
- Ø4mm, M5 & G1/8 ported versions
- Miniature and Compact designs
- Wide choice of actuators include levers, rollers & ultra light whisker types.

Metal Poppet Valves

Mini Poppet Valves



- M5 body ported
- 3/2 NC spring return as standard
- Manual and mechanical actuators
- Light actuation forces.

Midget Poppet Valves



- G1/8 body ported poppet design
- 3/2 NC spring return as standard
- Manual, mechanical and air pilot actuators
- Light actuation forces
- Integral mounting holes.

Heavy Duty Poppet Valves



- G3/8 & G1/2 body ported
- 2/2 & 3/2 NC spring return as standard
- High flow poppet design
- Manual and mechanical and solenoid actuators
- Light actuation forces
- Integral mounting holes.

Heavy Duty Valves

VE Heavy Duty Isolator Valves



- G1/4, G1/2 & G1 versions
- 2/2 or 3/2 option
- Inline installation
- High flow
- Suitable as a remotely controlled main shut off valve.
- Air or solenoid pilot

Lockout Valves

LV Series Lockout Valves



- G1/4 - G1 Ported emergency shut-off valves
- High flow G1 exhaust port
- Manually operated
- High visibility, rugged aluminium body
- Detented spool with padlock 'lockout' facility.

Processing Modules

Two Hand Control Units



- Ergonomic design
- Robust polymer or metal enclosure
- Meets requirements for protection against accidental operation and tampering
- Metal enclosure features a wrist rest bar which prevents illness due to repetitive actions
- Conforms to EN574 and EN954-1 requirements

Shut Off Valves

Ball Valves and Sliding Sleeve Valves



Ball Valves

- 3 distinct series
- Vented and non vented
- Bubble tight shut-off
- Positive 90 ° movement
- Wide variety of fluids

Sliding sleeve valves

- Linear sleeve operated
- 3/2 valve
- Simple airline isolation
- Compact
- Minimum space for valve operation

Processing Modules

Logic Control



- Complete range of logic processing modules
- Stand alone or stackable and combinable units
- Ultra fast response times
- Visual indication
- DIN rail mounting.

Vacuum Products

A complete range of vacuum products and accessories

Vacuum Products
A complete range of vacuum products and accessories

Parker

CONVUM

Parker is the world leader in motion and control technologies, providing systematic, precision-engineered solutions for a wide variety of, industrial markets. Throughout the world, Parker Hannifin is working together with companies to make their machines more reliable and more productive. Parker products are in operation on satellites orbiting the earth: in machine tools and mobile plant; on oil rigs and refineries; in hospitals and laboratories. In fact, wherever there are machines that depend on motion or fluid control, you will find innovative and reliable Parker components and systems.

The Parker Convum range of vacuum products is one of the most comprehensive in the market. The product range includes vacuum cups in wide variety of styles and materials, ejectors and generators from mini units to fully integrated units along with sensors and a wide selection of accessories.

Wide choice of styles and materials

Ventouses



- Flat & Bellows Pads
- Male & Female Connections
- Different Materials
- Range of Diameters

High performance accessories

Accessoires



- High performance silencers and vacuum filters
- Electronic cables with M8 connector 4 pin

Vacuum generators to suit most applications

Générateurs de vide



- Basic Ejectors
- Basic Ejectors with electro-mechanical Switch
- In-line Ejectors
- Integrated Ejectors small & large

Digital or analog out put

Vacuostats et pressostats



- -1 to +10 bar
- Analog and/or Digital Outputs
- With display

Rotary Actuator and Air Motor Products

A complete range of rotary actuator and air motor products

Parker is the world leader in motion and control technologies, providing systematic, precision-engineered solutions for a wide variety of, industrial markets. Throughout the world, Parker Hannifin is working together with companies to make their machines more reliable and more productive. Parker products are in operation on satellites orbiting the earth; in machine tools and mobile plant; on oil rigs and refineries; in hospitals and laboratories. In fact, wherever there

are machines that depend on motion or fluid control, you will find innovative and reliable Parker components and systems.

The Parker range of rotary actuators and airmotors offers a choice of oscillating or continuous rotary motion. Stainless steel versions specifically for food industry or more robust models for general industrial applications are available.

Rotary Actuator and Air Motor Products

Harsh Environments & Food Industry

P1V-S Air Motors



- All stainless steel design
- From 0.120kW - 1.2kW power
- For arduous applications
- Non-lube intermittent operation
- External seals viton
- Ideal for food industry applications.

Arduous Applications

P1V-B Large Vane Air Motors



- Power 5, 1 kW, 9 kW and 18 kW
- For the very heavy applications
- Free speed from 400 up to 300 rpm
- High torque from 57 to 160 Nm by max output power

Packaging, Process, Electronic Applications

PRO-PRN Rotary Actuators



- Compact design
- Durable construction
- Long maintenance-free life
- High output torque/weight ratio
- Wide choice of torques available (up to 247 Nm)

Minimum Noise Level

P1V-P Radial Piston Air Motors



- P1V-P piston motor
- Power 0.73 kW, 0.125kW and 0.228kW
- Low speed and high torque
- Available as base and brake motors
- Free speed from 2200 down to 7.4 rpm
- High torque from 0.637Nm up to 500Nm

Arduous Applications

P1V-A Large Air Motors



- Designed for arduous applications.
- Wide range of optional gears
- Wide speed and torque range 1.6kW, 2.6kW, 3.6kW

Rack and Pinion Piston Rods

RA Rotary Actuators Rack & Pinion Type



- High torque
- Uniform torque in both directions
- Compact design
- 90° or 180° rotation
- Output shaft with key

Robust Air Motor

P1V-M Robust Vane Air Motors



- Power 0.2 kW, 0.4 kW and 0.6 kW
- Patented way for simple change of vanes
- Free speeds from 28 up to 10000 rpm
- Torque from 0.38 Nm up to 380NM by max output power
- Standard equipped with flange mounting
- Footmountings as accessories

Heavy Duty Applications

P5W Rotary Table Units



- Rack and pinion patented movement.
- Continuously adjustable stroke.
- Large ball bearings on the shaft.
- Through hole in the pinion.
- Optional rubber end stroke or hydraulic shock-absorber.
- Mid position stop (MPS)

Linear Actuator Products

A complete range of pneumatic actuators

Actuator Products
A complete range of pneumatic actuators

Parker

ERIND YOU

Parker is the world leader in motion and control technologies, providing systematic, precision-engineered solutions for a wide variety of, industrial markets. Throughout the world, Parker Hannifin is working together with companies to make their machines more reliable and more productive. Parker products are in operation on satellites orbiting the earth: in machine tools and mobile plant; on oil rigs and refineries; in hospitals and laboratories. In fact, wherever there are machines that depend on motion or fluid control, you will find innovative and reliable Parker components and systems.

The Parker range of linear actuators encompasses both compact, lightweight and rodless versions and ISO/VDMA models. Versions specifically for the food industry both in aluminium and stainless steel and products for arduous applications in harsh environments are all featured.

Minimum Space Applications

P1G Compact Cylinders



- Ø6, 10 & 16mm Bore sizes
- Non-lube operation
- Corrosion resistant design
- Integral mounting thread
- Compact construction
- Single acting as standard.

Clamping & Locking Operations

C05 Short Stroke Cylinders



- Ø8 - 63mm bore sizes
- Short stroke providing high clamping force
- Compact dimensions for confined spaces
- Single and double acting
- Simple installation and mounting.

Light Duties in Packaging, Food and Textile

P1A Mini ISO Cylinders



- Ø10 - 25mm Bore size to ISO 6432
- Magnetic piston as standard
- End stroke buffers for long service life
- Adjustable cushioning Ø16 - 25mm Bore sizes
- Complete range of mountings & sensors
- Piston rod guidance units available.

Confined Space Applications

P1J Compact Cylinders



- Ø12 - 63mm
- Stroke lengths up to 100mm
- Single and double acting
- Magnetic piston as standard
- Compact dimensions for confined spaces
- Complete range of mountings & sensors.

Flexible Porting Options

P1M Cylinders



- Ø12 - 100mm
- Stroke lengths up to 500mm
- Single and double acting
- Magnetic piston as standard
- Flexible porting options
- Complete range of mountings & sensors.

Harsh Environments / Food Industry

P1S Stainless Steel Cylinders



- All stainless steel design
- Mini ISO 6432 Ø10 - 25mm Bore sizes
- Standard ISO 6431 Ø32 - 125mm Bore sizes
- Magnetic piston as standard
- Clean design ideal for washdown
- Adjustable end cushioning.
- Initial lubrication with food grade grease.

Resistance to Side Load

P5T Compact Cylinders



- Ø12 - 100mm bore size
- Complete cylinder with integral guidance
- Plain bearing or twin recirculating bearings
- End stop cushioning as standard
- Magnetic as standard
- Flexible porting and mounting
- Standard strokes 10 - 200mm

Light Duty Applications

P1K Cylinders



- Ø32 - 125mm Bore sizes
- Single and double acting
- Clean line profile design
- Designed for dry piston rod operation
- End stroke buffers for long service life
- Position sensing versions.

Short Stroke, High Thrust Single Acting Applications

Air Bellows



- 10 sizes Ø70 - 660mm
- Strokes from 45 - 430mm
- High thrust frictionless movement
- Single, double or triple convolutions
- Maintenance free.

General Industrial & Food Industry Versions

P1D ISO/VDMA Cylinders



- Ø32 - 125mm Bore size ISO/VDMA standard
- Double acting with adjustable end cushioning
- Magnetic piston as standard
- Flexible porting option
- Non-lube operation
- 'Clean' version for food industry
- Complete range of sensors and mountings

Clamping & Tightening

Hydraulic Clamp Cylinders



- Single acting cylinders with built-in hydro-pneumatic intensifier
- Compact size with large clamping forces up to 2700 daN (depending on air pressure)
- Operated using a compressed air supply, no special installation required
- Easy adjustment through a fully threaded body
- Simple and rapid installation

Gripping for most applications

P5G-C Robotic Grippers



- 4 sizes available
- Parallel or angular action
- Square jaw carriers
- One or two magneto-inductive sensor can be mounted on all sizes to provide signal to monitor gripper opening and closing.

Demanding Environments

P1E VDMA 24562 Cylinders



- Ø160 - 200mm Bore sizes VDMA standard
- Double acting with adjustable end cushioning
- Magnetic piston as standard
- Non-lube operation
- Tie rod construction
- Complete range of mountings & sensors.

Wide Variety of Industrial Applications

PV Rotary Actuators - Vane Type



- Double acting actuators
- Single or double vane
- Compact smooth design
- Uniform torque in both directions
- Angle adjustment and sensors available.

Hydraulic Damping Cylinder

Hydrockecks



- Range of imperial sizes
- Gives smooth control feeds
- Strokes up to 450mm

Door Actuation, Special Purpose Machinery

Rodless Cylinders



- High precision cushioning
- Flexible porting
- High efficiency sealing technology
- Integral sensor slot with enhancement strip
- Heavy load carrying capability

Clamping, Riveting & Punching Applications

C0D - C0P Thrust Cylinders



- Short stroke high thrust design
- Compact dimensions
- Diaphragm or piston versions
- Single or double acting.

Chip Mounting, Glass, Injection Mold, Sheet Metal

Vacuum



- Mini vacuum generators
- Compact "air saver" vacuum generators
- Multi-function vacuum generators with holding
- Valve and rapid release options
- Wide range of suction cups
- Wide range materials

At Parker, we're guided by a relentless drive to help our customers become more productive and achieve higher levels of profitability by engineering the best systems for their requirements. It means looking at customer applications from many angles to find new ways to create value. Whatever the motion and control technology need, Parker has the experience, breadth of product and global reach to consistently deliver. No company knows more about motion and control technology than Parker. For further info call 00800 27 27 5374.



AEROSPACE
Key Markets

- Aircraft engines
- Business & general aviation
- Commercial transports
- Land-based weapons systems
- Military aircraft
- Missiles & launch vehicles
- Regional transports
- Unmanned aerial vehicles

Key Products

- Flight control systems & components
- Fluid conveyance systems
- Fluid metering delivery & atomization devices
- Fuel systems & components
- Hydraulic systems & components
- Inert nitrogen generating systems
- Pneumatic systems & components
- Wheels & brakes



CLIMATE CONTROL
Key Markets

- Agriculture
- Air conditioning
- Food, beverage & dairy
- Life sciences & medical
- Precision cooling
- Processing
- Transportation

Key Products

- CO₂ controls
- Electronic controllers
- Filter driers
- Hand shut-off valves
- Hose & fittings
- Pressure regulating valves
- Refrigerant distributors
- Safety relief valves
- Solenoid valves
- Thermostatic expansion valves



ELECTROMECHANICAL
Key Markets

- Aerospace
- Factory automation
- Food & beverage
- Life science & medical
- Machine tools
- Packaging machinery
- Paper machinery
- Plastics machinery & converting
- Primary metals
- Semiconductor & electronics
- Textile
- Wire & cable

Key Products

- AC/DC drives & systems
- Electric actuators
- Controllers
- Gantry robots
- Gearheads
- Human machine interfaces
- Industrial PCs
- Inverters
- Linear motors, slides and stages
- Precision stages
- Stepper motors
- Servo motors, drives & controls
- Structural extrusions



FILTRATION
Key Markets

- Food & beverage
- Industrial machinery
- Life sciences
- Marine
- Mobile equipment
- Oil & gas
- Power generation
- Process
- Transportation

Key Products

- Analytical gas generators
- Compressed air & gas filters
- Condition monitoring
- Engine air, fuel & oil filtration & systems
- Hydraulic, lubrication & coolant filters
- Process, chemical, water & microfiltration filters
- Nitrogen, hydrogen & zero air generators



FLUID & GAS HANDLING

Key Markets

- Aerospace
- Agriculture
- Bulk chemical handling
- Construction machinery
- Food & beverage
- Fuel & gas delivery
- Industrial machinery
- Mobile
- Oil & gas
- Transportation
- Welding

Key Products

- Brass fittings & valves
- Diagnostic equipment
- Fluid conveyance systems
- Industrial hose
- PTFE & PFA hose, tubing & plastic fittings
- Rubber & thermoplastic hose & couplings
- Tube fittings & adapters
- Quick disconnects



HYDRAULICS

Key Markets

- Aerospace
- Aerial lift
- Agriculture
- Construction machinery
- Forestry
- Industrial machinery
- Mining
- Oil & gas
- Power generation & energy
- Truck hydraulics

Key Products

- Diagnostic equipment
- Hydraulic cylinders & accumulators
- Hydraulic motors & pumps
- Hydraulic systems
- Hydraulic valves & controls
- Power take-offs
- Rubber & thermoplastic hose & couplings
- Tube fittings & adapters
- Quick disconnects



PNEUMATICS

Key Markets

- Aerospace
- Conveyor & material handling
- Factory automation
- Food & beverage
- Life science & medical
- Machine tools
- Packaging machinery
- Transportation & automotive

Key Products

- Air preparation
- Compact cylinders
- Field bus valve systems
- Grippers
- Guided cylinders
- Manifolds
- Miniature fluidics
- Pneumatic accessories
- Pneumatic actuators & grippers
- Pneumatic valves and controls
- Rodless cylinders
- Rotary actuators
- Tie rod cylinders
- Vacuum generators, cups & sensors



PROCESS CONTROL

Key Markets

- Chemical & refining
- Food, beverage & dairy
- Medical & dental
- Microelectronics
- Oil & gas
- Power generation

Key Products

- Analytical sample conditioning products & systems
- Fluoropolymer chemical delivery fittings, valves & pumps
- High purity gas delivery fittings, valves & regulators
- Instrumentation fittings, valves & regulators
- Medium pressure fittings & valves
- Process control manifolds



SEALING & SHIELDING

Key Markets

- Aerospace
- Chemical processing
- Consumer
- Energy, oil & gas
- Fluid power
- General industrial
- Information technology
- Life sciences
- Military
- Semiconductor
- Telecommunications
- Transportation

Key Products

- Dynamic seals
- Elastomeric o-rings
- EMI shielding
- Extruded & precision-cut, fabricated elastomeric seals
- Homogeneous & inserted elastomeric straps
- High temperature metal seals
- Metal & plastic retained composite seals
- Thermal management

ENGINEERING YOUR SUCCESS.

**Need
something ?**

It's



Using the Technical Catalogue CD

If you already have Adobe Acrobat 4.0
Insert the CD into your PC
Click on Parker Pneumatic PDF and the CD will run.
On the opening page are displayed the options available.

On the opening page are displayed the options available.

- 1. Search.** You may search by Part Number, Name or Product type.
- 2. Getting Started.** This displays a guide to Adobe Acrobat 4.0.
- 3. View Bookshelf.** Simple to use navigation, click on the product type and the overview of all products in that type will open. Click on the product you require and the Technical Catalogue will be displayed
- 4. Exit**
- 5. Contact us.** Lists the main Sales Offices around Europe with Telephone and Fax numbers

Using the Technical Catalogue CD, If you do not have Adobe Acrobat 4.0.

We recommend viewing this CD in Adobe Acrobat 4.0.
If you do not have Adobe Acrobat 4.0 it is available free on the CD for you to install. You will need to un-install older versions of Adobe Acrobat prior to installing version 4.0. Insert the CD into your PC
Click on Parker Pneumatic PDF and the CD will run.

Parker Worldwide

Europe, Middle East, Africa

AE – United Arab Emirates,

Dubai
Tel: +971 4 8127100
parker.me@parker.com

AT – Austria, Wiener Neustadt

Tel: +43 (0)2622 23501-0
parker.austria@parker.com

AT – Eastern Europe, Wiener

Neustadt
Tel: +43 (0)2622 23501 900
parker.easteurope@parker.com

AZ – Azerbaijan, Baku

Tel: +994 50 2233 458
parker.azerbaijan@parker.com

BE/LU – Belgium, Nivelles

Tel: +32 (0)67 280 900
parker.belgium@parker.com

BY – Belarus, Minsk

Tel: +375 17 209 9399
parker.belarus@parker.com

CH – Switzerland, Etoy

Tel: +41 (0)21 821 87 00
parker.switzerland@parker.com

CZ – Czech Republic, Klecany

Tel: +420 284 083 111
parker.czechrepublic@parker.com

DE – Germany, Kaarst

Tel: +49 (0)2131 4016 0
parker.germany@parker.com

DK – Denmark, Ballerup

Tel: +45 43 56 04 00
parker.denmark@parker.com

ES – Spain, Madrid

Tel: +34 902 330 001
parker.spain@parker.com

FI – Finland, Vantaa

Tel: +358 (0)20 753 2500
parker.finland@parker.com

FR – France, Contamine s/Arve

Tel: +33 (0)4 50 25 80 25
parker.france@parker.com

GR – Greece, Athens

Tel: +30 210 933 6450
parker.greece@parker.com

HU – Hungary, Budapest

Tel: +36 1 220 4155
parker.hungary@parker.com

IE – Ireland, Dublin

Tel: +353 (0)1 466 6370
parker.ireland@parker.com

IT – Italy, Corsico (MI)

Tel: +39 02 45 19 21
parker.italy@parker.com

KZ – Kazakhstan, Almaty

Tel: +7 7272 505 800
parker.easteurope@parker.com

NL – The Netherlands, Oldenzaal

Tel: +31 (0)541 585 000
parker.nl@parker.com

NO – Norway, Asker

Tel: +47 66 75 34 00
parker.norway@parker.com

PL – Poland, Warsaw

Tel: +48 (0)22 573 24 00
parker.poland@parker.com

PT – Portugal, Leca da Palmeira

Tel: +351 22 999 7360
parker.portugal@parker.com

RO – Romania, Bucharest

Tel: +40 21 252 1382
parker.romania@parker.com

RU – Russia, Moscow

Tel: +7 495 645-2156
parker.russia@parker.com

SE – Sweden, Spånga

Tel: +46 (0)8 59 79 50 00
parker.sweden@parker.com

SK – Slovakia, Banská Bystrica

Tel: +421 484 162 252
parker.slovakia@parker.com

SL – Slovenia, Novo Mesto

Tel: +386 7 337 6650
parker.slovenia@parker.com

TR – Turkey, Istanbul

Tel: +90 216 4997081
parker.turkey@parker.com

UA – Ukraine, Kiev

Tel: +380 44 494 2731
parker.ukraine@parker.com

UK – United Kingdom, Warwick

Tel: +44 (0)1926 317 878
parker.uk@parker.com

ZA – South Africa, Kempton Park

Tel: +27 (0)11 961 0700
parker.southafrica@parker.com

North America

CA – Canada, Milton, Ontario

Tel: +1 905 693 3000

US – USA, Cleveland

Tel: +1 216 896 3000

Asia Pacific

AU – Australia, Castle Hill

Tel: +61 (0)2-9634 7777

CN – China, Shanghai

Tel: +86 21 2899 5000

HK – Hong Kong

Tel: +852 2428 8008

IN – India, Mumbai

Tel: +91 22 6513 7081-85

JP – Japan, Tokyo

Tel: +81 (0)3 6408 3901

KR – South Korea, Seoul

Tel: +82 2 559 0400

MY – Malaysia, Shah Alam

Tel: +60 3 7849 0800

NZ – New Zealand, Mt Zealand

Tel: +64 9 574 1744

SG – Singapore

Tel: +65 6887 6300

TH – Thailand, Bangkok

Tel: +662 717 8140

TW – Taiwan, Taipei

Tel: +886 2 2298 8987

South America

AR – Argentina, Buenos Aires

Tel: +54 3327 44 4129

BR – Brazil, Sao Jose dos Campos

Tel: +55 12 4009 3500

CL – Chile, Santiago

Tel: +56 2 623 1216

MX – Mexico, Apodaca

Tel: +52 81 8156 6000

VE – Venezuela, Caracas

Tel: +58 212 238 5422

European Product Information Centre

Free phone: 00 800 27 27 5374

(from AT, BE, CH, CZ, DE, DK, EE, ES, FI, FR, IE, IL, IS, IT, LU, MT, NL, NO, PL, PT, RU, SE, SK, UK, ZA)



Parker Hannifin Ltd

Pneumatic Division Europe
The Collins Centre,
Lichfield South, Wall Island,
Birmingham Road, Lichfield.
WS14 0QP United Kingdom
Tel.: +44 (0) 1543 483800
Fax: +44 (0) 1543 483801

www.parker.com/euro_pneumatic

Your local authorized Parker distributor